

IVELA.



IVELA.

INDEX



Superfici





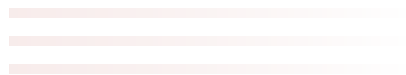

Surfaces

	Incasso Recessed	28
	Parete / plafone Wall / ceiling	36
	Sospensione Suspended	54
	Super custom	72



Linee

Lines

	Incasso Recessed	92
	Parete / plafone / terra Wall / ceiling / floor	106
	Angolare Corner	122
	Sospensione Suspended	130
	Stripled LED strips	158
	Esterni Outdoor	160
	Super custom	168



Punti

Points

	Incasso e semi-incasso Downlights and semi-recessed lights	182
	Luci a binario 48V 48V track lights	224
	Luci a binario 230V 230V track lights	244
	Luci da parete e plafone Wall / ceiling lights	268
	Sospensioni Pendants	282
	Sistemi da incasso Recessed systems	294
	Incassi per esterni Exterior recessed lights	304
	Proiettori per esterni Exterior projectors	330
	Luci da facciata / plafone Façade / exterior ceiling lights	340
	Luci da appoggio per esterni Bollards	358

Superfici Surfaces

Incasso

Recessed

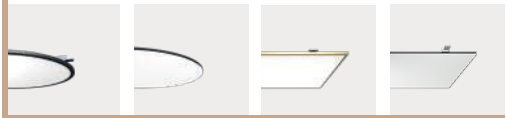

Orbital CR p. 32
Pegaso CR p. 33
Elegant SQ CR p. 34
Cristal CR p. 35

Parete / plafone

Wall / ceiling



Orbital PL p. 40
Pegaso PL p. 41
Elegant SQ PL p. 42
Cristal PL p. 43
Elegant RT PL p. 44
Soleil PL p. 45
Saturn PL p. 46

Sospensione

Suspended



Saturn D PL p. 47
Infinity PL p. 48
Elipse PL p. 49
Galactic PL p. 50
Honey PL p. 51
Elettra PL p. 52
Orbital SP p. 58
Pegaso SP p. 59
Elegant SQ SP p. 60
Cristal SP p. 61
Elegant RT SP p. 62



Soleil SP p. 63
Saturn SP p. 64
Saturn D SP p. 65
Infinity SP p. 66
Elipse SP p. 67
Galactic SP p. 68
Honey SP p. 69
Elettra SP p. 70

Super custom



Brick p. 77
Visual p. 79
Uniform p. 81
Easy p. 83

Linee Lines

Incasso

Recessed



Virgo p. 96
Scorpion IN p. 97
Lion p. 98
Pictor p. 99
Unicorn p. 100
Bear p. 101
Sagittarius p. 102
Fenice p. 104
Centaur p. 105
Orion PL p. 110
Taurus p. 112

Parete / plafone / terra

Wall / ceiling / floor



Arrow PL p. 113
Wolf p. 114
Vela p. 115
Ara PL p. 116
Dolphin PL p. 117
Cassiopea PL p. 118
Dorado PL p. 119
Mira p. 120
35 Stelo p. 121

Angolare

Corner



Aries p. 126
Lyra R p. 128

Sospensione

Suspended



Lyra S p. 129
Orion SP p. 144
Arrow SP p. 145
Ara SP p. 146
Dolphin SP p. 147
Cassiopea SP p. 148
Dorado SP p. 149
Lunae p. 150
Hula Hoop p. 151
35 Trentacinque master p. 152
35 Trentacinque continuous p. 153

Strip Led

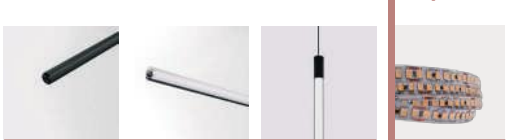

35 Trentacinque continuous off p. 154
35 Track p. 155
35 Candela p. 156
Real light striped p. 159

Esterni

Outdoor



Scorpion OUT p. 164
Capricorn p. 165
Hydra p. 166
Hydra Optics p. 167

Super custom

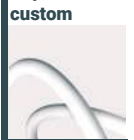

Neon tube p. 168

Incassi e semi incassi

Downlights and semi-recessed lights



Minirooler Foil p. 198	Foil track p. 199	Minirooler - IN 5 luci p. 200	Minirooler - IN 15 luci p. 201	Minirooler - TL 5 luci p. 202	Minirooler - TL 15 luci p. 203	Perfetto-IN 40 p. 204	Perfetto-IN 50 p. 204	Perfetto-IN 70 p. 205	Perfetto-IN 70 Wall washer p. 206	Perfetto-IN 60 p. 207
----------------------------------	-----------------------------	--	---	--	---	---------------------------------	---------------------------------	---------------------------------	--	---------------------------------

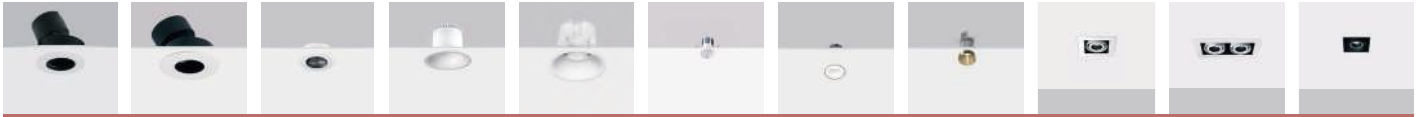

Perfetto-IN 80 p. 208	Perfetto-IN 90 p. 210	RA 7 p. 212	RA 8 Soft Dixit LED p. 212	RA 11 Soft Dixit LED p. 213	Pafo p. 214	Iside p. 216	Chloè p. 217	Kardan-IN 1 luce p. 218	Kardan-IN 2 luci p. 218	Kardan-TL 1 luce p. 219
---------------------------------	---------------------------------	-----------------------	--------------------------------------	---------------------------------------	-----------------------	------------------------	------------------------	--------------------------------------	--------------------------------------	--------------------------------------

Luci a binario 48V

48V track lights



Kardan-TL 2 luci p. 219	Nanoperfetto UP p. 220	Nanoperfetto-R p. 221	Microperfetto Large-R / ZOOM p. 222	Microperfetto Cupcake p. 223	Minirooler 48V p. 238	Linea 48 48V p. 239	Nanoperfetto 48V p. 240	Microperfetto Large 48V / ZOOM p. 241	Binario 48V quadro / square p. 242	Binario 48V incasso / recessed TL p. 243
--------------------------------------	----------------------------------	---------------------------------	---	--	------------------------------------	----------------------------------	--------------------------------------	---	---	---

Luci a binario 230V

230V track lights



Microperfetto Large LKM p. 258	Microperfetto Large Zoom LKM p. 260	Perfetto Puro LKM p. 261	Binario LKM tondo / round p. 262	Binario LKM quadro / square p. 263	Binario LKM incasso / recessed p. 265	Binario DKM quadro / square p. 266	Binario DKM incasso / recessed p. 267	Minirooler Base 10 luci p. 276	Minirooler Base 15 luci p. 277	Nanoperfetto Base p. 278
--	---	------------------------------------	--	--	---	--	---	---	---	------------------------------------

Luci da parete e plafone

Wall / ceiling lights



Sospensioni

Pendants

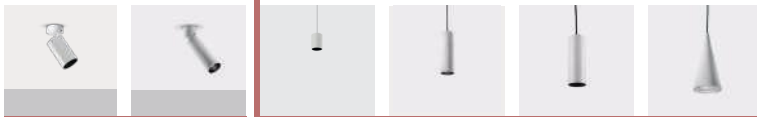

Microperfetto Large Base Zoom p. 280	Miniperfetto Base p. 281	Nanoperfetto-S p. 290	Miniperfetto-S p. 291	Perfetto Compact-S p. 291	Iconica p. 292
--	------------------------------------	---------------------------------	---------------------------------	-------------------------------------	--------------------------

Sistemi da incasso

Recessed systems



Broadway p. 300	Broadway p. 301	Microperfetto Large Broadway p. 302	Microperfetto Large Broadway ZOOM p. 302
---------------------------	---------------------------	---	--

Incassi per esterni

Exterior recessed lights



Perfetto-IN 50 IP65 p. 312	Perfetto-IN 60 IP65/20 p. 312	Perfetto-IN 90 IP66 p. 313	Perfetto-IN 90 IP66/20 p. 314	RA 8 L IP65 p. 316	RA 8 IP65 p. 316	RA 8 IP66 oscillante p. 317	Nanoperfetto IN-ground p. 318	Nanoperfetto IN-ground antiglare p. 319	Perfetto IN-ground p. 320	Perfetto IN-ground antiglare p. 321
---	--	---	--	---------------------------------	-------------------------------	--	---	---	-------------------------------------	---



Nauto con lente p. 322	Wall-cut 80 p. 323	Wall-cut 150 p. 324	Aquarius p. 326	Daisy R p. 328	Daisy S p. 329
----------------------------------	------------------------------	-------------------------------	---------------------------	--------------------------	--------------------------

Proiettori per esterni

Exterior projectors



Microperfetto IP66 p. 336	Perfetto IP66 p. 338	Dino con lente p. 339
-------------------------------------	--------------------------------	---------------------------------

Luci da facciata / plafone

Façade / exterior ceiling lights

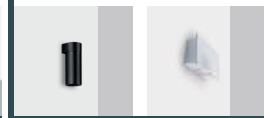

Microperfetto IP66 Applique p. 348	Balti 80 p. 350
--	---------------------------



Balti 150 p. 350	Balti 220 p. 351	Balti 260 p. 351	Bidi Applique p. 352	Microperfetto IP66 Cupeake p. 354	PN 180 p. 356	PN 230 p. 356	PN 210 p. 357	PN 280 p. 357
----------------------------	----------------------------	----------------------------	--------------------------------	---	-------------------------	-------------------------	-------------------------	-------------------------

Luci da appoggio per esterni

Bollards



Microperfetto IP66 stelo p. 366	Pole-cut 80 p. 367
---	------------------------------

Crediamo nel potere della scelta.
Offriamo ai designer soluzioni minimaliste
che si aprono a nuove e infinite possibilità
progettuali.
Forme pure, linee pulite e aperture gentili che
generano precise performance luminose.

Light in your hands.

We believe in empowering choice. We provide designers minimalist
products with a multitude of options. Pure shapes, clean lines and gentle
apertures that deliver precise performance where needed.

Lights in your hands.

● ○ ◎ ○ We believe
▬ ▬▬▬▬ in empowering
■ ▯ ▭ choice

Our – values

Tecnologia digitale e customizzazione per una luce connessa, su misura e sostenibile.

Digital technology and customization for a connected tailor-made and sustainable light.

Controllo

Control

Sviluppo tecnologico e performance elevate come impulso verso l'eccellenza.

Technological development and high performance as a boost to excellence.

Personalizzazione

Customization

Attenzione al dettaglio e la ricerca dei migliori materiali come essenza del progresso.

Attention to details and the best supplies research as essence of our progress.

Made in Milan

Siamo a Milano, dove respiriamo la storia del design.

Milan based, we participate in the design history of the city.



Wireless lighting controls

ZETAQLAB
Lighting Control Expert

^{ITA} Ci siamo affidati al miglior partner possibile per lo sviluppo dei sistemi di controllo dell'illuminazione: ZETAQLAB azienda di Starlight Group specializzata nella gestione digitale della luce, soprattutto con tecnologie wireless. Crediamo nel benessere che anche la luce porta: le nuove tecnologie ci aiuteranno ad ottimizzare risorse, ridurre al minimo gli sprechi e diminuire i costi. Gestire gli spazi in modi smart faciliterà e semplificherà ogni progetto. Lo sviluppo di sistemi di gestione e controllo dell'illuminazione 100% Made in Italy, con prodotti interconnessi tra loro da poter utilizzare sia in modalità indipendente (stand-alone) che aggregata è una soluzione disponibile per tutte le Superfici, le Linee e alcuni prodotti della collezione Punti.

^{EN} We relied on the best possible partnership for the development of lighting control systems: ZetaQLab, a company of Starlight Group expert in digital light management, primarily with wireless technologies. We believe in well-being through light: new technologies will help us to optimize resources, minimize waste and reduce costs. Managing spaces in smart ways will facilitate and simplify every project. The development of 100% Made in Italy lighting management and control systems, with interconnected products that can be used both independently (stand-alone) and aggregated, is a solution available for all Surfaces, Lines and some products from the Points collection.

Per approfondimenti, visitate il sito
www.zetaqlab.com

For more information, visit
www.zetaqlab.com



La luce prende forma: connessa, intuitiva, essenziale

Light takes shape: connected, intuitive, essential.

Protocolli wireless standard per l'illuminazione

Grazie a Bluetooth LE e Zigbee 3,0 è possibile controllare gli apparecchi di illuminazione via Smartphone.

Doppia tecnologia wireless

I sistemi ZETAQLAB sono equipaggiati con un'interfaccia Wireless Mesh Network 2.4 GHz con doppia tecnologia Bluetooth LE e Zigbee 3.0, che permette simultaneamente la connessione dello smartphone via Bluetooth e l'interconnessione dei nodi di sistema via Zigbee.

Standard wireless protocols for lighting

Thanks to Bluetooth LE and Zigbee 3.0 it is possible to manage the luminaires via Smartphone.

Double wireless technologies

The ZETAQLAB systems are equipped with a 2.4 GHz Wireless Mesh Network interface with dual Bluetooth LE and Zigbee 3.0 technology, which simultaneously allows the connection of mobile devices via Bluetooth and the interconnection of the system nodes via Zigbee.



Cerca il simbolo all'interno del catalogo e scopri quali prodotti possono essere gestiti dall'app.

Look for the symbol in the catalog and find out which products can be managed by the app.

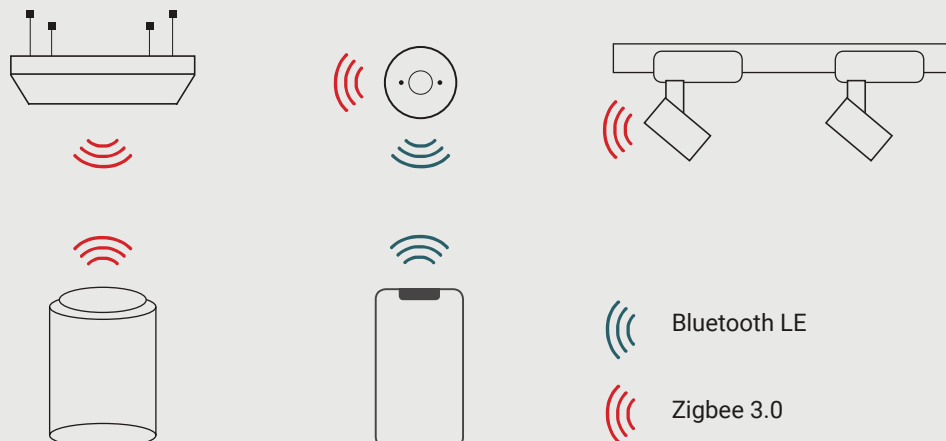

Light 360 Setup

l'APP semplice, intuitiva e professionale

easy, intuitive and professional APP

Caratteristiche

Features

- **Crea gruppi di punti luce, sensori e pulsantiere**
Group luminaires, sensors and push buttons
- **Regola il livello luminoso e la temperatura di colore**
Adjust the dimming level and color temperature
- **Configurare i parametri dei sensori**
Configure parameters for sensors
- **Imposta le scene e le modalità di lavoro automatiche**
Set scenes and automatic working modes
- **Richiedi supporto tecnico remoto in-app**
Request in-app remote technical support
- **Verifica lo stato dell'illuminazione di emergenza**
Check emergency lighting status
- **Controlla e gestisci il sistema**
Control and manage the system

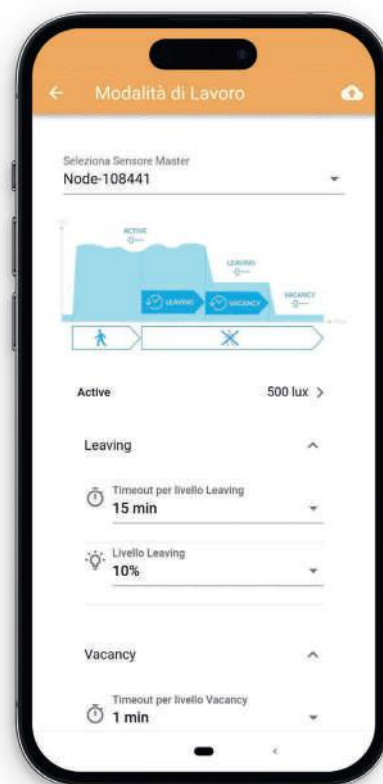

App gratuita per smartphone, sviluppata per l'installazione e la gestione dei sistemi.

Free App for mobile devices for setup and manage the systems.



Apple



Android



Connetti il tuo smartphone al sistema tramite Bluetooth

Connect your smartphone to the system via Bluetooth



Crea gruppi di apparecchi, sensori, attuatori ed interfacce di comando

Create groups of luminaires, sensors, actuators and control interfaces



Crea scene ed imposta i parametri di lavoro per le modalità di gestione automatiche

Set the parameters for automatic working modes and create scenes

Funzionalità

functionality

esperienze di luce

light experiences

Imposta semplicemente tramite App la perfetta atmosfera e le scene di luce con controllo automatico o manuale.

Get the perfect light mood and scenes with automatic or manual control, changing them easily with the App.

automazione

automation

Il sistema adatta il livello di luce in base alla presenza di persone ed al contributo di luce naturale, utilizzando sensori di movimento e luminosità.

The system adapts the light level according to presence of people and daylight using motion and ambient light sensors.

emergenza

emergency

Test report automatizzati e centralizzati per l'illuminazione di emergenza, come richiesto dagli standard internazionali.

Automated and centralized test reports for emergency lighting, as required by international standards.

scalabilità

scalability

Il nostro sistema è adatto sia per piccole e semplici installazioni, come ad esempio un ufficio o negozio, fino a grandi progetti multi-site centralizzati via software.

Our system is suitable for a small and simple installation, like a single office or shop, up to large and multi-site projects centralized via software.

Prodotti

products

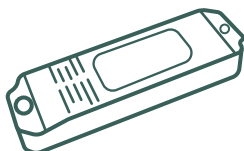

DALI control unit

Trasforma un apparecchio DALI standard in wireless

Turn a standard DALI luminaire into wireless

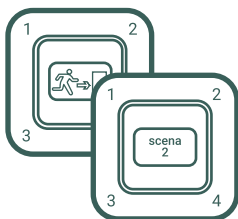

Keypads

Richiama le scene e imposta la tua atmosfera luminosa tramite wireless

Recall scenes and set your own lighting mood via wireless

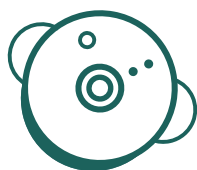

Multisensor

Automatizza il tuo sistema con sensori wireless di movimento e luminosità

Automate your system with wireless motion and ambient light sensors

Contattaci per ulteriori informazioni.

Contact us for further info.

Customization service

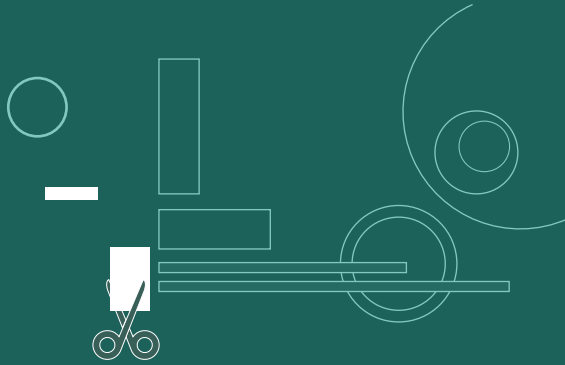

Light is made of uniqueness

^{ITA} I tuoi progetti sono unici, come te. La nostra competenza e le tecnologie che utilizziamo rendono unici i nostri prodotti secondo le esigenze specifiche dei tuoi progetti. Un servizio sartoriale, dedicato esclusivamente ai progetti speciali, che richiedono un'attenzione e una cura particolari.

Abbiamo fatto della personalizzazione e della qualità i nostri punti di forza: il nostro servizio di customizzazione è in grado di costruire ogni prodotto intorno alle tue esigenze.

^{EN} **Your projects are unique, like you.** Our expertise and the technologies we use to make our creations distinctive according to the specific needs of your projects. This bespoke service is dedicated exclusively to your projects which require exceptional engagement and care.

Personalization and quality are our strengths: our customization service builds each fitting around your demands.



One light, infinite possibilities



BRICK con finitura cromo / with chrome finishing (in alto / above)
 EASY super custom (a destra / on the right)
 VISUAL super custom (a sinistra / on the left)

^{ITA} Ogni prodotto custom nasce dai sogni e dalle esigenze dei nostri clienti. Il nostro team di tecnici e progettisti riesce a coglierne l'essenza e ne studia la perfetta messa in opera. Possiamo realizzare su misura apparecchi di illuminazione secondo specifiche richieste custom: pannelli LED, linee di luce, grandi installazioni e composizioni di luce modulari.

^{EN} Each custom product is born from the dreams and requirements of our customers. Our engineers and designers can grasp the essence of the projects and develop their perfect implementation. We can tailor-make lighting fixtures according to specific custom requests: LED panels, linear light lines, large installations and modular light compositions.



Light, as you want it

^{ITA} Grazie al know-how, alle tecnologie e ai materiali sapientemente scelti, realizziamo prodotti di qualità altamente efficienti e di design. Con un approccio di servizio just-in-time e grazie alla flessibilità di gamma offerta, soddisfiamo sempre le diverse richieste dei clienti ai quali, inoltre, mettiamo a disposizione le nostre conoscenze e l'esperienza maturata nel settore attraverso studi di fattibilità, progettazione e risoluzione di problemi.

^{EN} We create high-quality and efficient products thanks to the know-how, technologies and carefully chosen materials. With a just-in-time service approach and the flexibility of the range offered, we always satisfy the different demands of our customers. We provide our knowledge and long experience achieved in the lighting sector through feasibility studies, design and problem-solving.



Cerca il simbolo all'interno del catalogo e scopri quali prodotti possono essere gestiti dall'app.

Look for the symbol in the catalog and find out which products can be managed by the app.

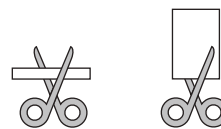

Per ogni richiesta e domande sul nostro servizio di progettazione e produzione tailor-made, vi invitiamo a contattare il nostro servizio clienti scrivendo una email a info@ivela.it

Saremo lieti di trovare le migliori soluzioni per i vostri progetti più esclusivi.

We invite you to contact our customer service for any requests and questions about our tailor-made design and production service by writing an email to info@ivela.it

We will find the best solutions for your most exclusive projects.

Limitless solutions

^{ITA} La nostra area produttiva nei pressi di Brescia è dotata di macchinari all'avanguardia per poter eseguire ogni tipo di lavorazione: taglio laser, frese a controllo numerico, taglio e piega di lamiera, macchine per la serigrafia, stampanti digitali, incisione di circuiti stampati, montaggio di componenti elettronici, saldatura e reparti di collaudo. **Ogni richiesta viene attentamente studiata e presa in considerazione, per garantire risposte rapide, qualificate, flessibili. Sempre.**

^{EN} Our production factory near Brescia has cutting-edge machinery that can perform any processing: laser cutting, numerical control milling machines, sheet metal cutting and bending, screen printing machines, digital printers, printed circuit board engraving, assembly of electronic components, welding and testing departments. **Our strengths are service and customization of the product and the study of each component to ensure quick, qualified and flexible responses. Always.**



BRICK (in alto / above)
UNIFORM super custom (a sinistra / on the left)

Le nostre personalizzazioni

Our customizations



DIMENSIONI
SIZES



FORME
SHAPES



FINITURE
FINISHES



CONTROLLO
CONTROL SYSTEM



DIMMERAZIONE
DIMMING



CARATTERISTICHE
ILLUMINOTECNICHE
LIGHTING FEATURES

Punti Linee Superfici

Points
Lines
Surfaces



CONCEPT 2023

"La linea geometrica è un ente invisibile.

Essa è la traccia lasciata dal punto in movimento, quindi un suo prodotto. Essa è sorta dal movimento - e precisamente attraverso l'annientamento della quiete suprema in sé conclusa nel punto.

Qui ha luogo il salto dalla staticità al dinamismo.

Il punto fa presa sulla superficie e vi si stabilisce per sempre.

Così: esso è internamente la più concisa affermazione stabile, che sorge breve, ferma e rapida."

"The geometric line is an invisible thing.

It is the track made by the moving point; that is, its product. It is created by movement - specifically through the destruction of the intense self-contained repose of the point. Here, the leap out of the static to the dynamic occurs.

The point grips the plane and settles there forever. Thus: it is internally the most concise stable statement, arising short, firm and rapid."

V. Kandinskij

Content

Disegnare la luce per IVELA significa offrire la possibilità di vivere gli spazi interni ed esterni in comodità e serenità ma, in realtà, significa molto di più.

Significa assecondare lo sguardo di chi vive gli ambienti, regalare un'esperienza visiva e gestire la luce secondo ogni specifica esigenza.

Proprio come quando un pittore tocca la tela per la prima volta, si genera un **Punto**, che è il primo nucleo del significato di una composizione ed è statico. La **Linea**, al contrario, è dinamica ed è la traccia lasciata dal punto in movimento. Essa può assumere orientamenti e spessori diversi, passare da orizzontale, verticale a diagonale, ma può anche essere spezzata, curva, mista.

La **Superficie** rappresenta il supporto materiale che contiene l'opera, ma anche lo spazio a disposizione per l'immaginazione.

Designing light for IVELA means showing the potential of experiencing indoor and outdoor spaces in comfort and serenity, but in reality, it means much more.

It means indulging the gaze of those who live in the spaces, offering a visual experience and managing the light according to each specific requirement.

A **Point** comes to life, just like when a painter touches the canvas for the first time. It is the first core of the meaning of a composition and is static. The **Line**, on the contrary, is dynamic and is the trace left by the moving point. It can assume different orientations and thicknesses. It can go from horizontal, vertical to diagonal. You can break, bend, mix it. The **Surface** represents the material support that contains the work of art and the space available for the imagination.

Superfici LED - uniformi e brillanti

Linee di luce - sottili e leggere

Punti d'accento - precisi e performanti

Effetti di luce diversi, diverse percezioni.

Un solo modo armonico di concepire la luce.

LED Surfaces - uniform and brilliant

Lines of light - thin and light

Accent points - precise and performing

Different light effects, different perceptions.

Only one harmonious way of conceiving light.

Superfici

Surfaces

“Una retta, e in particolare una breve retta che si ispessisce, rappresenta un caso analogo a quello del punto che cresce: anche qui c’è da domandarsi: in quale momento si estingue la linea come tale e in quale momento nasce una superficie?”

“A straight line, and in particular a short straight line that thickens, represents a case analogous to that of the point that grows: here too we must ask ourselves: at what moment does the line as such extinguish and at what moment does a surface ?”

V. Kandinskij



Saturn SP



Il puro piacere della luce

Pure lighting pleasure

^{ITA} Forme geometriche piane, che prendono vita grazie alla luce di sorgenti LED di ultima generazione. Superfici di luce super sottili caratterizzate da un'emissione diffusa e omogenea. Nomi che evocano eleganza ed elementi naturali associati agli spazi infiniti dell'universo. Superfici brillanti e dalle possibilità quasi infinite.

Totalmente personalizzabili, si distinguono per il loro design puro e minimale. Performance tecniche di alto livello, soluzioni di luce innovative che consentono un'ampia versatilità compositiva.

^{EN} Flat geometric shapes come to life thanks to the light of the latest generation LED sources, Super thin light surfaces featuring a diffused and homogeneous emission. Their names evoke the elegance and natural elements associated with the infinite spaces of the universe. These brilliant surfaces have almost endless possibilities.

Fully customizable, they stand out for their pure and minimal design: high-level technical performance and innovative lighting solutions that allow a wide compositional versatility.



Orbital PL (in alto / above)
Pegaso PL (a sinistra / on the left)

Un approccio olistico a luce e architettura

A holistic approach to light and architecture

^{ITA} Se il design delle Superfici si caratterizza per la sua purezza di forme ed essenzialità, la gamma dei prodotti è invece decisamente ricca:

^{EN} If the purity of forms and essentiality distinguish the design of the Surfaces, its product range is rich:

- **5 differenti forme (tonda, quadrata, rettangolare, esagonale ed ellittica).**
5 different shapes (round, square, rectangular, hexagonal and elliptical).
- **a superficie piena o con taglio centrale oppure decentrato.**
total surface or with central or off-centre cut.
- **con cornice oppure con diffusore visibile anche sulla parte perimetrale per una diffusione della luce uniforme e scenografica.**
with a frame or with a diffuser also visible on the perimeter for a uniform and scenographic diffusion of light.
- **3 finiture standard (bianco, nero e oro), con possibilità di personalizzazione, su richiesta.**
3 standard finishes (white, black and gold), with the possibility of personalization, upon request.
- **4 diverse applicazioni (incasso, plafone/parete, sospeso, SuperCustom)**
4 different applications (recessed, ceiling/wall, suspended, SuperCustom)



Galactic PL

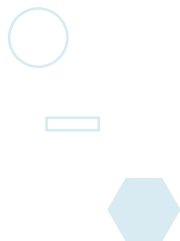

Equilibrio tra forma e funzione

Balanced form and function

^{ITA} Le nostre Superfici si caratterizzano da una struttura estremamente sottile, che non supera i 20 millimetri di spessore.

L'innovativa tecnologia alla base dei nostri prodotti consente un'efficienza luminosa senza abbagliamento, ideale in strutture ricettive e uffici.

Un'illuminazione perfettamente uniforme e omogenea su tutta la superficie dei nostri diffusori opale, indipendentemente dalla sua dimensione, forma e spessore, frutto di anni di ricerche del nostro team interno.

Le Superfici diventano la soluzione ideale e versatile per illuminare con creatività ambienti residenziali, hospitality, retail ma anche aree professionali di grandi dimensioni.

^{EN} Our Surfaces feature an extremely shallow structure, which does not exceed 20 millimetres in thickness.

The innovative technology behind our products allows for glare-free luminous efficiency, ideal in accommodation facilities and offices.

Our team has studied for years to grant perfectly uniform and homogeneous lighting over the entire surface of our opal diffusers, regardless of their size, shape and thickness.

Surfaces are the ideal and versatile solution for creatively illuminating residential, hospitality, retail, and professional areas.

Collezione ad alto valore aggiunto

Collection with a high added value





Honey SP (in alto / above)
Galactic SP (a sinistra / on the left)

^{ITA} I prodotti della collezione Superfici sono completamente customizzabili. Potete richiedere personalizzazioni di dimensione, finitura, forma, e specifiche illuminotecniche. Tutte le superfici prevedono la possibilità di regolazione e controllo remoto, in base alle più diverse esigenze.

Il nostro servizio clienti è a disposizione per valutare insieme ogni vostra richiesta speciale e progettare il prodotto più adatto a soddisfarla.

^{EN} The products in the Surfaces collection are fully customizable. You can request tailor-made manufacturing of size, finish, shape, and lighting specifications. All surfaces provide for the possibility of dimming and remote control based on the most various needs.

Our customer service is available to assess all your special requests and develop the most suitable product to fulfil them.



01

Superfici incasso

recessed

Forme minimali da accarezzare con gli occhi

Minimal shapes to caress with the eyes

^{ITA} Appositamente progettati per l'installazione in controsoffitti, vedono la loro principale applicazione in spazi commerciali o di lavoro come: hotel, ristoranti, supermercati, sale espositive, musei o uffici.

Garantiscono una luce di ottima qualità e molto uniforme, illuminando in modo pulito gli ambienti mantenendo un'elevata efficienza luminosa, senza abbagliare. Gli incassi trasformano con eleganza la personalità dell'ambiente e si fondono con discrezione nell'architettura degli spazi.

^{EN} Specially designed for false ceiling installation, they can be installed mainly in commercial or work spaces such as hotels, restaurants, supermarkets, exhibition halls, museums or offices.

They guarantee excellent quality and very uniform light, illuminating environments cleanly while maintaining high luminous efficiency without glare.

The recessed surfaces transform the personality of the environment with elegance and blend discreetly into the architecture of the spaces.





Cristal CR (in alto / above)
Elegant SQ CR (a sinistra / on the left)

01

Superfici

incasso

recessed



	Products	Pages
	Orbital CR	32
	Pegaso CR	33
	Elegant SQ CR	34
	Cristal CR	35

ORBITAL CR

INCASSO / RECESSED



01 Bianco White 02 Nero Black 07 Oro Gold

Codice base Base code	Ottica Optic	Fissaggio Fixing	Colour T (K)	Finitura Finish	Chiusura Closing
--------------------------	-----------------	---------------------	-----------------	--------------------	---------------------

Variante da comporre a seconda delle proprie necessità
Variant to compose according to your needs.

OR -	O opale / opal	CR	Z 2700K	01	D070
	P prismatico / prismatic		C 3000K	02	D090
			N 4000K	07	D120

24Vdc

CE IP20



Caratteristiche illuminotecniche / Lighting specifications

Dimensione Size (mm)	LED Lumen	Product Lumen	Watt	Vdc	Colour T	CRI
Ø707	5280	3168	44	24	2700	93
	5500	3300	44	24	3000	93
	5830	3498	44	24	4000	93
Ø899	6720	4032	56	24	2700	93
	7000	4200	56	24	3000	93
	7420	4452	56	24	4000	93
Ø1216	9120	5472	76	24	2700	93
	9500	5700	76	24	3000	93
	10070	6042	76	24	4000	93

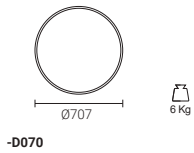

-D070

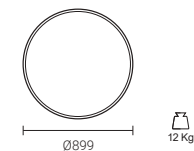

-D090

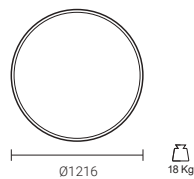

-D120

15 (+/- 1mm)

Driver da ordinare separatamente / Drivers to be ordered separately

AL00179 Output 24Vdc 150W
On/Off

Controller da ordinare separatamente / Controller to be ordered separately

CT00050 Dimmer 1 ch
DALI2-PUSH-0/1..10V

CT00052 Dimmer 1 ch
PUSH/WIRELESS

Reference configurator

Il codice prodotto si compone mettendo in fila, da sinistra a destra, i dati contenuti nelle colonne a partire da "Codice base".

The product code is created by putting in sequence the data starting from "Base code", from left to right.

es: OR-OCRN07D120



PEGASO CR

INCASSO / RECESSED

Incassi Recessed



01 Bianco White 02 Nero Black 07 Oro Gold

Codice base Ottica Fissaggio Colour Finitura Chiusura
Base code Optic Fixing T (K) Finish Closing

Variante da comporre a seconda delle proprie necessità
Variant to compose according to your needs.

PG -	O opale / opal	CR	Z 2700K	01	D060
			C 3000K	02	D090
			N 4000K	07	D120

24Vdc

CE IP20

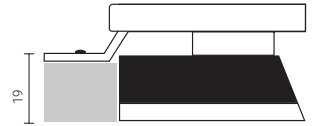

Caratteristiche illuminotecniche / Lighting specifications

Dimensione Size (mm)	LED Lumen	Product Lumen	Watt	Vdc	Colour T	CRI
Ø612	4320	2160	38	24	2700	93
	4500	2250	38	24	3000	93
	4770	2385	38	24	4000	93
Ø899	6720	3360	56	24	2700	93
	7000	3500	56	24	3000	93
	7420	3710	56	24	4000	93
Ø1216	9120	4560	76	24	2700	93
	9500	4750	76	24	3000	93
	10070	5035	76	24	4000	93

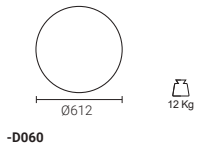

-D060

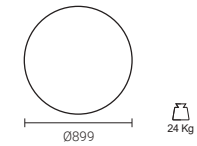

-D090

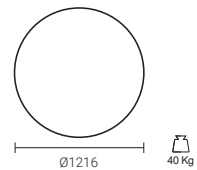

-D120

19 (+/- 1mm)

Driver da ordinare separatamente / Drivers to be ordered separately

AL00179 Output 24Vdc 150W
On/Off

Controller da ordinare separatamente / Controller to be ordered separately

CT00050 Dimmer 1 ch
DALI2-PUSH-0/1..10V

CT00052 Dimmer 1 ch
PUSH/WIRELESS

Reference configurator

Il codice prodotto si compone mettendo in fila, da sinistra a destra, i dati contenuti nelle colonne a partire da "Codice base".

The product code is created by putting in sequence the data starting from "Base code", from left to right.

es: PG-OCRN07D120



ELEGANT SQ CR

INCASSO / RECESSED



01 Bianco White 02 Nero Black 07 Oro Gold

Codice base Base code	Ottica Optic	Fissaggio Fixing	Colour T (K)	Finitura Finish	Chiusura Closing
--------------------------	-----------------	---------------------	-----------------	--------------------	---------------------

Variante da comporre a seconda delle proprie necessità
Variant to compose according to your needs.

ELG -	O opale / opal	CR	Z 2700K	01	L066
	P prismatico / prismatic		C 3000K	02	L091
			N 4000K	07	L111

24Vdc

CE IP20



Caratteristiche illuminotecniche / Lighting specifications

Dimensione Size (mm)	LED Lumen	Product Lumen	Watt	Vdc	Colour T	CRI
610x610	5760	3456	48	24	2700	93
	6000	3600	48	24	3000	93
	6360	3816	48	24	4000	93
910x910	8640	5184	72	24	2700	93
	9000	5400	72	24	3000	93
	9540	5724	72	24	4000	93
1110x1110	10560	6336	80	24	2700	93
	11000	6600	80	24	3000	93
	11660	6996	80	24	4000	93

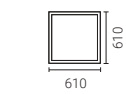

7 Kg

-L066

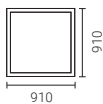

11 Kg

-L091

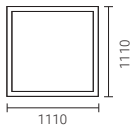

20 Kg

-L111

27 (+/- 1mm)

Driver da ordinare separatamente / Drivers to be ordered separately

AL00179 Output 24Vdc 150W
On/Off

Controller da ordinare separatamente / Controller to be ordered separately

CT00050 Dimmer 1 ch
DALI2-PUSH-0/1..10V

CT00052 Dimmer 1 ch
PUSH/WIRELESS

Reference configurator

Il codice prodotto si compone mettendo in fila, da sinistra a destra, i dati contenuti nelle colonne a partire da "Codice base".

The product code is created by putting in sequence the data starting from "Base code", from left to right.

es: ELG-OCRN07L111



CRISTAL CR

INCASSO / RECESSED

Incassi Recessed

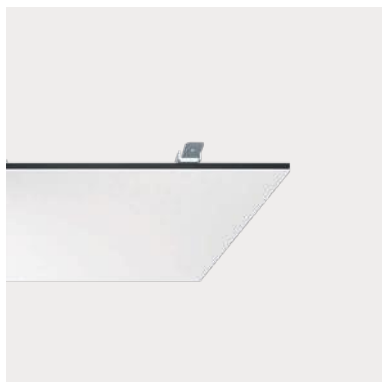

01 Bianco White 02 Nero Black 07 Oro Gold

Codice base Base code **Ottica** Optic **Fissaggio** Fixing **Colour** T (K) **Finitura** Finish **Chiusura** Closing

Variante da comporre a seconda delle proprie necessità
Variant to compose according to your needs.

CR -	O opale / opal	CR	Z 2700K	01	L066
			C 3000K	02	L099
			N 4000K	07	L121

24Vdc

CE IP20



Caratteristiche illuminotecniche / Lighting specifications

Dimensione Size (mm)	LED Lumen	Product Lumen	Watt	Vdc	Colour T	CRI
620x620	5760	2880	48	24	2700	93
	6000	3000	48	24	3000	93
	6360	3180	48	24	4000	93
920x920	8640	4320	72	24	2700	93
	9000	4500	72	24	3000	93
	9540	4770	72	24	4000	93
1220x1220	11520	5760	96	24	2700	93
	12000	6000	96	24	3000	93
	12720	6360	96	24	4000	93

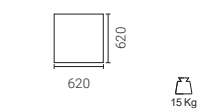

-L066

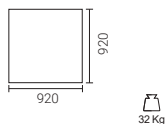

-L099

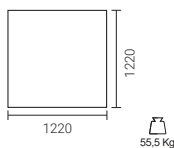

-L121

19 (+/- 1mm)

Driver da ordinare separatamente / Drivers to be ordered separately

AL00179 Output 24Vdc 150W
On/Off

Controller da ordinare separatamente / Controller to be ordered separately

CT00050 Dimmer 1 ch
DALI2-PUSH-0/1..10V

CT00052 Dimmer 1 ch
PUSH/WIRELESS

Reference configurator

Il codice prodotto si compone mettendo in fila, da sinistra a destra, i dati contenuti nelle colonne a partire da "Codice base".

The product code is created by putting in sequence the data starting from "Base code", from left to right.

es: CR-OCRN02L099





02

Superfici parete / plafone

wall / ceiling

Sinergie creative tra architettura, luce e design

Creative synergies among architecture, light and design

^{ITA} Ideali per l'installazione in ambienti in cui non si dispone di un soffitto pannellato oppure non si desidera tagliare il soffitto o le pareti per l'installazione a incasso. Queste particolari Superfici sono la moderna evoluzione di plafoniere e applique: un prodotto versatile al servizio delle richieste più esigenti, che abbraccia ogni spazio e ogni dimensione.

Questo tipo di soluzione è molto comune in grandi spazi come ristoranti, alberghi, supermercati, sale espositive, o musei. È utilizzato anche in ambienti di lavoro dove la qualità della luce è un fattore fondamentale, senza dimenticare applicazioni squisitamente residenziali o retail.

^{EN} They are ideal for installation where you do not have a panelled ceiling or do not want to cut into the ceiling or walls for recessed installation.

These particular Surfaces are the modern evolution of ceiling and wall lamps: a versatile product at the service of the most demanding requests, which embraces every space and every dimension.

This solution is common in large spaces such as restaurants, hotels, supermarkets, exhibition halls or museums. It can be used in work settings where the quality of light is a fundamental factor, without forgetting purely residential or retail applications.





Elettra PL (in alto / above)
Elegant RT PL - Elegant SQ PL (a sinistra / on the left)













02

Superfici

parete / plafone

wall / ceiling



	Products	Pages
	Orbital PL	40
	Pegaso PL	41
	Elegant SQ PL	42
	Cristal PL	43
	Elegant RT PL	44
	Soleil PL	45
	Saturn PL	46
	Saturn D PL	47
	Infinity PL	48
	Elipse PL	49
	Galactic PL	50
	Honey PL	51
	Elettra PL	52

ORBITAL PL

PLAFONE/CEILING/WALL



01 Bianco White 02 Nero Black 07 Oro Gold

Codice base Base code	Ottica Optic	Fissaggio Fixing	Colour T (K)	Finitura Finish	Chiusura Closing
--------------------------	-----------------	---------------------	-----------------	--------------------	---------------------

Variante da comporre a seconda delle proprie necessità
Variant to compose according to your needs.

OR -	O opale / opal	PL	Z 2700K	01	D070
	P prismatico / prismatic		C 3000K	02	D090
			N 4000K	07	D120

24Vdc

CE IP20

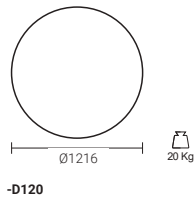
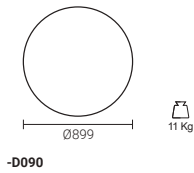
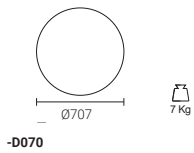
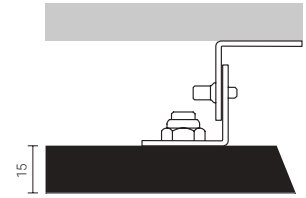

15 (+/- 1mm)

Caratteristiche illuminotecniche / Lighting specifications

Dimensione Size (mm)	LED Lumen	Product Lumen	Watt	Vdc	Colour T	CRI
Ø707	5280	3168	44	24	2700	93
	5500	3300	44	24	3000	93
	5830	3498	44	24	4000	93
Ø899	6720	4032	56	24	2700	93
	7000	4200	56	24	3000	93
	7420	4452	56	24	4000	93
Ø1216	9120	5472	76	24	2700	93
	9500	5700	76	24	3000	93
	10070	6042	76	24	4000	93

Driver da ordinare separatamente / Drivers to be ordered separately

AL00179 Output 24Vdc 150W
On/Off

Controller da ordinare separatamente / Controller to be ordered separately

CT00050 Dimmer 1 ch
DALI2-PUSH-0/1..10V

CT00052 Dimmer 1 ch
PUSH/WIRELESS

Reference configurator

Il codice prodotto si compone mettendo in fila, da sinistra a destra, i dati contenuti nelle colonne a partire da "Codice base".

The product code is created by putting in sequence the data starting from "Base code", from left to right.

es: OR-OPLN01D120



PEGASO PL

PLAFONE/CEILING/WALL

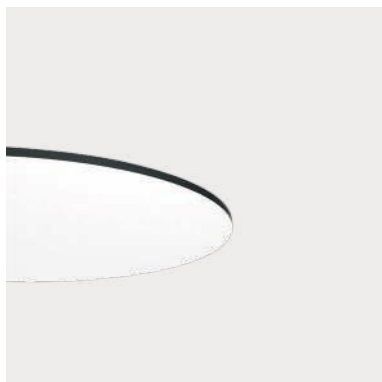

01 Bianco White 02 Nero Black 07 Oro Gold

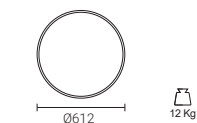

-D060

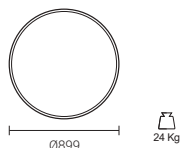

-D090

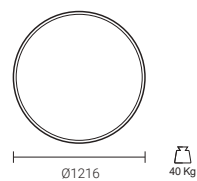

-D120

19 (+/- 1mm)

Reference configurator

Il codice prodotto si compone mettendo in fila, da sinistra a destra, i dati contenuti nelle colonne a partire da "Codice base".

The product code is created by putting in sequence the data starting from "Base code", from left to right.

es: PG-OPLN02D090



Codice base Base code	Ottica Optic	Fissaggio Fixing	Colour T (K)	Finitura Finish	Chiusura Closing
--------------------------	-----------------	---------------------	-----------------	--------------------	---------------------

Variante da comporre a seconda delle proprie necessità
Variant to compose according to your needs.

PG -	O opale / opal	PL	Z 2700K	01	D060
			C 3000K	02	D090
			N 4000K	07	D120

24Vdc

CE IP20

Parete / plafone Wall / ceiling

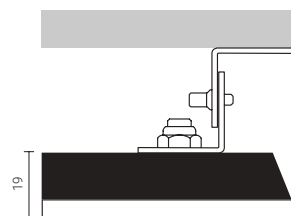

Caratteristiche illuminotecniche / Lighting specifications

Dimensione Size (mm)	LED Lumen	Product Lumen	Watt	Vdc	Colour T	CRI
Ø612	4320	2160	38	24	2700	93
	4500	2250	38	24	3000	93
	4770	2385	38	24	4000	93
Ø899	6720	3360	56	24	2700	93
	7000	3500	56	24	3000	93
	7420	3710	56	24	4000	93
Ø1216	9120	4560	76	24	2700	93
	9500	4750	76	24	3000	93
	10070	5035	76	24	4000	93

Driver da ordinare separatamente / Drivers to be ordered separately

AL00179 Output 24Vdc 150W
On/Off

Controller da ordinare separatamente / Controller to be ordered separately

CT00050 Dimmer 1 ch
DALI2-PUSH-0/1..10V

CT00052 Dimmer 1 ch
PUSH/WIRELESS

ELEGANT RT PL

PLAFONE/CEILING/WALL



01 Bianco White 02 Nero Black 07 Oro Gold

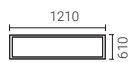

11 Kg

-L126

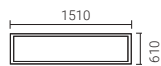

14 Kg

-L156

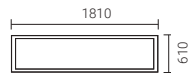

16 Kg

-L186

27 (+/- 1mm)

Reference configurator

Il codice prodotto si compone mettendo in fila, da sinistra a destra, i dati contenuti nelle colonne a partire da "Codice base".

The product code is created by putting in sequence the data starting from "Base code", from left to right.

es: ELG-OPLN07L186



Codice base Base code	Ottica Optic	Fissaggio Fixing	Colour T (K)	Finitura Finish	Chiusura Closing
--------------------------	-----------------	---------------------	-----------------	--------------------	---------------------

Variante da comporre a seconda delle proprie necessità
Variant to compose according to your needs.

ELG -	O opale / opal	PL	Z 2700K	01	L126
	P prismatico / prismatic		C 3000K	02	L156
			N 4000K	07	L186

24Vdc



Caratteristiche illuminotecniche / Lighting specifications

Dimensione Size (mm)	LED Lumen	Product Lumen	Watt	Vdc	Colour T	CRI
1210x610	5760	3456	48	24	2700	93
	6000	3600	48	24	3000	93
	6360	3816	48	24	4000	93
1510x910	7200	4320	60	24	2700	93
	7500	4500	60	24	3000	93
	7950	4770	60	24	4000	93
1810x610	8640	4320	72	24	2700	93
	9000	4500	72	24	3000	93
	9540	4770	72	24	4000	93

Driver da ordinare separatamente / Drivers to be ordered separately

AL00179 Output 24Vdc 150W
On/Off

Controller da ordinare separatamente / Controller to be ordered separately

CT00050 Dimmer 1 ch
DALI2-PUSH-0/1..10V

CT00052 Dimmer 1 ch
PUSH/WIRELESS

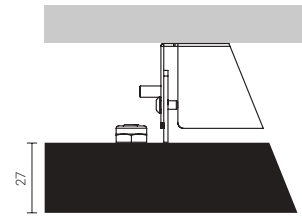

SOLEIL PL

PLAFONE/CEILING/WALL

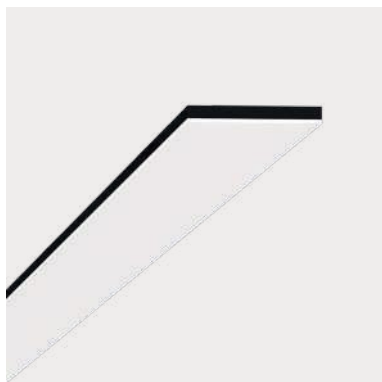

01 Bianco White 02 Nero Black 07 Oro Gold

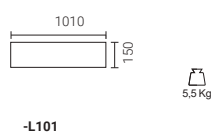

-L101

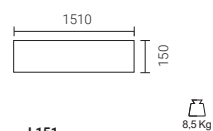

-L151

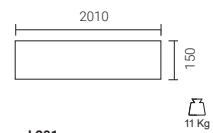

-L201

28 (+/- 1mm)

Reference configurator

Il codice prodotto si compone mettendo in fila, da sinistra a destra, i dati contenuti nelle colonne a partire da "Codice base".

The product code is created by putting in sequence the data starting from "Base code", from left to right.

es: SL-OPLN02L101



Parete / plafone Wall / ceiling

Codice base Base code	Ottica Optic	Fissaggio Fixing	Colour T (K)	Finitura Finish	Chiusura Closing
--------------------------	-----------------	---------------------	-----------------	--------------------	---------------------

Variante da comporre a seconda delle proprie necessità
Variant to compose according to your needs.

SL -	O opale / opal	PL	Z 2700K	01	L101
			C 3000K	02	L151
			N 4000K	07	L201

24Vdc



Caratteristiche illuminotecniche / Lighting specifications

Dimensione Size (mm)	LED Lumen	Product Lumen	Watt	Vdc	Colour T	CRI
1010x150	4800	2400	40	24	2700	93
	5000	2500	40	24	3000	93
	5300	2650	40	24	4000	93
1510x150	7200	3600	60	24	2700	93
	7500	3750	60	24	3000	93
	7950	3975	60	24	4000	93
2010x150	9600	4800	80	24	2700	93
	10000	5000	80	24	3000	93
	10600	5300	80	24	4000	93

Driver da ordinare separatamente / Drivers to be ordered separately

AL00179 Output 24Vdc 150W
On/Off

Controller da ordinare separatamente / Controller to be ordered separately

CT00050 Dimmer 1 ch
DALI2-PUSH-0/1..10V

CT00052 Dimmer 1 ch
PUSH/WIRELESS

SATURN PL

PLAFONE/CEILING/WALL

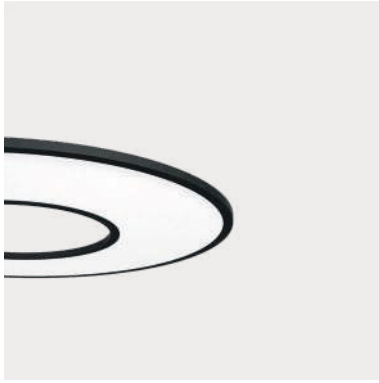

01 Bianco White 02 Nero Black 07 Oro Gold

Codice base Base code **Ottica** Optic **Fissaggio** Fixing **Colour** T (K) **Finitura** Finish **Chiusura** Closing

Versione con foro centrato
Version with centered hole

SAT -	O opale / opal	PL	Z 2700K	01	D070
	P prismatico / prismatic		C 3000K	02	D090
			N 4000K	07	D120

24Vdc

CE IP20

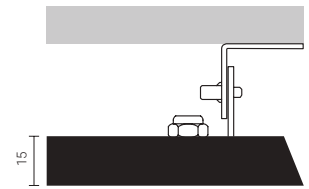

-D070

6,5 Kg



-D090

9 Kg

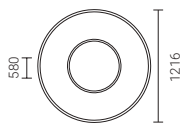

-D120

16 Kg

15 (+/- 1mm)

Caratteristiche illuminotecniche / Lighting specifications

Dimensione Size (mm)	LED Lumen	Product Lumen	Watt	Vdc	Colour T	CRI
Ø707	5280	3168	44	24	2700	93
	5500	3300	44	24	3000	93
	5830	3498	44	24	4000	93
Ø899	6720	4032	56	24	2700	93
	7000	4200	56	24	3000	93
	7420	4452	56	24	4000	93
Ø1216	9120	5472	76	24	2700	93
	9500	5700	76	24	3000	93
	10070	6042	76	24	4000	93

Driver da ordinare separatamente / Drivers to be ordered separately

AL00179 Output 24Vdc 150W
On/Off

Controller da ordinare separatamente / Controller to be ordered separately

CT00050 Dimmer 1 ch
DALI2-PUSH-0/1..10V

CT00052 Dimmer 1 ch
PUSH/WIRELESS

Reference configurator

Il codice prodotto si compone mettendo in fila, da sinistra a destra, i dati contenuti nelle colonne a partire da "Codice base".

The product code is created by putting in sequence the data starting from "Base code", from left to right.

es: SAT-OPLN07D070



SATURN D PL

PLAFONE/CEILING/WALL



01 Bianco White 02 Nero Black 07 Oro Gold



-D070



-D090



-D120



15 (+/- 1mm)

Reference configurator

Il codice prodotto si compone mettendo in fila, da sinistra a destra, i dati contenuti nelle colonne a partire da "Codice base".

The product code is created by putting in sequence the data starting from "Base code", from left to right.

es: DS-OPLN07D070



Codice base Base code	Ottica Optic	Fissaggio Fixing	Colour T (K)	Finitura Finish	Chiusura Closing
--------------------------	-----------------	---------------------	-----------------	--------------------	---------------------

Versione con foro decentrato
Version with off center hole

DS -	O opale / opal	PL	Z 2700K	01	D070
	P prismatico / prismatic		C 3000K	02	D090
			N 4000K	07	D120

24Vdc



Parete / plafone Wall / ceiling

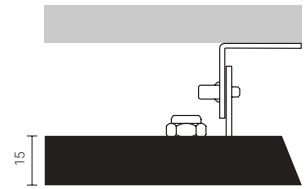

Caratteristiche illuminotecniche / Lighting specifications

Dimensione Size (mm)	LED Lumen	Product Lumen	Watt	Vdc	Colour T	CRI
Ø707	5280	3168	44	24	2700	93
	5500	3300	44	24	3000	93
	5830	3498	44	24	4000	93
Ø899	6720	4032	56	24	2700	93
	7000	4200	56	24	3000	93
	7420	4452	56	24	4000	93
Ø1216	9120	5472	76	24	2700	93
	9500	5700	76	24	3000	93
	10070	6042	76	24	4000	93

Driver da ordinare separatamente / Drivers to be ordered separately

AL00179 Output 24Vdc 150W
On/Off

Controller da ordinare separatamente / Controller to be ordered separately

CT00050 Dimmer 1 ch
DALI2-PUSH-0/1..10V

CT00052 Dimmer 1 ch
PUSH/WIRELESS

INFINITY PL

PLAFONE/CEILING/WALL



01 Bianco White 02 Nero Black 07 Oro Gold

Codice base Ottica Fissaggio Colour Finitura **Chiusura**
Base code Optic Fixing T (K) Finish Closing

Variante da comporre a seconda delle proprie necessità
Variant to compose according to your needs.

IN -	O opale / opal	PL	Z 2700K	01	D100
			C 3000K	02	D150
			N 4000K	07	D200

24Vdc

CE IP20

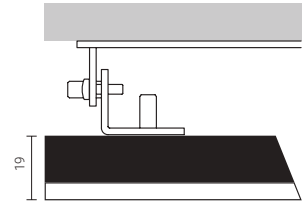

Caratteristiche illuminotecniche / Lighting specifications

Dimensione Size (mm)	LED Lumen	Product Lumen	Watt	Vdc	Colour T	CRI
Ø994	7440	3720	62	24	2700	93
	7770	3875	62	24	3000	93
	8215	4107	62	24	4000	93
Ø1503	11280	5640	94	24	2700	93
	11750	5875	94	24	3000	93
	12455	6227	94	24	4000	93
Ø2013	15120	7560	126	24	2700	93
	15750	7875	126	24	3000	93
	16675	8347	126	24	4000	93



12 Kg

-D100



25 Kg

-D150

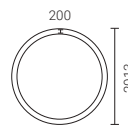

42 Kg

-D200

19 (+/- 1mm)

Driver da ordinare separatamente / Drivers to be ordered separately

AL00179 Output 24Vdc 150W
On/Off

Controller da ordinare separatamente / Controller to be ordered separately

CT00050 Dimmer 1 ch
DALI2-PUSH-0/1..10V

CT00052 Dimmer 1 ch
PUSH/WIRELESS

Reference configurator

Il codice prodotto si compone mettendo in fila, da sinistra a destra, i dati contenuti nelle colonne a partire da "Codice base".

The product code is created by putting in sequence the data starting from "Base code", from left to right.

es: IN-OPLN01D100



ELIPSE PL

PLAFONE/CEILING/WALL



01 Bianco White 02 Nero Black 07 Oro Gold

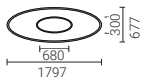

-D176



22 Kg

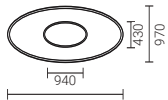

-D259



34 Kg

15 (+/- 1mm)

Parete / plafone Wall / ceiling

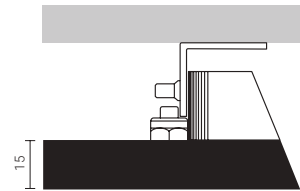

Codice base Base code	Ottica Optic	Fissaggio Fixing	Colour T (K)	Finitura Finish	Chiusura Closing
--------------------------	-----------------	---------------------	-----------------	--------------------	---------------------

Variante da comporre a seconda delle proprie necessità
Variant to compose according to your needs.

EL -	O opale / opal	PL	Z 2700K	01	D176
	P prismatico / prismatic		C 3000K	02	D259
			N 4000K	07	

24Vdc



Caratteristiche illuminotecniche / Lighting specifications

Dimensione Size (mm)	LED Lumen	Product Lumen	Watt	Vdc	Colour T	CRI
1797x677	9600	5760	80	24	2700	93
	10000	6000	80	24	3000	93
	10600	6360	80	24	4000	93
2594x970	13920	8352	116	24	2700	93
	14500	8700	116	24	3000	93
	15370	9222	116	24	4000	93

Driver da ordinare separatamente / Drivers to be ordered separately

AL00179 Output 24Vdc 150W
On/Off

Controller da ordinare separatamente / Controller to be ordered separately

CT00050 Dimmer 1 ch
DALI2-PUSH-0/1..10V

CT00052 Dimmer 1 ch
PUSH/WIRELESS

Reference configurator

Il codice prodotto si compone mettendo in fila, da sinistra a destra, i dati contenuti nelle colonne a partire da "Codice base".

The product code is created by putting in sequence the data starting from "Base code", from left to right.

es: DS-OPLN07D176



GALACTIC PL

PLAFONE/CEILING/WALL



01 Bianco White 02 Nero Black 07 Oro Gold



-L065

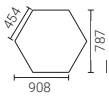

-L097

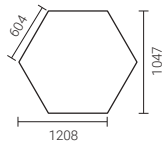

-L120



19 (+/- 1mm)

Reference configurator

Il codice prodotto si compone mettendo in fila, da sinistra a destra, i dati contenuti nelle colonne a partire da "Codice base".

The product code is created by putting in sequence the data starting from "Base code", from left to right.

es: GA-OPLN01L065



Codice base Base code	Ottica Optic	Fissaggio Fixing	Colour T (K)	Finitura Finish	Chiusura Closing
--------------------------	-----------------	---------------------	-----------------	--------------------	---------------------

Variante da comporre a seconda delle proprie necessità
Variant to compose according to your needs.

GA -	O opale / opal	PL	Z 2700K	01	L065
			C 3000K	02	L097
			N 4000K	07	L120

24Vdc

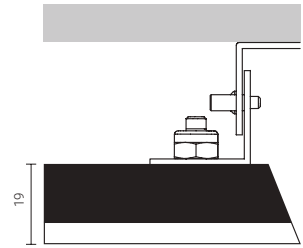

Caratteristiche illuminotecniche / Lighting specifications

Dimensione Size (mm)	LED Lumen	Product Lumen	Watt	Vdc	Colour T	CRI
608x527	4320	2160	36	24	2700	93
	4500	2250	36	24	3000	93
	4770	2385	36	24	4000	93
908x787	6480	3240	54	24	2700	93
	6750	3375	54	24	3000	93
	7155	3577	54	24	4000	93
1208x1047	8640	4320	72	24	2700	93
	9000	4500	72	24	3000	93
	9540	4770	72	24	4000	93

Driver da ordinare separatamente / Drivers to be ordered separately

AL00179 Output 24Vdc 150W
On/Off

Controller da ordinare separatamente / Controller to be ordered separately

CT00050 Dimmer 1 ch
DALI2-PUSH-0/1..10V

CT00052 Dimmer 1 ch
PUSH/WIRELESS

HONEY PL

PLAFONE/CEILING/WALL



01 Bianco White 02 Nero Black 07 Oro Gold



-L108



12,5 Kg

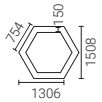

-L150



25,5 Kg

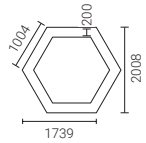

-L201



43,5 Kg

19 (+/- 1mm)

Reference configurator

Il codice prodotto si compone mettendo in fila, da sinistra a destra, i dati contenuti nelle colonne a partire da "Codice base".

The product code is created by putting in sequence the data starting from "Base code", from left to right.

es: GA-OPLN01L065



Codice base Base code	Ottica Optic	Fissaggio Fixing	Colour T (K)	Finitura Finish	Chiusura Closing
--------------------------	-----------------	---------------------	-----------------	--------------------	---------------------

Variante da comporre a seconda delle proprie necessità
Variant to compose according to your needs.

HO -	O opale / opal	PL	Z 2700K	01	L108
			C 3000K	02	L150
			N 4000K	07	L201

24Vdc

CE IP20

Parete / plafone Wall / ceiling

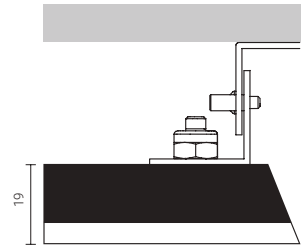

Caratteristiche illuminotecniche / Lighting specifications

Dimensione Size (mm)	LED Lumen	Product Lumen	Watt	Vdc	Colour T	CRI
1008x873	7200	3600	60	24	2700	93
	7500	3750	60	24	3000	93
	7950	3975	60	24	4000	93
1508x1306	10800	5400	90	24	2700	93
	11250	5625	90	24	3000	93
	11925	5962	90	24	4000	93
2008x1739	14400	7200	120	24	2700	93
	15000	7500	120	24	3000	93
	15900	7950	120	24	4000	93

Driver da ordinare separatamente / Drivers to be ordered separately

AL00179 Output 24Vdc 150W
On/Off

Controller da ordinare separatamente / Controller to be ordered separately

CT00050 Dimmer 1 ch
DALI2-PUSH-0/1..10V

CT00052 Dimmer 1 ch
PUSH/WIRELESS

ELETTRA PL

PLAFONE/CEILING/WALL



01 Bianco White 02 Nero Black 07 Oro Gold

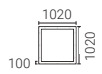

-L101

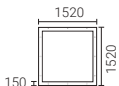

-L151

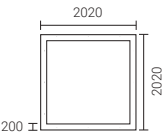

-L202



19 (+/- 1mm)

Reference configurator

Il codice prodotto si compone mettendo in fila, da sinistra a destra, i dati contenuti nelle colonne a partire da "Codice base".

The product code is created by putting in sequence the data starting from "Base code", from left to right.

es: ET-OPLN01L202



Codice base Base code	Ottica Optic	Fissaggio Fixing	Colour T (K)	Finitura Finish	Chiusura Closing
--------------------------	-----------------	---------------------	-----------------	--------------------	---------------------

Variante da comporre a seconda delle proprie necessità
Variant to compose according to your needs.

ET -	O opale / opal	PL	Z 2700K	01	L101
			C 3000K	02	L151
			N 4000K	07	L202

24Vdc

CE IP20

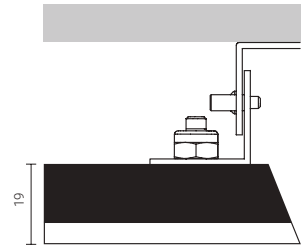

Caratteristiche illuminotecniche / Lighting specifications

Dimensione Size (mm)	LED Lumen	Product Lumen	Watt	Vdc	Colour T	CRI
1020x1020	9600	4800	80	24	2700	93
	10000	5000	80	24	3000	93
	10600	5300	80	24	4000	93
1520x1520	14400	7200	120	24	2700	93
	15000	7500	120	24	3000	93
	15900	7950	120	24	4000	93
2020x2020	19200	9600	160	24	2700	93
	20000	10000	160	24	3000	93
	21200	10600	160	24	4000	93

Driver da ordinare separatamente / Drivers to be ordered separately

AL00184 Output 24Vdc 200W
On/Off

Controller da ordinare separatamente / Controller to be ordered separately

CT00050 Dimmer 1 ch
DALI2-PUSH-0/1..10V

CT00052 Dimmer 1 ch
PUSH/WIRELESS



Elettra PL



03

Superfici sospensione

suspended

Tecnologia che arreda

Technology that furnishes

^{ITA} Non solo lampade, ma elementi d'arredo che si integrano nello spazio con grande personalità ed ecletticità, grazie al design moderno e all'eccellente efficienza e qualità della luce.

Queste Superfici riescono a coniugare forma e funzione, risultato di un design attento che persegue specifiche finalità: funzionalità, affidabilità, manutenibilità, estetica.

Le Superfici sospese esprimono una sensazione di leggerezza, combinate con l'ambiente circostante. La luce artificiale instaura un dialogo continuo con la luce naturale e l'architettura, evidenziando con eleganza oggetti, colori e spazi dell'interior.

^{EN} Not just lighting fittings but furnishing elements that integrate into the space with a great personality and eclecticism, thanks to the modern design and the excellent efficiency and quality of light.

These Surfaces combine form and function: the result of a careful design that pursues specific purposes: functionality, reliability, maintainability, and aesthetics.

Suspended surfaces express a feeling of light combined with the surroundings. Artificial light establishes a continuous dialogue with natural light and architecture, highlighting objects, colours and interiors.





Saturn D SP













03

Superfici

sospensione

suspended



	Products	Pages
	Orbital SP	58
	Pegaso SP	59
	Elegant SQ SP	60
	Cristal SP	61
	Elegant RT SP	62
	Soleil SP	63
	Saturn SP	64
	Saturn D SP	65
	Infinity SP	66
	Elipse SP	67
	Galactic SP	68
	Honey SP	69
	Elettra SP	70

ORBITAL SP

SOSPENSIONE/SUSPENSION



01 Bianco White 02 Nero Black 07 Oro Gold

Codice base Base code	Ottica Optic	Fissaggio Fixing	Colour T (K)	Finitura Finish	Chiusura Closing
--------------------------	-----------------	---------------------	-----------------	--------------------	---------------------

Variante da comporre a seconda delle proprie necessità
Variant to compose according to your needs.

OR -	O opale / opal	SP	Z 2700K	01	D070
	P prismatico / prismatic		C 3000K	02	D090
			N 4000K	07	D120

24Vdc

CE IP20

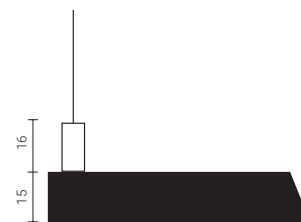

Caratteristiche illuminotecniche / Lighting specifications

Dimensione Size (mm)	LED Lumen	Product Lumen	Watt	Vdc	Colour T	CRI
Ø707	5280	3168	44	24	2700	93
	5500	3300	44	24	3000	93
	5830	3498	44	24	4000	93
Ø899	6720	4032	56	24	2700	93
	7000	4200	56	24	3000	93
	7420	4452	56	24	4000	93
Ø1216	9120	5472	76	24	2700	93
	9500	5700	76	24	3000	93
	10070	6042	76	24	4000	93

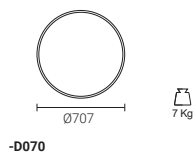

-D070

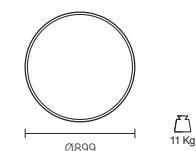

-D090

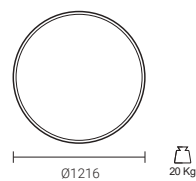

-D120

15 (+/- 1mm)

Driver da ordinare separatamente / Drivers to be ordered separately

AL00179 Output 24Vdc 150W
On/Off

Controller da ordinare separatamente / Controller to be ordered separately

CT00050 Dimmer 1 ch
DALI2-PUSH-0/1..10V

CT00052 Dimmer 1 ch
PUSH/WIRELESS

Reference configurator

Il codice prodotto si compone mettendo in fila, da sinistra a destra, i dati contenuti nelle colonne a partire da "Codice base".

The product code is created by putting in sequence the data starting from "Base code", from left to right.

es: OR-OSPN07D120



Accessori / accessories

 **Rosone quadrato / Square canopy**
AC00362_00001 Bianco / White
AC00362 Nero / Black
AC00362_00004 Oro / Gold

 **Rosone tondo / Round canopy**
AC00385 Bianco / White
AC00385_00002 Nero / Black
AC00385_00004 Oro / Gold

 **Rosone copricavi / Cable cover canopy**
AC00262 Bianco / White
AC00320 Nero / Black
Ø83 mm

PEGASO SP

SOSPENSIONE/SUSPENSION

Sospensione Suspended



01 Bianco White 02 Nero Black 07 Oro Gold

Codice base Base code **Ottica** Optic **Fissaggio** Fixing **Colour** T (K) **Finitura** Finish **Chiusura** Closing

Variante da comporre a seconda delle proprie necessità
Variant to compose according to your needs.

PG - **O** opale / opal **SP** **Z** 2700K **01** **D060**
C 3000K **02** **D090**
N 4000K **07** **D120**

24Vdc

CE IP20

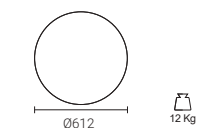
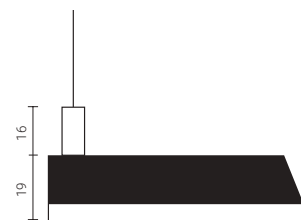

-D060

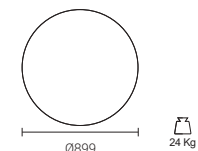

-D090

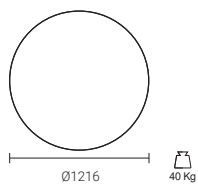

-D120

19 (+/- 1mm)

Caratteristiche illuminotecniche / Lighting specifications

Dimensione Size (mm)	LED Lumen	Product Lumen	Watt	Vdc	Colour T	CRI
Ø612	4320	2160	38	24	2700	93
	4500	2250	38	24	3000	93
	4770	2385	38	24	4000	93
Ø899	6720	3360	56	24	2700	93
	7000	3500	56	24	3000	93
	7420	3710	56	24	4000	93
Ø1216	9120	4560	76	24	2700	93
	9500	4750	76	24	3000	93
	10070	5035	76	24	4000	93

Driver da ordinare separatamente / Drivers to be ordered separately

AL00179 Output 24Vdc 150W
On/Off

Controller da ordinare separatamente / Controller to be ordered separately

CT00050 Dimmer 1 ch
DALI2-PUSH-0/1..10V

CT00052 Dimmer 1 ch
PUSH/WIRELESS

Reference configurator

Il codice prodotto si compone mettendo in fila, da sinistra a destra, i dati contenuti nelle colonne a partire da "Codice base".

The product code is created by putting in sequence the data starting from "Base code", from left to right.

es: PG-OSPN07D120



Accessori / accessories

Rosone quadrato / Square canopy
AC00362_00001 Bianco / White
AC00362 Nero / Black
AC00362_00004 Oro / Gold

Rosone tondo / Round canopy
AC00385 Bianco / White
AC00385_00002 Nero / Black
AC00385_00004 Oro / Gold

Rosone copricavi / Cable cover canopy
AC00262 Bianco / White
AC00320 Nero / Black
Ø83 mm

ELEGANT SQ SP

SOSPENSIONE/SUSPENSION



01 Bianco White 02 Nero Black 07 Oro Gold

Codice base Base code	Ottica Optic	Fissaggio Fixing	Colour T (K)	Finitura Finish	Chiusura Closing
--------------------------	-----------------	---------------------	-----------------	--------------------	---------------------

Variante da comporre a seconda delle proprie necessità
Variant to compose according to your needs.

ELG -	O opale / opal	SP	Z 2700K	01	L066
	P prismatico / prismatic		C 3000K	02	L091
			N 4000K	07	L111

24Vdc

CE IP20

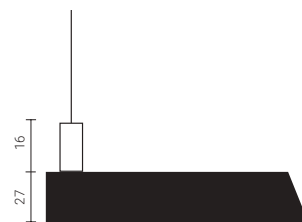

Caratteristiche illuminotecniche / Lighting specifications

Dimensione Size (mm)	LED Lumen	Product Lumen	Watt	Vdc	Colour T	CRI
610x610	5760	3456	48	24	2700	93
	6000	3600	48	24	3000	93
	6360	3816	48	24	4000	93
910x910	8640	5184	72	24	2700	93
	9000	5400	72	24	3000	93
	9540	5724	72	24	4000	93
1110x1110	10560	6336	80	24	2700	93
	11000	6600	80	24	3000	93
	11660	6996	80	24	4000	93

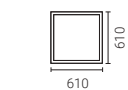

6 Kg

-L066

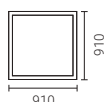

12 Kg

-L091

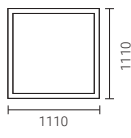

18 Kg

-L111

27 (+/- 1mm)

Driver da ordinare separatamente / Drivers to be ordered separately

AL00179 Output 24Vdc 150W
On/Off

Controller da ordinare separatamente / Controller to be ordered separately

CT00050 Dimmer 1 ch
DALI2-PUSH-0/1..10V

CT00052 Dimmer 1 ch
PUSH/WIRELESS

Reference configurator

Il codice prodotto si compone mettendo in fila, da sinistra a destra, i dati contenuti nelle colonne a partire da "Codice base".

The product code is created by putting in sequence the data starting from "Base code", from left to right.

es: ELG-OCRN07L111



Accessori / accessories



Rosone quadrato / Square canopy
AC00362_00001 Bianco / White
AC00362 Nero / Black
AC00362_00004 Oro / Gold



Rosone tondo / Round canopy
AC00385 Bianco / White
AC00385_00002 Nero / Black
AC00385_00004 Oro / Gold



Rosone copricavi / Cable cover canopy
AC00262 Bianco / White
AC00320 Nero / Black
Ø83 mm

CRISTAL SP

SOSPENSIONE/SUSPENSION

Sospensione Suspended



01 Bianco White 02 Nero Black 07 Oro Gold

Codice base Base code **Ottica** Optic **Fissaggio** Fixing **Colour** T (K) **Finitura** Finish **Chiusura** Closing

Variante da comporre a seconda delle proprie necessità.
Variant to compose according to your needs.

CR - **O** opale / opal **SP** **Z** 2700K **01** **L066**
C 3000K **02** **L099**
N 4000K **07** **L121**

24Vdc

CE IP20

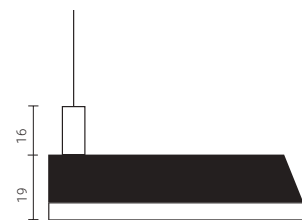

Caratteristiche illuminotecniche / Lighting specifications

Dimensione Size (mm)	LED Lumen	Product Lumen	Watt	Vdc	Colour T	CRI
620x620	5760	2880	48	24	2700	93
	6000	3000	48	24	3000	93
	6360	3180	48	24	4000	93
920x920	8640	4320	72	24	2700	93
	9000	4500	72	24	3000	93
	9540	4770	72	24	4000	93
1220x1220	11520	5760	96	24	2700	93
	12000	6000	96	24	3000	93
	12720	6360	96	24	4000	93

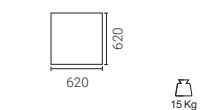

-L066

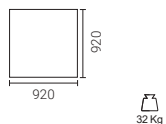

-L099

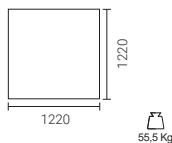

-L121

19 (+/- 1mm)

Driver da ordinare separatamente / Drivers to be ordered separately

AL00179 Output 24Vdc 150W
On/Off

Controller da ordinare separatamente / Controller to be ordered separately

CT00050 Dimmer 1 ch
DALI2-PUSH-0/1..10V

CT00052 Dimmer 1 ch
PUSH/WIRELESS

Reference configurator

Il codice prodotto si compone mettendo in fila, da sinistra a destra, i dati contenuti nelle colonne a partire da "Codice base".

The product code is created by putting in sequence the data starting from "Base code", from left to right.

es: CR-OCRN02L099



Accessori / accessories

Rosone quadrato / Square canopy
AC00362_00001 Bianco / White
AC00362 Nero / Black
AC00362_00004 Oro / Gold

Rosone tondo / Round canopy
AC00385 Bianco / White
AC00385_00002 Nero / Black
AC00385_00004 Oro / Gold

Rosone copricavi / Cable cover canopy
AC00262 Bianco / White
AC00320 Nero / Black
Ø83 mm

ELEGANT RT SP

SOSPENSIONE/SUSPENSION



01 Bianco White 02 Nero Black 07 Oro Gold

Codice base Base code	Ottica Optic	Fissaggio Fixing	Colour T (K)	Finitura Finish	Chiusura Closing
--------------------------	-----------------	---------------------	-----------------	--------------------	---------------------

Variante da comporre a seconda delle proprie necessità
Variant to compose according to your needs.

ELG -	O opale / opal	SP	Z 2700K	01	L126
	P prismatico / prismatic		C 3000K	02	L156
			N 4000K	07	L186

24Vdc

CE IP20

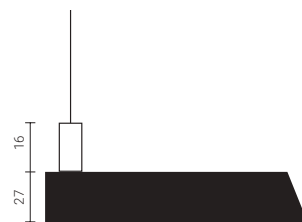

Caratteristiche illuminotecniche / Lighting specifications

Dimensione Size (mm)	LED Lumen	Product Lumen	Watt	Vdc	Colour T	CRI
1210x610	5760	3456	48	24	2700	93
	6000	3600	48	24	3000	93
	6360	3816	48	24	4000	93
1510x910	7200	4320	60	24	2700	93
	7500	4500	60	24	3000	93
	7950	4770	60	24	4000	93
1810x610	8640	4320	72	24	2700	93
	9000	4500	72	24	3000	93
	9540	4770	72	24	4000	93



11 Kg

-L126

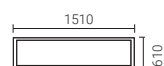

14 Kg

-L156

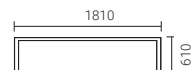

16 Kg

-L186

27 (+/- 1mm)

Driver da ordinare separatamente / Drivers to be ordered separately

AL00179 Output 24Vdc 150W
On/Off

Controller da ordinare separatamente / Controller to be ordered separately

CT00050 Dimmer 1 ch
DALI2-PUSH-0/1..10V

CT00052 Dimmer 1 ch
PUSH/WIRELESS

Reference configurator

Il codice prodotto si compone mettendo in fila, da sinistra a destra, i dati contenuti nelle colonne a partire da "Codice base".

The product code is created by putting in sequence the data starting from "Base code", from left to right.

es: ELG-OSPN07L126



Accessori / accessories



Rosone quadrato / Square canopy
AC00362_00001 Bianco / White
AC00362 Nero / Black
AC00362_00004 Oro / Gold



Rosone tondo / Round canopy
AC00385 Bianco / White
AC00385_00002 Nero / Black
AC00385_00004 Oro / Gold



Rosone copricavi / Cable cover canopy
AC00262 Bianco / White
AC00320 Nero / Black
Ø83 mm

SOLEIL SP

SOSPENSIONE/SUSPENSION

Sospensione Suspended



01 Bianco White 02 Nero Black 07 Oro Gold

Codice base Base code **Ottica** Optic **Fissaggio** Fixing **Colour** T (K) **Finitura** Finish **Chiusura** Closing

Variante da comporre a seconda delle proprie necessità
Variant to compose according to your needs.

SL - **O** opale / opal **SP** **Z** 2700K **01** **L101**
C 3000K **02** **L151**
N 4000K **07** **L201**

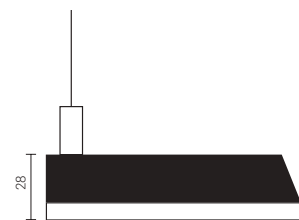

24Vdc

CE IP20

Caratteristiche illuminotecniche / Lighting specifications

Dimensione Size (mm)	LED Lumen	Product Lumen	Watt	Vdc	Colour T	CRI
1010x150	4800	2400	40	24	2700	93
	5000	2500	40	24	3000	93
	5300	2650	40	24	4000	93
1510x150	7200	3600	60	24	2700	93
	7500	3750	60	24	3000	93
	7950	3975	60	24	4000	93
2010x150	9600	4800	80	24	2700	93
	10000	5000	80	24	3000	93
	10600	5300	80	24	4000	93



5,5 Kg

-L101



8,5 Kg

-L151



11 Kg

-L201

28 (+/- 1mm)

Driver da ordinare separatamente / Drivers to be ordered separately

AL00179 Output 24Vdc 150W
On/Off

Controller da ordinare separatamente / Controller to be ordered separately

CT00050 Dimmer 1 ch
DALI2-PUSH-0/1..10V

CT00052 Dimmer 1 ch
PUSH/WIRELESS

Reference configurator

Il codice prodotto si compone mettendo in fila, da sinistra a destra, i dati contenuti nelle colonne a partire da "Codice base".

The product code is created by putting in sequence the data starting from "Base code", from left to right.

es: SL-OSPN02L101



Accessori / accessories



Rosone quadrato / Square canopy
AC00362_00001 Bianco / White
AC00362 Nero / Black
AC00362_00004 Oro / Gold



Rosone tondo / Round canopy
AC00385 Bianco / White
AC00385_00002 Nero / Black
AC00385_00004 Oro / Gold



Rosone copricavi / Cable cover canopy
AC00262 Bianco / White
AC00320 Nero / Black
Ø83 mm

SATURN CENTRATO SP

SOSPENSIONE/SUSPENSION



01 Bianco White 02 Nero Black 07 Oro Gold

Codice base Base code	Ottica Optic	Fissaggio Fixing	Colour T (K)	Finitura Finish	Chiusura Closing
--------------------------	-----------------	---------------------	-----------------	--------------------	---------------------

Variante da comporre a seconda delle proprie necessità
Variant to compose according to your needs.

SAT -	O opale / opal	SP	Z 2700K	01	D070
	P prismatico / prismatic		C 3000K	02	D090
			N 4000K	07	D120

24Vdc

CE IP20

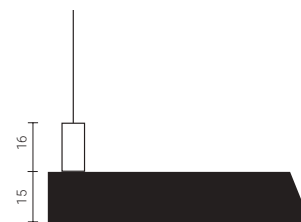

6,5 Kg

-D070



9 Kg

-D090

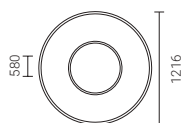

16 Kg

-D120

15 (+/- 1mm)

Caratteristiche illuminotecniche / Lighting specifications

Dimensione Size (mm)	LED Lumen	Product Lumen	Watt	Vdc	Colour T	CRI
Ø707	5280	3168	44	24	2700	93
	5500	3300	44	24	3000	93
	5830	3498	44	24	4000	93
Ø899	6720	4032	56	24	2700	93
	7000	4200	56	24	3000	93
	7420	4452	56	24	4000	93
Ø1216	9120	5472	76	24	2700	93
	9500	5700	76	24	3000	93
	10070	6042	76	24	4000	93

Driver da ordinare separatamente / Drivers to be ordered separately

AL00179 Output 24Vdc 150W
On/Off

Controller da ordinare separatamente / Controller to be ordered separately

CT00050 Dimmer 1 ch
DALI2-PUSH-0/1..10V

CT00052 Dimmer 1 ch
PUSH/WIRELESS

Reference configurator

Il codice prodotto si compone mettendo in fila, da sinistra a destra, i dati contenuti nelle colonne a partire da "Codice base".

The product code is created by putting in sequence the data starting from "Base code", from left to right.

es: SAT-OPLN07D070



Accessori / accessories



Rosone quadrato / Square canopy
AC00362_00001 Bianco / White
AC00362 Nero / Black
AC00362_00004 Oro / Gold



Rosone tondo / Round canopy
AC00385 Bianco / White
AC00385_00002 Nero / Black
AC00385_00004 Oro / Gold



Rosone copricavi / Cable cover canopy
AC00262 Bianco / White
AC00320 Nero / Black
Ø83 mm

SATURN DECENTRATO SP

SOSPENSIONE/SUSPENSION

Sospensione Suspended

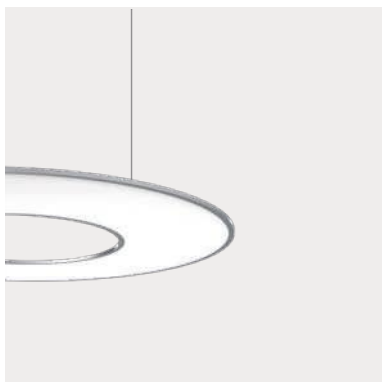

01 Bianco White 02 Nero Black 07 Oro Gold

Codice base Base code **Ottica** Optic **Fissaggio** Fixing **Colour** T (K) **Finitura** Finish **Chiusura** Closing

Variante da comporre a seconda delle proprie necessità
Variant to compose according to your needs.

DS -	O opale / opal	SP	Z 2700K	01	D070
	P prismatico / prismatic		C 3000K	02	D090
			N 4000K	07	D120

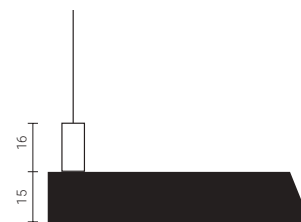

24Vdc

CE IP20

Caratteristiche illuminotecniche / Lighting specifications



-D070

6.5 Kg



-D090

9 Kg



-D120

16 Kg

15 (+/- 1mm)

Dimensione Size (mm)	LED Lumen	Product Lumen	Watt	Vdc	Colour T	CRI
Ø707	5280	3168	44	24	2700	93
	5500	3300	44	24	3000	93
	5830	3498	44	24	4000	93
Ø899	6720	4032	56	24	2700	93
	7000	4200	56	24	3000	93
	7420	4452	56	24	4000	93
Ø1216	9120	5472	76	24	2700	93
	9500	5700	76	24	3000	93
	10070	6042	76	24	4000	93

Driver da ordinare separatamente / Drivers to be ordered separately

AL00179 Output 24Vdc 150W
On/Off

Controller da ordinare separatamente / Controller to be ordered separately

CT00050 Dimmer 1 ch
DALI2-PUSH-0/1..10V

CT00052 Dimmer 1 ch
PUSH/WIRELESS

Reference configurator

Il codice prodotto si compone mettendo in fila, da sinistra a destra, i dati contenuti nelle colonne a partire da "Codice base".

The product code is created by putting in sequence the data starting from "Base code", from left to right.

es: DS-OPLN07D070



Accessori / accessories



Rosone quadrato / Square canopy
AC00362_00001 Bianco / White
AC00362 Nero / Black
AC00362_00004 Oro / Gold



Rosone tondo / Round canopy
AC00385 Bianco / White
AC00385_00002 Nero / Black
AC00385_00004 Oro / Gold



Rosone copricavi / Cable cover canopy
AC00262 Bianco / White
AC00320 Nero / Black
Ø83 mm

INFINITY SP

SOSPENSIONE/SUSPENSION



01 Bianco White 02 Nero Black 07 Oro Gold

Codice base Ottica Fissaggio Colour Finitura **Chiusura**
Base code Optic Fixing T (K) Finish Closing

Variante da comporre a seconda delle proprie necessità
Variant to compose according to your needs.

IN -	O opale / opal	SP	Z 2700K	01	D100
			C 3000K	02	D150
			N 4000K	07	D200

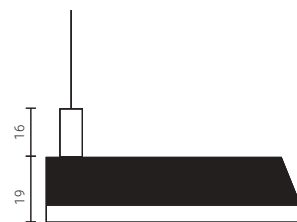

24Vdc

CE IP20

Caratteristiche illuminotecniche / Lighting specifications

Dimensione Size (mm)	LED Lumen	Product Lumen	Watt	Vdc	Colour T	CRI
Ø994	7440	3720	62	24	2700	93
	7770	3875	62	24	3000	93
	8215	4107	62	24	4000	93
Ø1503	11280	5640	94	24	2700	93
	11750	5875	94	24	3000	93
	12455	6227	94	24	4000	93
Ø2013	15120	7560	126	24	2700	93
	15750	7875	126	24	3000	93
	16675	8347	126	24	4000	93



12 Kg

-D100



25 Kg

-D150

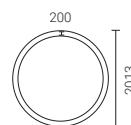

42 Kg

-D200

19 (+/- 1mm)

Driver da ordinare separatamente / Drivers to be ordered separately

AL00179 Output 24Vdc 150W
On/Off

Controller da ordinare separatamente / Controller to be ordered separately

CT00050 Dimmer 1 ch
DALI2-PUSH-0/1..10V

CT00052 Dimmer 1 ch
PUSH/WIRELESS

Reference configurator

Il codice prodotto si compone mettendo in fila, da sinistra a destra, i dati contenuti nelle colonne a partire da "Codice base".

The product code is created by putting in sequence the data starting from "Base code", from left to right.

es: IN-OSPN01D100



Accessori / accessories



Rosone quadrato / Square canopy
AC00362_00001 Bianco / White
AC00362 Nero / Black
AC00362_00004 Oro / Gold



Rosone tondo / Round canopy
AC00385 Bianco / White
AC00385_00002 Nero / Black
AC00385_00004 Oro / Gold



Rosone copricavi / Cable cover canopy
AC00262 Bianco / White
AC00320 Nero / Black
Ø83 mm

ELIPSE SP

SOSPENSIONE/SUSPENSION

Sospensione Suspended



01 Bianco White 02 Nero Black 07 Oro Gold

Codice base Base code **Ottica** Optic **Fissaggio** Fixing **Colour** T (K) **Finitura** Finish **Chiusura** Closing

Variante da comporre a seconda delle proprie necessità
Variant to compose according to your needs.

EL -	O opale / opal	SP	Z 2700K	01	D176
	P prismatico / prismatic		C 3000K	02	D259
			N 4000K	07	

24Vdc

CE IP20

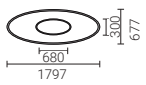
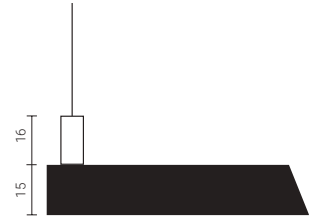

22 Kg

-D176

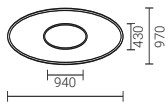

34 Kg

-D259

15 (+/- 1mm)

Caratteristiche illuminotecniche / Lighting specifications

Dimensione Size (mm)	LED Lumen	Product Lumen	Watt	Vdc	Colour T	CRI
1797x677	9600	5760	80	24	2700	93
	10000	6000	80	24	3000	93
	10600	6360	80	24	4000	93
2594x970	13920	8352	116	24	2700	93
	14500	8700	116	24	3000	93
	15370	9222	116	24	4000	93

Driver da ordinare separatamente / Drivers to be ordered separately

AL00179 Output 24Vdc 150W
On/Off

Controller da ordinare separatamente / Controller to be ordered separately

CT00050 Dimmer 1 ch
DALI2-PUSH-0/1..10V

CT00052 Dimmer 1 ch
PUSH/WIRELESS

Reference configurator

Il codice prodotto si compone mettendo in fila, da sinistra a destra, i dati contenuti nelle colonne a partire da "Codice base".

The product code is created by putting in sequence the data starting from "Base code", from left to right.

es: DS-OSPN07D070



Accessori / accessories



Rosone quadrato / Square canopy
AC00362_00001 Bianco / White
AC00362 Nero / Black
AC00362_00004 Oro / Gold



Rosone tondo / Round canopy
AC00385 Bianco / White
AC00385_00002 Nero / Black
AC00385_00004 Oro / Gold



Rosone copricavi / Cable cover canopy
AC00262 Bianco / White
AC00320 Nero / Black
Ø83 mm

GALACTIC SP

SOSPENSIONE/SUSPENSION



01 Bianco White 02 Nero Black 07 Oro Gold

Codice base Base code **Ottica** Optic **Fissaggio** Fixing **Colour** T (K) **Finitura** Finish **Chiusura** Closing

Variante da comporre a seconda delle proprie necessità
Variant to compose according to your needs.

GA - **O** opale / opal **SP** **Z** 2700K **01** **L065**
C 3000K **02** **L097**
N 4000K **07** **L120**

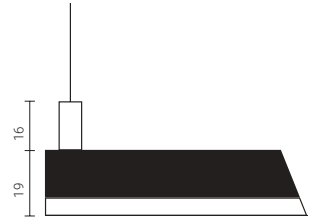

24Vdc

CE IP20

Caratteristiche illuminotecniche / Lighting specifications

Dimensione Size (mm)	LED Lumen	Product Lumen	Watt	Vdc	Colour T	CRI
608x527	7200	3600	36	24	2700	93
	7500	3750	36	24	3000	93
	7950	3975	36	24	4000	93
908x787	10800	5400	54	24	2700	93
	11250	5625	54	24	3000	93
	11925	5962	54	24	4000	93
1208x1047	14400	7200	72	24	2700	93
	15000	7500	72	24	3000	93
	15900	7950	72	24	4000	93



-L065

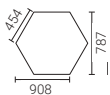

-L097

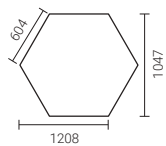

-L120



19 (+/- 1mm)

Driver da ordinare separatamente / Drivers to be ordered separately

07145 Output 24Vdc 150W
On/Off

Controller da ordinare separatamente / Controller to be ordered separately

CT0050 Dimmer 1 ch
DALI2-PUSH-0/1..10V

CT0052 Dimmer 1 ch
PUSH/WIRELESS

Reference configurator

Il codice prodotto si compone mettendo in fila, da sinistra a destra, i dati contenuti nelle colonne a partire da "Codice base".

The product code is created by putting in sequence the data starting from "Base code", from left to right.

es: GA-OSPN01L065



Accessori / accessories



Rosone quadrato / Square canopy
AC00362_00001 Bianco / White
AC00362 Nero / Black
AC00362_00004 Oro / Gold



Rosone tondo / Round canopy
AC00385 Bianco / White
AC00385_00002 Nero / Black
AC00385_00004 Oro / Gold



Rosone copricavi / Cable cover canopy
AC00262 Bianco / White
AC00320 Nero / Black
Ø83 mm

HONEY SP

SOSPENSIONE/SUSPENSION

Sospensione Suspended



01 Bianco White 02 Nero Black 07 Oro Gold

Codice base Ottica Fissaggio Colour Finitura Chiusura
Base code Optic Fixing T (K) Finish Closing

Variante da comporre a seconda delle proprie necessità
Variant to compose according to your needs.

HO -	O opale / opal	SP	Z 2700K	01	L108
			C 3000K	02	L150
			N 4000K	07	L201

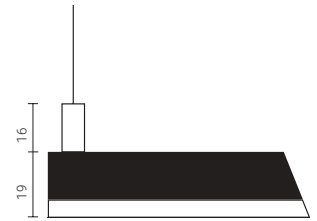

24Vdc

CE IP20

Caratteristiche illuminotecniche / Lighting specifications

Dimensione Size (mm)	LED Lumen	Product Lumen	Watt	Vdc	Colour T	CRI
1008x873	7200	3600	60	24	2700	93
	7500	3750	60	24	3000	93
	7950	3975	60	24	4000	93
1508x1306	10800	5400	90	24	2700	93
	11250	5625	90	24	3000	93
	11925	5962	90	24	4000	93
2008x1739	14400	7200	120	24	2700	93
	15000	7500	120	24	3000	93
	15900	7950	120	24	4000	93



-L108

12,5 Kg

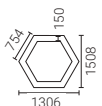

-L150

25,5 Kg

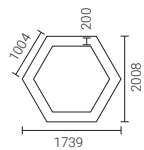

-L201

43,5 Kg

19 (+/- 1mm)

Driver da ordinare separatamente / Drivers to be ordered separately

07145 Output 24Vdc 150W
On/Off

Controller da ordinare separatamente / Controller to be ordered separately

CT0050 Dimmer 1 ch
DALI2-PUSH-0/1..10V

CT0052 Dimmer 1 ch
PUSH/WIRELESS

Reference configurator

Il codice prodotto si compone mettendo in fila, da sinistra a destra, i dati contenuti nelle colonne a partire da "Codice base".

The product code is created by putting in sequence the data starting from "Base code", from left to right.

es: HO-OSPZ07L201



Accessori / accessories



Rosone quadrato / Square canopy
AC00362_00001 Bianco / White
AC00362 Nero / Black
AC00362_00004 Oro / Gold



Rosone tondo / Round canopy
AC00385 Bianco / White
AC00385_00002 Nero / Black
AC00385_00004 Oro / Gold



Rosone copricavi / Cable cover canopy
AC00262 Bianco / White
AC00320 Nero / Black
Ø83 mm

ELETTRA SP

SOSPENSIONE/SUSPENSION



01 Bianco White 02 Nero Black 07 Oro Gold

Codice base Base code **Ottica** Optic **Fissaggio** Fixing **Colour** T (K) **Finitura** Finish **Chiusura** Closing

Variante da comporre a seconda delle proprie necessità
Variant to compose according to your needs.

ET - **O** opale / opal **SP** **Z** 2700K **01** **L101**
C 3000K **02** **L151**
N 4000K **07** **L202**

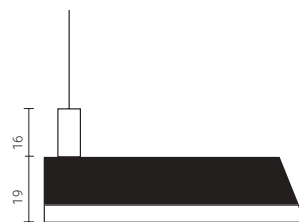

24Vdc

CE IP20

Caratteristiche illuminotecniche / Lighting specifications

Dimensione Size (mm)	LED Lumen	Product Lumen	Watt	Vdc	Colour T	CRI
1020x1020	9600	4800	80	24	2700	93
	10000	5000	80	24	3000	93
	10600	5300	80	24	4000	93
1520x1520	14400	7200	120	24	2700	93
	15000	7500	120	24	3000	93
	15900	7950	120	24	4000	93
2020x2020	19200	9600	160	24	2700	93
	20000	10000	160	24	3000	93
	21200	10600	160	24	4000	93



-L101



17 Kg

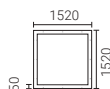

-L151



35 Kg

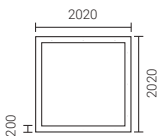

-L202



59 Kg

19 (+/- 1mm)

Driver da ordinare separatamente / Drivers to be ordered separately

AL00184 Output 24Vdc 200W
On/Off

Controller da ordinare separatamente / Controller to be ordered separately

CT00050 Dimmer 1 ch
DALI2-PUSH-0/1..10V

CT00052 Dimmer 1 ch
PUSH/WIRELESS

Reference configurator

Il codice prodotto si compone mettendo in fila, da sinistra a destra, i dati contenuti nelle colonne a partire da "Codice base".

The product code is created by putting in sequence the data starting from "Base code", from left to right.

es: ET-OSPN01L202



Accessori / accessories



Rosone quadrato / Square canopy
AC00362_00001 Bianco / White
AC00362 Nero / Black
AC00362_00004 Oro / Gold



Rosone tondo / Round canopy
AC00385 Bianco / White
AC00385_00002 Nero / Black
AC00385_00004 Oro / Gold



Rosone copricavi / Cable cover canopy
AC00262 Bianco / White
AC00320 Nero / Black
Ø83 mm



Elettra SP

**04**

Superfici

super custom

Ispirati dai tuoi sogni

Inspired by your dreams

^{ITA} I pannelli SuperCustom sono un modo innovativo per illuminare e decorare con la luce. Possono essere installati a parete o a soffitto, oppure diventare parte integrante degli arredi. Per questo, la loro applicazione ideale è all'interno di negozi, hospitality e ho.re.ca e installazioni artistiche o pubblicitarie.

Eleganza e semplicità rendono il retroilluminato un prodotto senza tempo, protagonista della scena e indimenticabile. La linea definita e sottile del suo profilo, con margini meticolosamente rifiniti, creano un prodotto compatto ed essenziale, adatto anche ai progetti più particolari.

^{EN} SuperCustom Panels are an innovative way to illuminate and decorate with light. They can be installed on the wall or ceiling or become an integral part of the furnishings. For this reason, their ideal application is in shops, hospitality and ho.re.ca and artistic or advertising installations.

Elegance and simplicity make the backlit a timeless product, the protagonist of the scene and unforgettable. The defined and thin line of its profile, with meticulously finished edges, creates a compact and essential product suitable for even the most particular projects.





Easy super custom



backlight
LED warm white

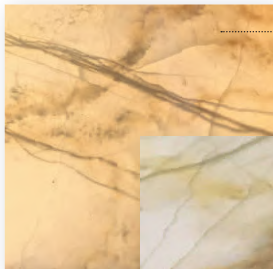

backlight
LED neutral white

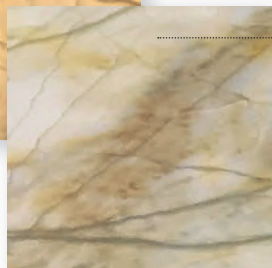



Brick

Pannello led ideato per il progetto "tuttaluce", senza bordi perimetrali e completamente customizzabile

LED panel designed for the project "all light", without perimeter edges and completely customizable

Visual

pannello LED ideale per la retro-illuminazione, con un sistema telo intercambiabile

LED panel ideal for backlighting, with interchangeable fabric

Uniform

pannello LED ideale per l'integrazione in mobili, mensole e scaffali

LED panel perfect for integration into furniture and shelves

Easy

Pannello led perfetto per la retroilluminazione di grafiche, marmi, onici e ogni materiale che faccia trasparire luce

LED panel perfect for backlighting graphics, marbles, onyx and any material that makes light shine through

^{ITA} **Tutte le versioni Super Custom garantiscono un'incredibile qualità della luce e un'omogeneità senza precedenti.**

La luce è in grado di propagarsi in maniera naturale ed uniforme esaltando le architetture e gli arredi.

^{EN} All Super custom versions guarantee incredible light quality and unprecedented homogeneity. The light can spread in a natural and uniform way, enhancing the architecture and furnishings.





04

Superfici super custom

BRICK

Quando l'architettura si fa luce

When architecture becomes light

^{ITA} Brick libera la luce dai confini dettati dai profili. La purezza delle linee nette, senza cornice in alluminio, crea il perfetto connubio architettonico e funzionale.

Il pannello Brick è ideale per grandi spazi espositivi come: negozi, ristoranti, espositori, installazioni architettoniche o superfici d'appoggio luminose.

Prodotto custom da realizzare secondo specifiche.

^{EN} Brick frees light from boundaries set by frames. Only pure and clean lines, without an aluminum frame, create the perfect fusion between architecture and function. The Brick panels are ideal for large show rooms: shops, restaurants, display-cases, architectural installations or any lit surface.

Custom product to be realized according to specifications.



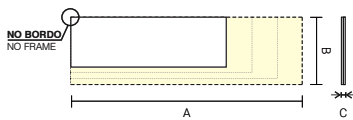
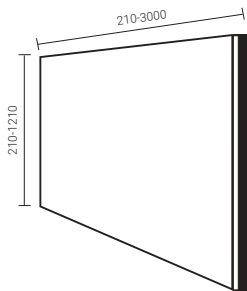
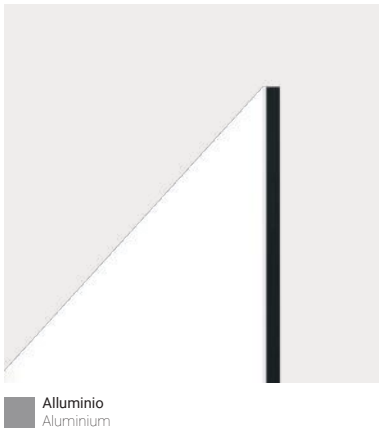

A: Min. 210mm / Max 3000mm
 B: Min. 210mm / Max 1210mm
 C: 19mm / 20mm / 29mm

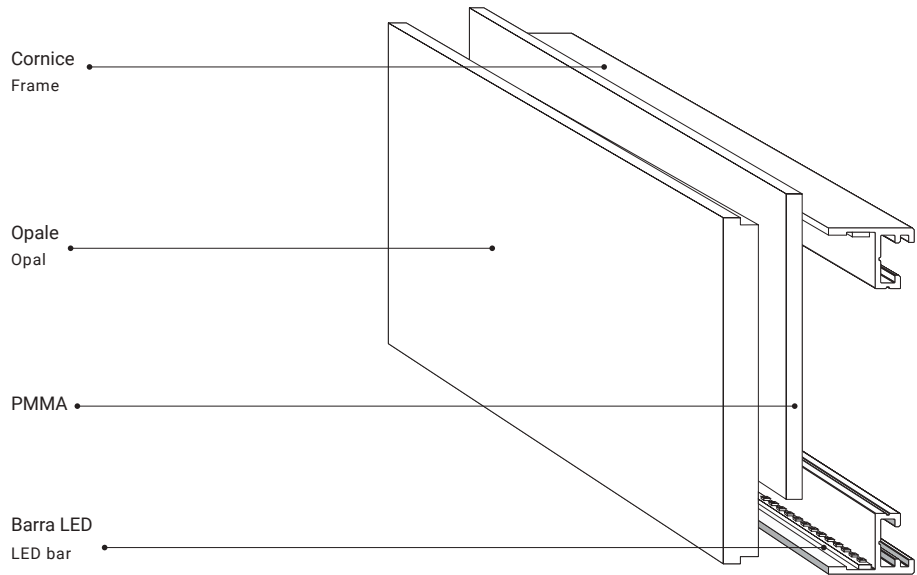

Brick installazione a parete (a sinistra)
 Brick wall installation (on the left)

Brick custom - Silversea, Silver Muse
 (a destra / on the right)



**04**

Superfici

super custom**VISUAL****Un'immagine vale
più di mille parole**

A picture is worth a thousand words

^{ITA} Indicato per la retro-illuminazione; il sistema a telo intercambiabile permette una semplice sostituzione delle grafiche. La separazione fra retroilluminazione e diffusore e l'estrema leggerezza di quest'ultimo permettono inoltre la realizzazione di grandi superfici luminose.

Prodotto custom da realizzare secondo specifiche.

^{EN} Suitable for back-lighting; the interchangeable fabric system allows an easy replacement of the graphics. The gap between the backlight and the diffuser and the extreme lightness of the latter also allows the creation of large light surfaces.

Custom product to be realized according to specifications.



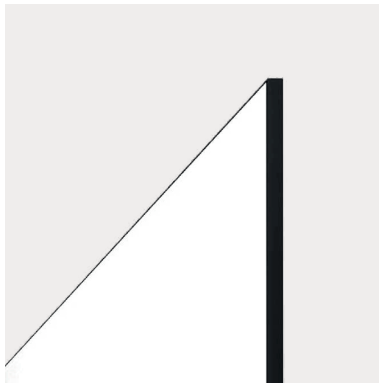

Alluminio
Aluminium

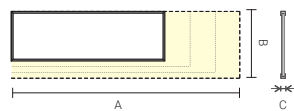
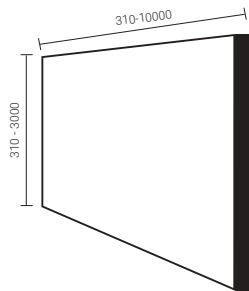

A: Min. 310mm / Max 3010mm
B: Min. 310mm / Max 10000mm
C: 63mm

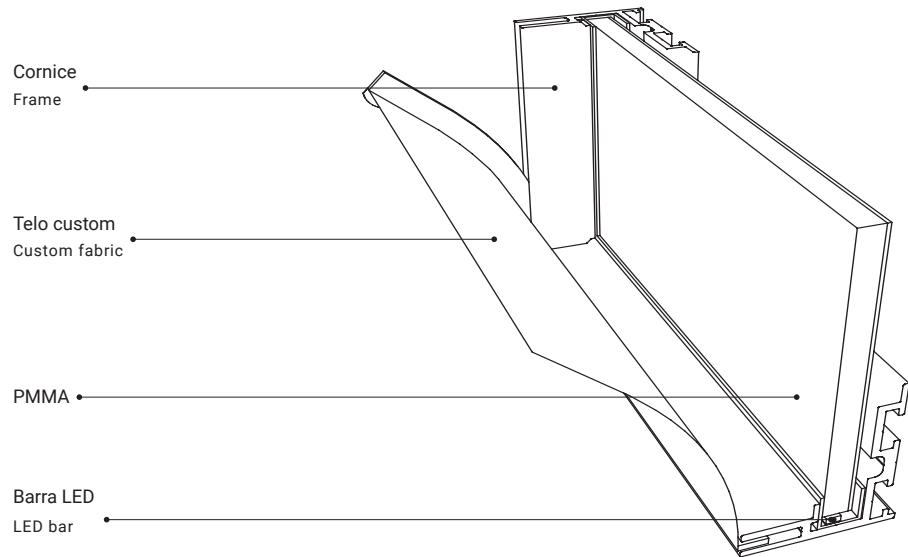

La sostituzione della grafica è intuitiva e veloce, non richiede l'ausilio di attrezzature specifiche, il telo verrà posizionato tramite semplice pressione nella cornice.

Replacing the artwork is quick and intuitive, it does not require any particular tool, and the canvas can be placed simply by pressing it into the frame.

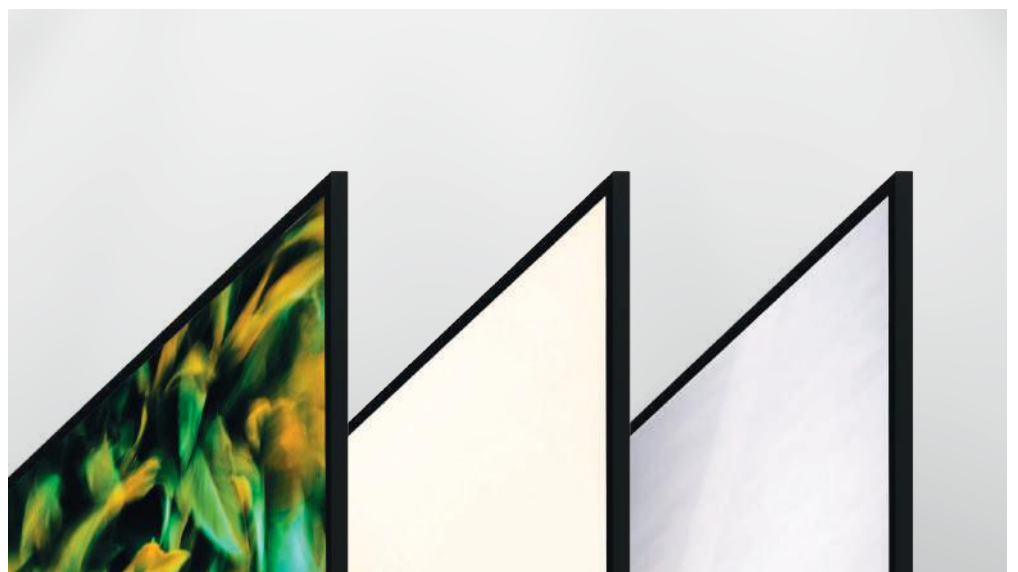



04

Superfici super custom

UNIFORM

L'immaginazione vi porterà dappertutto

Imagination will take you everywhere

^{ITA} Il pannello può essere fornito con diffusore opalino bianco o con stampa grafica (non intercambiabile).

Adatto per l'integrazione di superfici luminose custom, nell'architettura e in qualsiasi tipo di arredo: mobili, specchi, cucine etc.

Prodotto custom da realizzare secondo specifiche e privo di sistemi di fissaggio.

^{EN} The panel could be supplied with white opaline diffuser or graphic print (not interchangeable).

Suitable for the integration of custom light surfaces, in architecture and in any type of decoration: furniture, mirrors, kitchens etc.

Custom product to be realized according to specifications, without fixing systems.



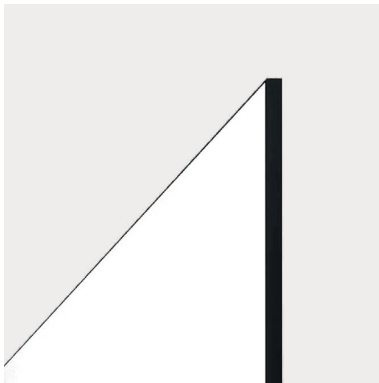

Alluminio
Aluminium

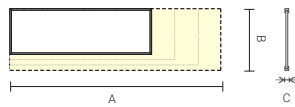
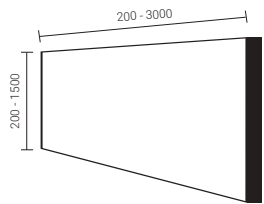

A: Min. 210mm / Max 3000mm
 B: Min. 210mm / Max 2010mm
 C: 12mm / 15mm / 20mm

Alluminio 1mm faccia bianca
 1mm aluminium white face

Cornice
 Frame

Diffusore opale
 Opal diffuser

PMMA

Barra LED
 LED bar

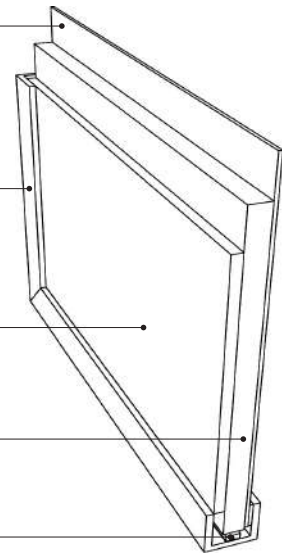

Non ci sono limiti al suo utilizzo: misure, colore del LED, sistemi di installazione sono completamente personalizzabili.

No limits to its use: sizes, LED color, installation systems are compleatly customizable.

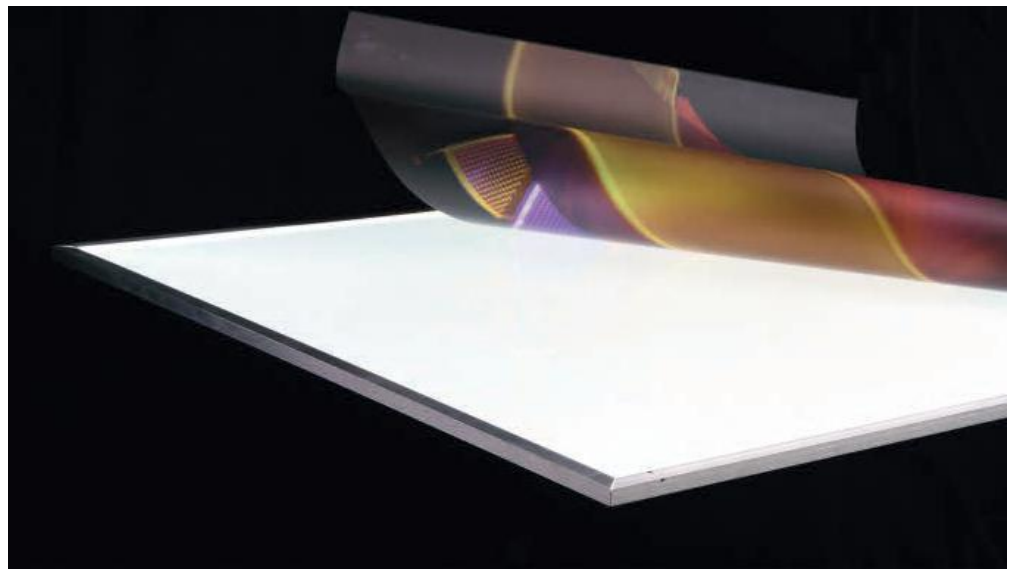



04

Superfici

super custom

EASY

Luce, semplicemente luce

Light, simply light

^{ITA} Adatto per retro-illuminazione di materiali trasparenti o traslucidi: vetro, marmo, onice, superfici con grafiche etc... L'assenza del diffusore opale massimizza la luce in uscita, mantenendo a vista il caratteristico effetto "puntinato" della marcatura laser.

Prodotto custom da realizzare secondo specifiche e privo di sistemi di fissaggio.

^{EN} Suitable for back-lighting of transparent or translucent materials: glass, marble, onyx, surfaces with graphics etc... The absence of the opal diffuser maximizes the output light, keeping in sight the characteristic "dotted" effect of the laser marking.

Custom product to be realized according to specifications and without fixing systems.





Alluminio
Aluminium

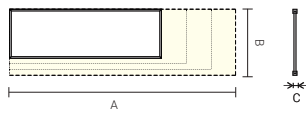
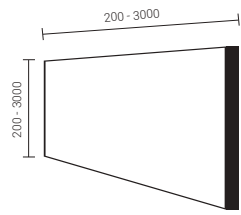

A: Min. 210mm / Max. 3000mm
 B: Min. 210mm / Max. 2010mm
 C: 7mm / 10mm / 12mm

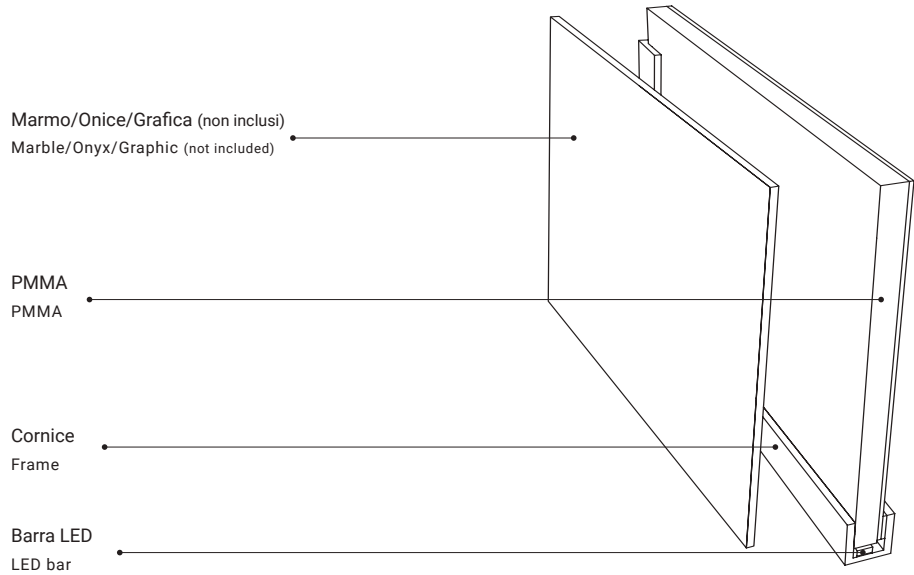

Alcuni esempi di materiali per la retro-illuminazione / Some examples of materials for back lighting

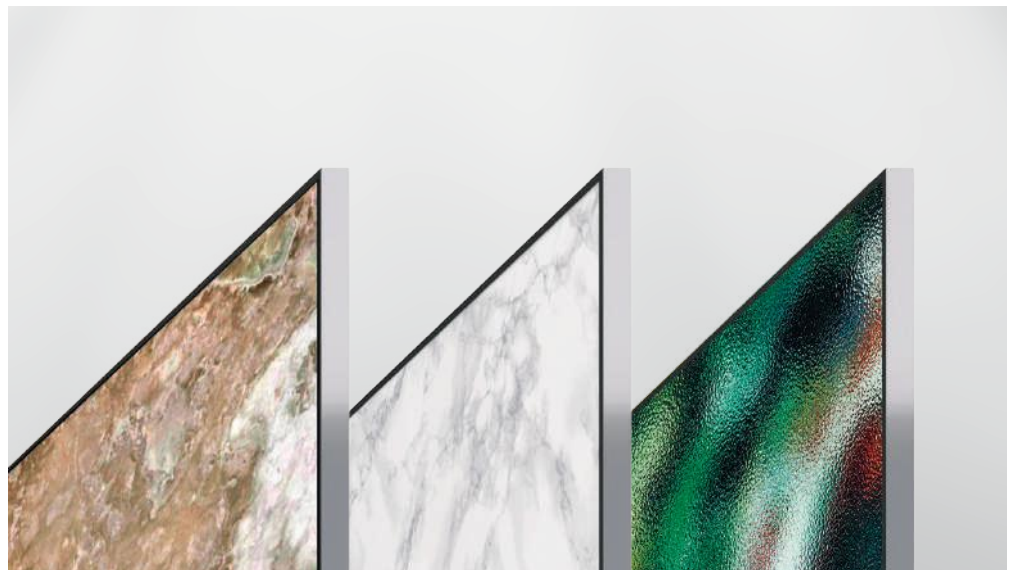

Linee



Lines

“La linea costituisce la massima opposizione all’elemento pittorico primigenio - il punto. L’elemento tempo è in generale molto più riconoscibile nella linea che nel punto in quanto la lunghezza è un concetto temporale. D’altra parte, seguire una linea è temporalmente diverso dal seguire una curva, e quanto più mossa è la curva, tanto più essa si estende nel tempo. Dunque, nella linea le possibilità di uso del tempo sono molteplici”

“The line constitutes the maximum opposition to the primordial pictorial element - the point.

The time element is generally much more recognizable in the line than in the point since length is a temporal concept.

On the other hand, following a line is temporally different from following a curve, and the more moved the curve, the more it extends in time. Therefore, in the line, the possibilities of using time are manifold”

V. Kandinskij



Cassiopea PL



Lunae (in alto / above)
Scorpion IN (a destra / on the right)

Razionalismo contemporaneo

Contemporary rationalism

^{IT} La gamma di prodotti lineari a LED Linee offre un design elegante e prestazioni affidabili, comprendendo varie famiglie, ognuna delle quali si caratterizza per peculiarità distintive che le rendono adatte a un'ampia gamma di applicazioni.

Diverse modalità di installazione:
a incasso, a sospensione, plafone / parete / terra, angolari oppure ideali per esterno.

^{EN} The LED linear light range Lines introduces sleek design and reliable performance, comprising various families, each of which offer distinctive features making them suitable for a wide range of applications.

They can be installed in different ways:
recessed, suspended, ceiling/wall/floor, corner or for outdoor use.



^{IT} Trovano la migliore applicazione in contesti retail e residenziali, hospitality e anche per alcune applicazioni office grazie al basso livello di abbagliamento.

^{EN} They find their best application in retail and residential spaces, including also hospitality and for some office contexts thanks to their low glare level.



Trame di luce da seguire con lo sguardo

Textures of light to follow with the eyes

^{ITA} Linee luminose viaggiano attraverso gli ambienti, tracciando un percorso definito. Gli elementi lineari esplorano gli spazi da illuminare con luce diffusa o d'accento. La luce può dare vita ad atmosfere accoglienti e rilassanti o definire spazi con diverse funzioni.

La gamma 35 si arricchisce della versione da terra 35 Stelo, elegante e sofisticata, e della versione sospesa in verticale 35 Candela.

^{EN} Bright lines move through the environments, tracing a defined path. The linear elements explore spaces, illuminating them with diffused and accent light. Lights contribute to a relaxing and welcoming atmosphere, as well as define spaces with different functions.

The elegant and sophisticated 35 Stelo floor-standing and the 35 Candela vertically suspended light enrich the 35 range.

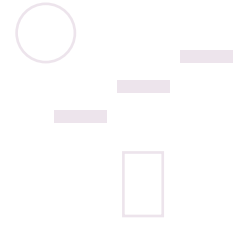

L'arabesque Cult Store – Milano (Architects: Giovanni Pacciani and Claudio Bignazzi - Lighting design: Flux CS)

35 Linear System RGBW in configurazione custom
Custom configuration of 35 Linear System RGBW





Libertà creativa

Creative freedom

^{ITA} Le nostre Linee prevedono lunghezze dei profili standard ma possono essere facilmente adattati alle diverse esigenze dei progetti di lighting design. Anche le finiture e le caratteristiche illuminotecniche possono adattarsi alle diverse richieste. Design, materiali e attenzione ai dettagli per proposte versatili e flessibili che possano soddisfare le esigenze estetiche, dimensionali e funzionali di ogni progetto.

^{EN} The products in the Lines collection have standard profile lengths but can adapt effortlessly to the different needs of lighting design projects. The finishes and lighting characteristics can also adapt to the different needs. Design, materials and attention to detail for versatile and flexible proposals can satisfy aesthetic, dimensional and functional needs of any project.

Luce tra funzione e atmosfera

Light between function and atmosphere

^{ITA} L'elevato grado di protezione IP sommato alla scelta di materiali e componenti resistenti a condizioni ambientali particolari rende alcune Linee adatte per applicazioni in esterni o spazi umidi.

^{EN} The high IP protection rating and the choice of materials and components resistant to particular environmental conditions make some Lines suitable for outdoor or wet spaces applications.



Arrow PL (a sinistra / on the left)
Capricorn (a destra / on the right)



□ **01**

Linee incasso

recessed

Protagonisti discreti: l'essenziale invisibile

Discreet protagonists: the invisible essential

^{ITA} I profili da incasso si nascondono nell'architettura per dare valore alla luce. Ideati per realizzare tagli di luce su pareti o soffitti con il massimo della versatilità: danno forma a composizioni luminose lineari con cornice, sia su cartongesso che in muratura. Design fluido ed essenziale, spessori ridotti e una sorprendente uniformità luminosa, catturano lo sguardo in un percorso infinito.

^{EN} The recessed profiles hide in the architecture to give value to the light. Designed to create cuts of light on walls or ceilings with maximum versatility: they give shape to linear luminous compositions with a frame both on plasterboard and masonry. Fluid and essential design, reduced thicknesses and a marvelous luminous uniformity capture the eye in an infinite path.





Unicorn (in alto / above)
Centaur (a sinistra / on the left)









01

Linee

incasso

recessed



	Products	Pages
	Virgo	96
	Scorpion IN	97
	Lion	98
	Pictor	99
	Unicorn	100
	Bear	101
	Sagittarius	102
	Fenice	104
	Centaur	105

VIRGO

INCASSO / RECESSED

Incasso Recessed

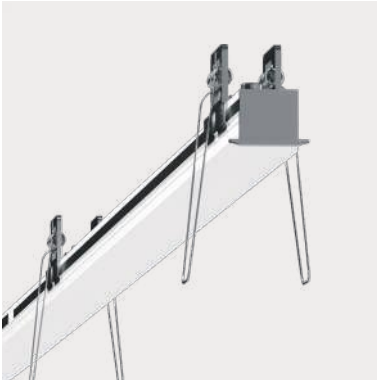

00 **Alluminio**
Alluminium

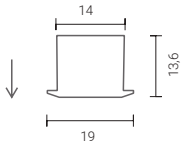

-L10 1 m
0,30 Kg

-L20 2 m
0,60 Kg

Codice base Base code	Ottica Optic	Fissaggio Fixing	Colour T (K)	Finitura Finish	Chiusura Closing
--------------------------	-----------------	---------------------	-----------------	--------------------	---------------------

Customizzabile fino a 2m
Customizable up to 2m

V02 -	O opale / opal	Z 2700K	00	L10
		C 3000K		L20
		N 4000K		

24Vdc

CE  IP20 

Caratteristiche illuminotecniche / Lighting specifications

Dimensione Size (mm)	LED Lumen	Product Lumen		Watt	Vdc	Colour T	CRI
		opal	prismatic				
1003	1900	1330	-	16	24	2700	93
	2000	1400	-	16	24	3000	93
	2100	1470	-	16	24	4000	93
2003	3800	2660	-	32	24	2700	93
	4000	2800	-	32	24	3000	93
	4200	2940	-	32	24	4000	93

Driver da ordinare separatamente / Drivers to be ordered separately

07250 Output 24Vdc 75W
On/Off

Controller da ordinare separatamente
Controller to be ordered separately

CT00050 Dimmer 1 ch
DALI2-PUSH-0/1..10V

CT00052 Dimmer 1 ch
PUSH/WIRELESS

Reference configurator

Il codice prodotto si compone mettendo in fila, da sinistra a destra, i dati contenuti nelle colonne a partire da "Codice base".

The product code is created by putting in sequence the data starting from "Base code", from left to right.

es: **V02-OC00L20**



SCORPION IN INCASSO / RECESSED



01 Bianco White 02 Nero Black 07 Oro Gold

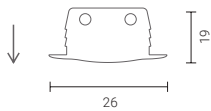

-L10 1 m 0,40 Kg
-L20 2 m 0,80 Kg
-L30 3 m 1,20 Kg

Codice base Ottica Fissaggio Colour Finitura **Chiusura**
 Base code Optic Fixing T (K) Finish Closing

Customizzabile fino a 4m
 Customizable up to 4m

SC2 - **O** opale / opal **Z** 2700K **01** **L10**
C 3000K **02** **L20**
N 4000K **07** **L30**

24Vdc



Caratteristiche illuminotecniche / Lighting specifications

Dimensione Size (mm)	LED Lumen	Product Lumen		Watt	Vdc	Colour T	CRI
		opal	prismatic				
1004	1900	1330	-	16	24	2700	93
	2000	1400	-	16	24	3000	93
	2100	1470	-	16	24	4000	93
2004	3800	2660	-	32	24	2700	93
	4000	2800	-	32	24	3000	93
	4200	2940	-	32	24	4000	93
3004	5700	3990	-	48	24	2700	93
	6000	4200	-	48	24	3000	93
	6300	4410	-	48	24	4000	93

Driver da ordinare separatamente / Drivers to be ordered separately

07250 Output 24Vdc 75W
On/Off

Controller da ordinare separatamente
 Controller to be ordered separately

CT00050 Dimmer 1 ch
DALI2-PUSH-0/1..10V

CT00052 Dimmer 1 ch
PUSH/WIRELESS

Reference configurator

Il codice prodotto si compone mettendo in fila, da sinistra a destra, i dati contenuti nelle colonne a partire da "Codice base".

The product code is created by putting in sequence the data starting from "Base code", from left to right.

es: **SC2-OC02L20**

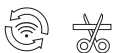

LION

INCASSO / RECESSED

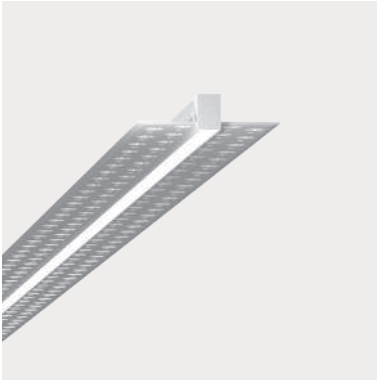

00 Alluminio
Alluminium

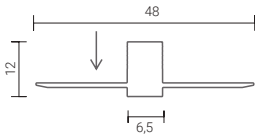

-L10
1 m
0,30 Kg

-L20
2 m
0,60 Kg

Codice base Base code	Ottica Optic	Fissaggio Fixing	Colour T (K)	Finitura Finish	Chiusura Closing
--------------------------	-----------------	---------------------	-----------------	--------------------	---------------------

Customizzabile fino a 2m
Customizable up to 2m

LO -	O opale / opal	Z 2700K	00	L10
		C 3000K		L20
		N 4000K		

24V_{dc}

CE IP20

Caratteristiche illuminotecniche / Lighting specifications

Dimensione Size (mm)	LED Lumen	Product Lumen		Watt	V _{dc}	Colour T	CRI
		opal	prismatic				
1004	1220	915	-	11	24	2700	80
	1280	960	-	11	24	3000	80
	1340	1005	-	11	24	4000	80
2004	2440	1830	-	22	24	2700	80
	2560	1920	-	22	24	3000	80
	2680	2010	-	22	24	4000	80

Driver da ordinare separatamente / Drivers to be ordered separately

07250 Output 24V_{dc} 75W
On/Off

Controller da ordinare separatamente
Controller to be ordered separately

CT00050 Dimmer 1 ch
DALI2-PUSH-0/1..10V

CT00052 Dimmer 1 ch
PUSH/WIRELESS

Reference configurator

Il codice prodotto si compone mettendo in fila, da sinistra a destra, i dati contenuti nelle colonne a partire da "Codice base".

The product code is created by putting in sequence the data starting from "Base code", from left to right.

es: LO-ON00L20



PICTOR IN

INCASSO / RECESSED

Incasso Recessed

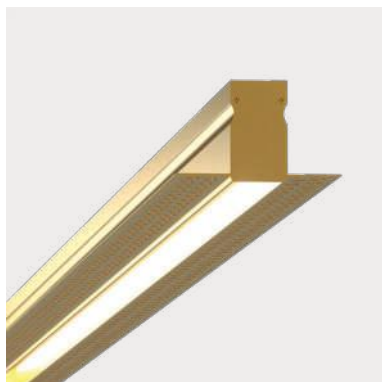

01 Bianco White 02 Nero Black 07 Oro Gold

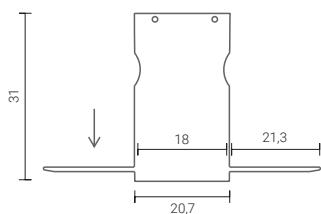

-L10 1 m 0.75 Kg
-L20 2 m 1.50 Kg

Codice base Ottica Fissaggio Colour Finitura Chiusura
Base code Optic Fixing T (K) Finish Closing

Customizzabile fino a 2m
Customizable up to 2m

PC2 -	O opale / opal	Z 2700K	01	L10
		C 3000K	02	L20
		N 4000K	07	

24Vdc



Caratteristiche illuminotecniche / Lighting specifications

Dimensione Size (mm)	LED Lumen	Product Lumen		Watt	Vdc	Colour T	CRI
		opal	prismatic				
1004	1900	1330	-	16	24	2700	93
	2000	1400	-	16	24	3000	93
	2100	1470	-	16	24	4000	93
2004	3800	2660	-	32	24	2700	93
	4000	2800	-	32	24	3000	93
	4200	2940	-	32	24	4000	93

Driver da ordinare separatamente / Drivers to be ordered separately

07250 Output 24Vdc 75W
On/Off

Controller da ordinare separatamente
Controller to be ordered separately

CT00050 Dimmer 1 ch
DALI2-PUSH-0/1..10V

CT00052 Dimmer 1 ch
PUSH/WIRELESS

Reference configurator

Il codice prodotto si compone mettendo in fila, da sinistra a destra, i dati contenuti nelle colonne a partire da "Codice base".

The product code is created by putting in sequence the data starting from "Base code", from left to right.

es: PC2-OC07L10



UNICORN

INCASSO / RECESSED



00 Alluminio
Alluminium

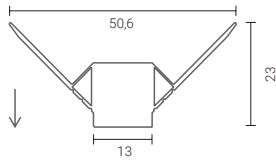

-L10
1 m
0,40 Kg

-L20
2 m
0,80 Kg

Codice base Base code	Ottica Optic	Fissaggio Fixing	Colour T (K)	Finitura Finish	Chiusura Closing
--------------------------	-----------------	---------------------	-----------------	--------------------	---------------------

Customizzabile fino a 2m
Customizable up to 2m

UC2 -	O opale / opal	Z 2700K	00	L10
		C 3000K		L20
		N 4000K		

24Vdc



Caratteristiche illuminotecniche / Lighting specifications

Dimensione Size (mm)	LED Lumen	Product Lumen		Watt	Vdc	Colour T	CRI
		opal	prismatic				
1004	1900	1330	-	16	24	2700	93
	2000	1400	-	16	24	3000	93
	2100	1470	-	16	24	4000	93
2004	3800	2660	-	32	24	2700	93
	4000	2800	-	32	24	3000	93
	4200	2940	-	32	24	4000	93

Driver da ordinare separatamente / Drivers to be ordered separately

07250 Output 24Vdc 75W
On/Off

Controller da ordinare separatamente
Controller to be ordered separately

CT00050 Dimmer 1 ch
DALI2-PUSH-0/1..10V

CT00052 Dimmer 1 ch
PUSH/WIRELESS

Reference configurator

Il codice prodotto si compone mettendo in fila, da sinistra a destra, i dati contenuti nelle colonne a partire da "Codice base".

The product code is created by putting in sequence the data starting from "Base code", from left to right.

es: UC2-OC00L20



BEAR

INCASSO / RECESSED

Incasso Recessed

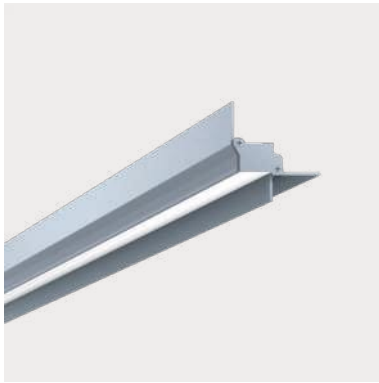

01 Bianco White 02 Nero Black 07 Oro Gold

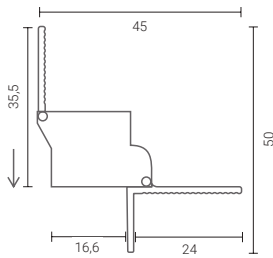

-L10 1 m 0.70 Kg
 -L20 2 m 1.40 Kg
 -L30 2 m 2.10 Kg

Codice base Base code **Ottica** Optic **Fissaggio** Fixing **Colour** T (K) **Finitura** Finish **Chiusura** Closing

Customizzabile fino a 4m
 Customizable up to 4m

BA2 - **O** opale / opal **Z** 2700K **01** **L10**
C 3000K **02** **L20**
N 4000K **07** **L30**

24Vdc

CE IP20

Caratteristiche illuminotecniche / Lighting specifications

Dimensione Size (mm)	LED Lumen	Product Lumen		Watt	Vdc	Colour T	CRI
		opal	prismatic				
1004	1900	1380	-	16	24	2700	93
	2000	1420	-	16	24	3000	93
	2100	1510	-	16	24	4000	93
2004	3800	2760	-	32	24	2700	93
	4000	2840	-	32	24	3000	93
	4200	3020	-	32	24	4000	93
3004	5700	4140	-	48	24	2700	93
	6000	4260	-	48	24	3000	93
	6300	4530	-	48	24	4000	93

Driver da ordinare separatamente / Drivers to be ordered separately

07250 Output 24Vdc 75W
 On/Off

Controller da ordinare separatamente
 Controller to be ordered separately

CT00050 Dimmer 1 ch
 DALI2-PUSH-0/1..10V

CT00052 Dimmer 1 ch
 PUSH/WIRELESS

Reference configurator

Il codice prodotto si compone mettendo in fila, da sinistra a destra, i dati contenuti nelle colonne a partire da "Codice base".

The product code is created by putting in sequence the data starting from "Base code", from left to right.

es: BA2-OC02L30



SAGITTARIUS

INCASSO / RECESSED



01 Bianco White 02 Nero Black 07 Oro Gold

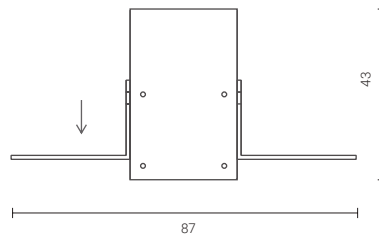

-L10 1 m 1,60 Kg
 -L20 2 m 3,20 Kg
 -L30 3 m 4,80 Kg

Codice base Base code Ottica Optic Fissaggio Fixing Colour T (K) Finitura Finish Chiusura Closing

Customizzabile fino a 4m
 Customizable up to 4m

SG2 -	O opale / opal	Z 2700K	01	L10
	P prismatico / prismatic	C 3000K	02	L20
		N 4000K	07	L30

24Vdc



Caratteristiche illuminotecniche / Lighting specifications

Dimensione Size (mm)	LED Lumen	Product Lumen		Watt	Vdc	Colour T	CRI
		opal	prismatic				
1004	1900	1330	1520	16	24	2700	93
	2000	1400	1600	16	24	3000	93
	2100	1470	1680	16	24	4000	93
2004	3800	2660	3040	32	24	2700	93
	4000	2800	3200	32	24	3000	93
	4200	2940	3360	32	24	4000	93
3004	5700	3990	4560	48	24	2700	93
	6000	4200	4800	48	24	3000	93
	6300	4410	5040	48	24	4000	93

Driver da ordinare separatamente / Drivers to be ordered separately

07250 Output 24Vdc 75W
 On/Off

Controller da ordinare separatamente
 Controller to be ordered separately

CT00050 Dimmer 1 ch
 DALI2-PUSH-0/1..10V

CT00052 Dimmer 1 ch
 PUSH/WIRELESS

Reference configurator

Il codice prodotto si compone mettendo in fila, da sinistra a destra, i dati contenuti nelle colonne a partire da "Codice base".

The product code is created by putting in sequence the data starting from "Base code", from left to right.

es: SG2-PC02L20





Sagittarius

FENICE

INCASSO / RECESSED



01 Bianco White 02 Nero Black 07 Oro Gold

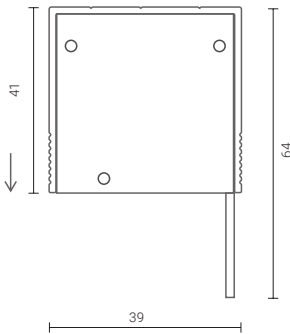

-L10 1 m
-L20 2 m
1,60 Kg 3,20 Kg

Codice base Base code	Ottica Optic	Fissaggio Fixing	Colour T (K)	Finitura Finish	Chiusura Closing
--------------------------	-----------------	---------------------	-----------------	--------------------	---------------------

Customizzabile fino a 2m
Customizable up to 2m

FN2 -	O opale / opal	Z 2700K	01	L10
		C 3000K	02	L20
		N 4000K	07	

24Vdc



Caratteristiche illuminotecniche / Lighting specifications

Dimensione Size (mm)	LED Lumen	Product Lumen	Watt	V _{dc}	Colour T	CRI	
1004		opal -					
	1900	1330	-	16	24	2700	93
	2000	1400	-	16	24	3000	93
2004	2100	1470	-	16	24	4000	93
	3800	2660	-	32	24	2700	93
	4000	2800	-	32	24	3000	93
	4200	2940	-	32	24	4000	93

Driver da ordinare separatamente / Drivers to be ordered separately

07250 Output 24Vdc 75W
On/Off

Controller da ordinare separatamente
Controller to be ordered separately

CT00050 Dimmer 1 ch
DALI2-PUSH-0/1..10V

CT00052 Dimmer 1 ch
PUSH/WIRELESS

Reference configurator

Il codice prodotto si compone mettendo in fila, da sinistra a destra, i dati contenuti nelle colonne a partire da "Codice base".

The product code is created by putting in sequence the data starting from "Base code", from left to right.

es: LO-ON07L20



CENTAUR

INCASSO / RECESSED

Incasso Recessed



01 **Bianco** White
02 **Nero** Black
07 **Oro** Gold

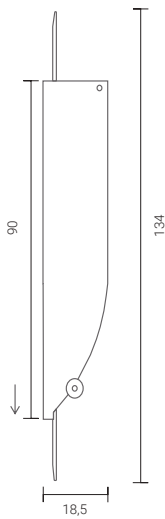

-L10 1 m
-L20 2 m

0,92 Kg 1,84 Kg

Codice base Base code	Ottica Optic	Fissaggio Fixing	Colour T (K)	Finitura Finish	Chiusura Closing
--------------------------	-----------------	---------------------	-----------------	--------------------	---------------------

Customizzabile fino a 2m
Customizable up to 2m

CU2 -	O opale / opal	Z 2700K	01	L10
		C 3000K	02	L20
		N 4000K	07	

24Vdc



Caratteristiche illuminotecniche / Lighting specifications

Dimensione Size (mm)	LED Lumen	Product Lumen		Watt	Vdc	Colour T	CRI
		opal	prismatic				
1004	1900	1425	-	16	24	2700	93
	2000	1500	-	16	24	3000	93
	2100	1575	-	16	24	4000	93
2004	3800	2850	-	32	24	2700	93
	4000	3000	-	32	24	3000	93
	4200	3150	-	32	24	4000	93

Driver da ordinare separatamente / Drivers to be ordered separately

07250 Output 24Vdc 75W
On/Off

Controller da ordinare separatamente
Controller to be ordered separately

CT00050 Dimmer 1 ch
DALI2-PUSH-0/1..10V

CT00052 Dimmer 1 ch
PUSH/WIRELESS

Reference configurator

Il codice prodotto si compone mettendo in fila, da sinistra a destra, i dati contenuti nelle colonne a partire da "Codice base".

The product code is created by putting in sequence the data starting from "Base code", from left to right.

es: **CU2-OZ02L20**



 **02**

Linee

parete / plafone / terra

wall / ceiling / floor

Idee di luce

Light concepts

^{ITA} Linee di luce dal profilo essenziale che si integrano perfettamente nell'architettura che le circonda. Un perfetto mix tra eleganza e semplicità, che valorizza ogni progetto di interior. Trovano applicazione in contesti retail, hospitality, contract e residenziali.

35 Stelo, piantana lineare, è fornita con pulsantiera per la gestione delle accensioni (120°+240°) e della dimmerazione.

^{EN} Lines of light with an essential profile integrate perfectly into the architecture around them: a perfect mix of elegance and simplicity, which enhances any interior design project. They find applications in retail, hospitality, contract and residential contexts.

35 Stelo, a linear floor lamp, is supplied with a push-button panel for switching on (120°+240°) and dimming.

35 Stelo in finitura oro satinato
35 Stelo with satin gold finish















02

Linee

parete / plafone / terra

wall / ceiling / floor



	Products	Pages
	Orion PL	110
	Taurus	112
	Arrow PL	113
	Wolf	114
	Vela	115
	Ara PL	116
	Dolphin PL	117
	Cassiopea PL	118
	Dorado PL	119
	Mira	120
	35 Stelo	121

ORION PL

PLAFONE / CEILING



01 Bianco White 02 Nero Black 07 Oro Gold

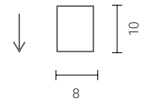

-L10 1 m **-L20** 2 m
0,20 Kg 0,40 Kg

Codice base Base code	Ottica Optic	Fissaggio Fixing	Colour T (K)	Finitura Finish	Chiusura Closing
--------------------------	-----------------	---------------------	-----------------	--------------------	---------------------

Customizzabile fino a 4m
Customizable up to 4m

ON -	O opale / opal	PL	Z 2700K	01	L10	
			C 3000K	02		L20
			N 4000K	07		

24Vdc

CE IP20

Caratteristiche illuminotecniche / Lighting specifications

Dimensione Size (mm)	LED Lumen	Product Lumen		Watt	Vdc	Colour T	CRI
		opal	prismatic				
1002	1220	915	-	11	24	2700	80
	1280	960	-	11	24	3000	80
	1340	1005	-	11	24	4000	80
2002	2440	1830	-	22	24	2700	80
	2560	1920	-	22	24	3000	80
	2680	2010	-	22	24	4000	80

Driver da ordinare separatamente / Drivers to be ordered separately

07250 Output 24Vdc 75W
On/Off

Controller da ordinare separatamente
Controller to be ordered separately

CT00050 Dimmer 1 ch
DALI2-PUSH-0/1..10V

CT00052 Dimmer 1 ch
PUSH/WIRELESS

Reference configurator

Il codice prodotto si compone mettendo in fila, da sinistra a destra, i dati contenuti nelle colonne a partire da "Codice base".

The product code is created by putting in sequence the data starting from "Base code", from left to right.

es: **ON-OPLC01L10**





Orion PL

TAURUS

PLAFONE / CEILING



01 Bianco White 02 Nero Black 07 Oro Gold

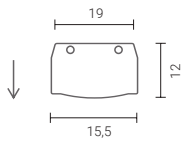

-L10
1 m
0,62 Kg

-L20
2 m
1,24 Kg

-L30
2 m
1,86 Kg

Codice base Base code	Ottica Optic	Fissaggio Fixing	Colour T (K)	Finitura Finish	Chiusura Closing
--------------------------	-----------------	---------------------	-----------------	--------------------	---------------------

Customizzabile fino a 4m
Customizable up to 4m

TU2 -	O opale / opal	PL	Z 2700K	01	L10
			C 3000K	02	L20
			N 4000K	07	L30

24Vdc

CE IP20

Caratteristiche illuminotecniche / Lighting specifications

Dimensione Size (mm)	LED Lumen	Product Lumen		Watt	Vdc	Colour T	CRI
		opal	prismatic				
1004	1900	1330	-	16	24	2700	93
	2000	1400	-	16	24	3000	93
	2100	1470	-	16	24	4000	93
2004	3800	2660	-	32	24	2700	93
	4000	2800	-	32	24	3000	93
	4200	2940	-	32	24	4000	93
3004	5700	3990	-	48	24	2700	93
	6000	4200	-	48	24	3000	93
	6300	4410	-	48	24	4000	93

Driver da ordinare separatamente / Drivers to be ordered separately

07250 Output 24Vdc 75W
On/Off

Controller da ordinare separatamente
Controller to be ordered separately

CT00050 Dimmer 1 ch
DALI2-PUSH-0/1..10V

CT00052 Dimmer 1 ch
PUSH/WIRELESS

Reference configurator

Il codice prodotto si compone mettendo in fila, da sinistra a destra, i dati contenuti nelle colonne a partire da "Codice base".

The product code is created by putting in sequence the data starting from "Base code", from left to right.

es: TU2-OPLZ01L10



ARROW PL

PLAFONE / CEILING

Parete / plafone / terra Wall / ceiling / floor



01 Bianco White 02 Nero Black 07 Oro Gold

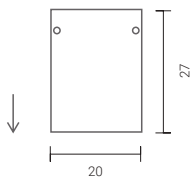

-L10 1 m 0.46 Kg
 -L20 2 m 0.92 Kg
 -L30 2 m 1.38 Kg

Codice base Base code	Ottica Optic	Fissaggio Fixing	Colour T (K)	Finitura Finish	Chiusura Closing
--------------------------	-----------------	---------------------	-----------------	--------------------	---------------------

Luce 180°. Customizzabile fino a 2m
 Light 180°. Customizable up to 2m

AW2 -	O opale / opal	PL	Z 2700K	01	L10
			C 3000K	02	L20
			N 4000K	07	L30

24Vdc

CE IP20

Caratteristiche illuminotecniche / Lighting specifications

Dimensione Size (mm)	LED Lumen	Product Lumen		Watt	Vdc	Colour T	CRI
		opal	prismatic				
1004	1900	1273	-	16	24	2700	93
	2000	1340	-	16	24	3000	93
	2100	1407	-	16	24	4000	93
2004	3800	2546	-	32	24	2700	93
	4000	2680	-	32	24	3000	93
	4200	2814	-	32	24	4000	93
3004	5700	3819	-	48	24	2700	93
	6000	4020	-	48	24	3000	93
	6300	4221	-	48	24	4000	93

Driver da ordinare separatamente / Drivers to be ordered separately

07250 Output 24Vdc 75W
On/Off

Controller da ordinare separatamente
Controller to be ordered separately

CT00050 Dimmer 1 ch
DALI2-PUSH-0/1..10V

CT00052 Dimmer 1 ch
PUSH/WIRELESS

Reference configurator

Il codice prodotto si compone mettendo in fila, da sinistra a destra, i dati contenuti nelle colonne a partire da "Codice base".

The product code is created by putting in sequence the data starting from "Base code", from left to right.

es: AW2-OPLC01L10



WOLF

PLAFONE / CEILING

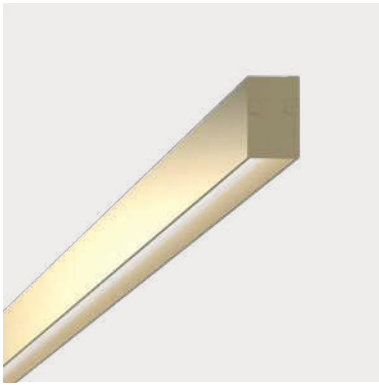

01 Bianco White 02 Nero Black 07 Oro Gold

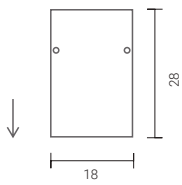

-L10
1 m
0,65 Kg

-L20
2 m
1,30 Kg

-L30
3 m
1,95 Kg

Codice base Base code	Ottica Optic	Fissaggio Fixing	Colour T (K)	Finitura Finish	Chiusura Closing
--------------------------	-----------------	---------------------	-----------------	--------------------	---------------------

Profilo luce recessa. Customizzabile fino a 4m
Profile recess light. Customizable up to 4m

W02 -	O opale / opal	PL	Z 2700K	01	L10
			C 3000K	02	L20
			N 4000K	07	L30

24Vdc

CE IP20

Caratteristiche illuminotecniche / Lighting specifications

Dimensione Size (mm)	LED Lumen	Product Lumen		Watt	Vdc	Colour T	CRI
		opal	prismatic				
1004	1900	1330	-	16	24	2700	93
	2000	1400	-	16	24	3000	93
	2100	1470	-	16	24	4000	93
2004	3800	2660	-	32	24	2700	93
	4000	2800	-	32	24	3000	93
	4200	2940	-	32	24	4000	93
3004	5700	3990	-	48	24	2700	93
	6000	4200	-	48	24	3000	93
	6300	4410	-	48	24	4000	93

Driver da ordinare separatamente / Drivers to be ordered separately

07250 Output 24Vdc 75W
On/Off

Controller da ordinare separatamente
Controller to be ordered separately

CT00050 Dimmer 1 ch
DALI2-PUSH-0/1..10V

CT00052 Dimmer 1 ch
PUSH/WIRELESS

Reference configurator

Il codice prodotto si compone mettendo in fila, da sinistra a destra, i dati contenuti nelle colonne a partire da "Codice base".

The product code is created by putting in sequence the data starting from "Base code", from left to right.

es: **W02-OPLZ01L30**



VELA

PLAFONE / CEILING

Parete / plafone / terra Wall / ceiling / floor



01 Bianco White 02 Nero Black 07 Oro Gold

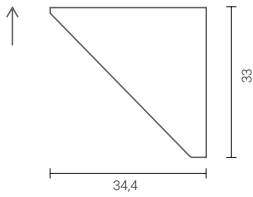

-L10 1 m 0.30 Kg
-L20 2 m 0.60 Kg
-L30 3 m 0.90 Kg

Codice base Base code	Ottica Optic	Fissaggio Fixing	Colour T (K)	Finitura Finish	Chiusura Closing
--------------------------	-----------------	---------------------	-----------------	--------------------	---------------------

Customizzabile fino a 4m
Customizable up to 4m

VL2 -	O opale / opal	PL	Z 2700K	01	L10
			C 3000K	02	L20
			N 4000K	07	L30

24Vdc

CE IP20

Caratteristiche illuminotecniche / Lighting specifications

Dimensione Size (mm)	LED Lumen	Product Lumen		Watt	Vdc	Colour T	CRI
		opal	prismatic				
1004	1900	1425	-	16	24	2700	93
	2000	1500	-	16	24	3000	93
	2100	1575	-	16	24	4000	93
2004	3800	2850	-	32	24	2700	93
	4000	3000	-	32	24	3000	93
	4200	3150	-	32	24	4000	93
3004	5700	4275	-	48	24	2700	93
	6000	4500	-	48	24	3000	93
	6300	4725	-	48	24	4000	93

Driver da ordinare separatamente / Drivers to be ordered separately

07250 Output 24Vdc 75W
On/Off

Controller da ordinare separatamente
Controller to be ordered separately

CT00050 Dimmer 1 ch
DALI2-PUSH-0/1..10V

CT00052 Dimmer 1 ch
PUSH/WIRELESS

Reference configurator

Il codice prodotto si compone mettendo in fila, da sinistra a destra, i dati contenuti nelle colonne a partire da "Codice base".

The product code is created by putting in sequence the data starting from "Base code", from left to right.

es: VL2-OPLZ01L30



ARA PL

PLAFONE / CEILING



01 Bianco White 02 Nero Black 07 Oro Gold

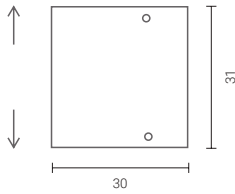

-L10 1 m 0,90 Kg
 -L20 2 m 1,80 Kg
 -L30 3 m 2,70 Kg

Codice base Base code	Ottica Optic	Fissaggio Fixing	Colour T (K)	Finitura Finish	Chiusura Closing
--------------------------	-----------------	---------------------	-----------------	--------------------	---------------------

Customizzabile fino a 4m
 Customizable up to 4m

ABE -	O opale / opal	ST	Z 2700K	01	L10
			C 3000K	02	L20
			N 4000K	07	L30

24Vdc

CE IP20

Caratteristiche illuminotecniche / Lighting specifications

Dimensione Size (mm)	LED Lumen	Product Lumen		Watt	Vdc	Colour T	CRI
		opal	prismatic				
1008	1900	1330	-	32	24	2700	93
	2000	1400	-	32	24	3000	93
	2100	1470	-	32	24	4000	93
2008	3800	2660	-	64	24	2700	93
	4000	2800	-	64	24	3000	93
	4200	2940	-	64	24	4000	93
3008	5700	3990	-	96	24	2700	93
	6000	4200	-	96	24	3000	93
	6300	4410	-	96	24	4000	93

Driver da ordinare separatamente / Drivers to be ordered separately

07145 Output 24Vdc 150W
On/Off

Controller da ordinare separatamente
 Controller to be ordered separately

CT00050 Dimmer 1 ch
DALI2-PUSH-0/1..10V

CT00052 Dimmer 1 ch
PUSH/WIRELESS

Reference configurator

Il codice prodotto si compone mettendo in fila, da sinistra a destra, i dati contenuti nelle colonne a partire da "Codice base".

The product code is created by putting in sequence the data starting from "Base code", from left to right.

es: ABE-OSTZ01L30



DOLPHIN

PLAFONE / CEILING

Parete / plafone / terra Wall / ceiling / floor



01 Bianco White 02 Nero Black 07 Oro Gold

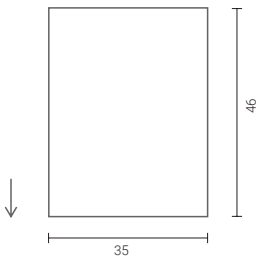

-L10
1 m
1,10 Kg

-L20
2 m
2,30 Kg

-L30
2 m
3,45 Kg

Codice base Base code	Ottica Optic	Fissaggio Fixing	Colour T (K)	Finitura Finish	Dimming Dimming	Chiusura Closing
Alimentatore e centralina interne al profilo. Customizzabile fino a 4m Driver and control unit inside the profile. Customizable up to 4m						
D02 -	O opale / opal	PL	Z 2700K	01	IO On/Off	L10
	P prismatico / prismatic		C 3000K	02	DP Dali	L20
			N 4000K	07		L30

24Vdc

CE IP20

Caratteristiche illuminotecniche / Lighting specifications

Dimensione Size (mm)	LED Lumen	Product Lumen		Watt	V _{ac}	Colour T	CRI
		opal	prismatic				
1004	1900	1330	1520	16	200~240	2700	93
	2000	1400	1600	16	200~240	3000	93
	2100	1470	1680	16	200~240	4000	93
2004	3800	2660	3040	32	200~240	2700	93
	4000	2800	3200	32	200~240	3000	93
	4200	2940	3360	32	200~240	4000	93
3004	5700	3990	4560	48	200~240	2700	93
	6000	4200	4800	48	200~240	3000	93
	6300	4410	5040	48	200~240	4000	93

Reference configurator

Il codice prodotto si compone mettendo in fila, da sinistra a destra, i dati contenuti nelle colonne a partire da "Codice base".

The product code is created by putting in sequence the data starting from "Base code", from left to right.

es: D02-OPLC01DPL10



CASSIOPEA

PLAFONE / CEILING



01 Bianco White 02 Nero Black 07 Oro Gold

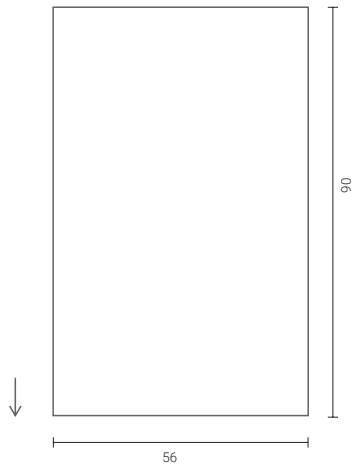

-L10 1 m **-L20** 2 m **-L30** 3 m

3,00 Kg 6,00 Kg 9,00 Kg

Codice base Base code	Ottica Optic	Fissaggio Fixing	Colour T (K)	Finitura Finish	Dimming Dimming	Chiusura Closing
--------------------------	-----------------	---------------------	-----------------	--------------------	--------------------	---------------------

Alimentatore e centralina interne al profilo. Customizzabile fino a 4m
Driver and control unit inside the profile. Customizable up to 4m

CA2 -	O opale / opal	PL	Z 2700K	01	IO On/Off	L10
	P prismatico / prismatic		C 3000K	02	DP Dali	L20
			N 4000K	07		L30

220~240 Vac

CE IP20

Caratteristiche illuminotecniche / Lighting specifications

Dimensione Size (mm)	LED Lumen	Product Lumen		Watt	Vac	Colour T	CRI
		opal	prismatic				
1004	1900	1330	1520	16	200~240	2700	93
	2000	1400	1600	16	200~240	3000	93
	2100	1470	1680	16	200~240	4000	93
2004	3800	2660	3040	32	200~240	2700	93
	4000	2800	3200	32	200~240	3000	93
	4200	2940	3360	32	200~240	4000	93
3004	5700	3990	4560	48	200~240	2700	93
	6000	4200	4800	48	200~240	3000	93
	6300	4410	5040	48	200~240	4000	93

Reference configurator

Il codice prodotto si compone mettendo in fila, da sinistra a destra, i dati contenuti nelle colonne a partire da "Codice base".

The product code is created by putting in sequence the data starting from "Base code", from left to right.

es: CA2-OPLZ01DPL30



DORADO PL

PLAFONE / CEILING

Parete / plafone / terra Wall / ceiling / floor



01 Bianco White 02 Nero Black 07 Oro Gold

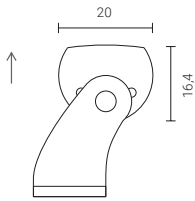

-L10 1 m 0.48 Kg
-L20 2 m 0.96 Kg

Codice base Base code	Ottica Optic	Fissaggio Fixing	Colour T (K)	Finitura Finish	Chiusura Closing
--------------------------	-----------------	---------------------	-----------------	--------------------	---------------------

Profilo orientabile. Customizzabile fino a 4m
Adjustable profile. Customizable up to 4m

DR2 -	O opale / opal	PL	Z 2700K	01	L10
			C 3000K	02	L20
			N 4000K	07	

24Vdc

CE IP20

Caratteristiche illuminotecniche / Lighting specifications

Dimensione Size (mm)	LED Lumen	Product Lumen		Watt	Vdc	Colour T	CRI
		opal	prismatic				
1004	1900	1330	-	16	24	2700	93
	2000	1400	-	16	24	3000	93
	2100	1470	-	16	24	4000	93
2004	3800	2660	-	32	24	2700	93
	4000	2800	-	32	24	3000	93
	4200	2940	-	32	24	4000	93

Driver da ordinare separatamente / Drivers to be ordered separately

07250 Output 24Vdc 75W
On/Off

Controller da ordinare separatamente
Controller to be ordered separately

CT00050 Dimmer 1 ch
DALI2-PUSH-0/1..10V

CT00052 Dimmer 1 ch
PUSH/WIRELESS

Reference configurator

Il codice prodotto si compone mettendo in fila, da sinistra a destra, i dati contenuti nelle colonne a partire da "Codice base".

The product code is created by putting in sequence the data starting from "Base code", from left to right.

es: DR2-2PLZ01L10



MIRA

PLAFONE / CEILING



01 Bianco White 02 Nero Black 07 Oro Gold

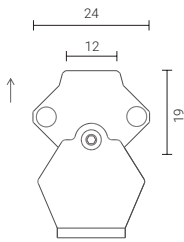

-L018 0.234 m
-L030 0.328 m
-L048 0.508 m

0.20 Kg 0.40 Kg 0.60 Kg

Codice base Base code **Ottica** Optic **Fissaggio** Fixing **Colour** T (K) **Finitura** Finish **Chiusura** Closing

Customizzabile fino a 4m
 Customizable up to 4m

MI -	1 10°	PL	Z 2700K	01	L018
	2 25°		C 3000K	02	L030
	4 40°		N 4000K	07	L048

24Vdc

CE IP40

Caratteristiche illuminotecniche / Lighting specifications

Dimensione Size (mm)	LED Lumen	Product Lumen		Watt	Vdc	Colour T	CRI
		opal	prismatic				
234	456	401	-	3	24	2700	90
	489	430	-	3	24	3000	90
	495	436	-	3	24	4000	90
328	760	669	-	5	24	2700	90
	815	717	-	5	24	3000	90
	825	726	-	5	24	4000	90
508	1216	1070	-	8	24	2700	90
	1304	1148	-	8	24	3000	90
	1320	1162	-	8	24	4000	90

Driver da ordinare separatamente / Drivers to be ordered separately

07200 Output 24Vdc 15W
On/Off

Controller da ordinare separatamente
 Controller to be ordered separately

CT00050 Dimmer 1 ch
DALI2-PUSH-0/1..10V

CT00052 Dimmer 1 ch
PUSH/WIRELESS

Reference configurator

Il codice prodotto si compone mettendo in fila, da sinistra a destra, i dati contenuti nelle colonne a partire da "Codice base".

The product code is created by putting in sequence the data starting from "Base code", from left to right.

es: MI-OPLZ01L018



35 STELO

TERRA / FLOOR

Parete / plafone / terra Wall / ceiling / floor



- 12 62** Nero anodizzato + diffusore opale
Anodized black + opal diffuser
- 04 62** Bianco + diffusore opale
White + opal diffuser
- 10 62** Oro satinato + diffusore opale
Satin gold + opal diffuser
- 18 62** Nickel spazzolato + diffusore opale
Brushed nickel + opal diffuser

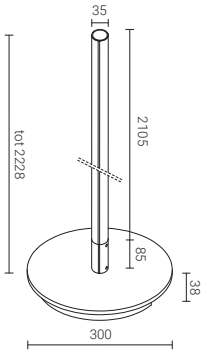

Codice base Base code	Colour T (K)	Finitura Finish
--------------------------	-----------------	--------------------

Con base per applicazione a pavimento e pulsantiera per doppia accensione 120° + 240° e dimming / With base for floor application and push-button pad for double switch 120° + 240° and dimming

456-230	C 2700K	-0462
	B 3000K	-1062
		-1262
		-1862

220-240V

CE IP20

Caratteristiche illuminotecniche / Lighting specifications

Watt	LED Lumen	Product Lumen	Colour T (K)	CRI
21+42	6615	3691	2700	90
	6930	3867	3000	90

Reference configurator

Il codice prodotto si compone mettendo in fila, da sinistra a destra, i dati contenuti nelle colonne a partire da "Codice base".

The product code is created by putting in sequence the data starting from "Base code", from left to right.

es: **456-230B-1262**

Cover fumé / Smoked diffuser

Quando Trentacinque (35) è spento, la cover fumé mantiene l'effetto di finitura nera dando l'impressione che l'alluminio e il diffusore siano un unico elemento continuo.

The smoked diffuser enables a continuous effect of black finish when the light is off, giving the impression that the metal parts and the diffuser are one and the same part.

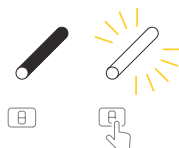

Accessori / Accessories

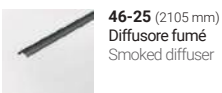

**03**

Linee angolare

corner

Linearità al tuo servizio

Linearity at the service of creativity

^{ITA} Le Linee corner sono ideali per dare risalto a oggetti o ambienti, e si prestano per essere applicate in vetrine, sottopensili, mensole, armadiature o velette in cartongesso. Grazie alla loro conformazione, si inseriscono perfettamente nell'angolo, aderendo alle superfici e proiettando la luce in modo assolutamente centrato. Tutti i modelli di questa categoria hanno uno spessore estremamente ridotto (massimo 16mm): risultano quindi praticamente impercettibili, lasciando spazio alla sola luce emessa.

^{EN} The corner lines are ideal for highlighting objects or spaces and are suitable for application in display cases, under wall units, shelves, wardrobes or plasterboard veils. Thanks to their conformation, they fit perfectly into the corner, adhering to the surfaces and projecting the light in an absolutely centered way. All the models in this category have an extremely reduced thickness (maximum 16mm): they are, therefore, almost invisible, leaving space only for the light emitted.

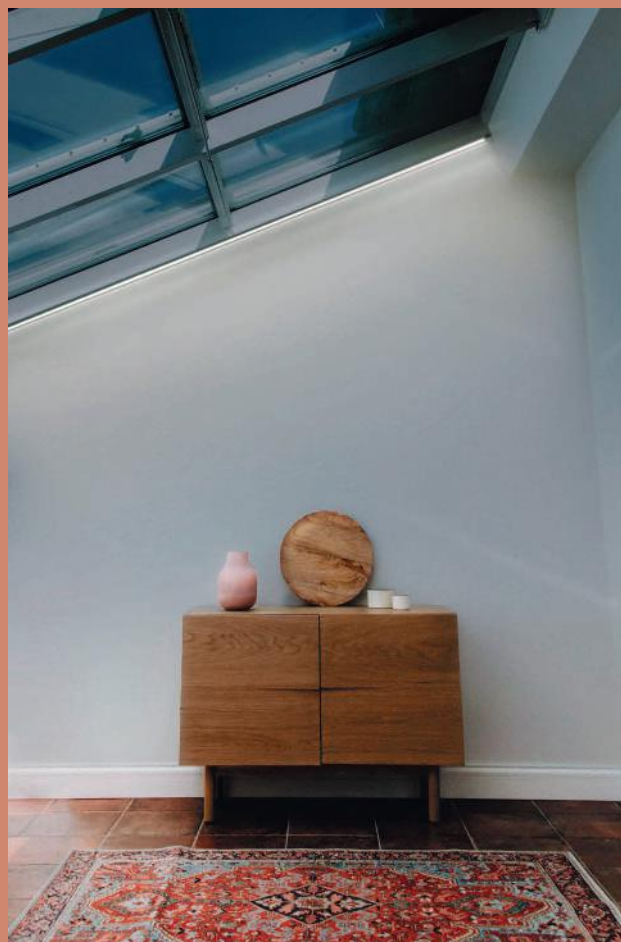



Aries (in alto / above)
Lyra R (a sinistra / on the left)

03

Linee

angolare

corner



	Products	Pages
	Aries	126
	Lyra R	128
	Lyra S	129

ARIES

ANGOLARE / ANGULAR



01 Bianco White 02 Nero Black 07 Oro Gold

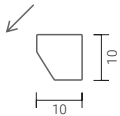

-L10
1 m
0,30 Kg

-L20
2 m
0,60 Kg

Codice base Base code	Ottica Optic	Fissaggio Fixing	Colour T (K)	Finitura Finish	Chiusura Closing
--------------------------	-----------------	---------------------	-----------------	--------------------	---------------------

Customizzabile fino a 4m
Customizable up to 4m

AE -	O opale / opal	PL	Z 2700K	01	L10
			C 3000K	02	L20
			N 4000K	07	

24Vdc

CE IP20

Caratteristiche illuminotecniche / Lighting specifications

Dimensione Size (mm)	LED Lumen	Product Lumen		Watt	Vdc	Colour T	CRI
		opal	prismatic				
1003	1220	854	-	11	24	2700	80
	1280	896	-	11	24	3000	80
	1340	938	-	11	24	4000	80
2003	2440	1708	-	22	24	2700	80
	2560	1792	-	22	24	3000	80
	2680	1876	-	22	24	4000	80

Driver da ordinare separatamente / Drivers to be ordered separately

07250 Output 24Vdc 75W
On/Off

Controller da ordinare separatamente
Controller to be ordered separately

CT00050 Dimmer 1 ch
DALI2-PUSH-0/1..10V

CT00052 Dimmer 1 ch
PUSH/WIRELESS

Reference configurator

Il codice prodotto si compone mettendo in fila, da sinistra a destra, i dati contenuti nelle colonne a partire da "Codice base".

The product code is created by putting in sequence the data starting from "Base code", from left to right.

es: AE-OPLZ01L10





Aries

LYRA R

ANGOLARE / ANGULAR

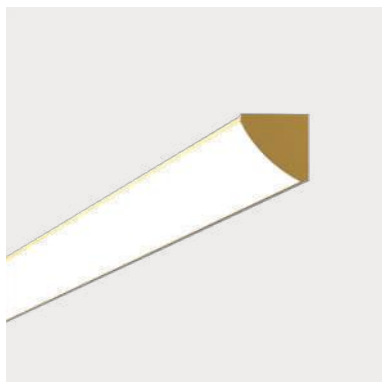

01 Bianco White 02 Nero Black 07 Oro Gold

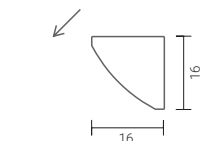

-L10 1 m 0,30 Kg
-L20 2 m 0,60 Kg

Codice base Base code	Ottica Optic	Fissaggio Fixing	Colour T (K)	Finitura Finish	Chiusura Closing
--------------------------	-----------------	---------------------	-----------------	--------------------	---------------------

Customizzabile fino a 2m
Customizable up to 2m

LR2 -	O opale / opal	PL	Z 2700K	01	L10
			C 3000K	02	L20
			N 4000K	07	

24Vdc

CE IP20

Caratteristiche illuminotecniche / Lighting specifications

Dimensione Size (mm)	LED Lumen	Product Lumen		Watt	Vdc	Colour T	CRI
		opal	prismatic				
1003	1900	1235	-	16	24	2700	93
	2000	1300	-	16	24	3000	93
	2100	1365	-	16	24	4000	93
2003	3800	2470	-	32	24	2700	93
	4000	2600	-	32	24	3000	93
	4200	2730	-	32	24	4000	93

Driver da ordinare separatamente / Drivers to be ordered separately

07250 Output 24Vdc 75W
On/Off

Controller da ordinare separatamente
Controller to be ordered separately

CT00050 Dimmer 1 ch
DALI2-PUSH-0/1..10V

CT00052 Dimmer 1 ch
PUSH/WIRELESS

Reference configurator

Il codice prodotto si compone mettendo in fila, da sinistra a destra, i dati contenuti nelle colonne a partire da "Codice base".

The product code is created by putting in sequence the data starting from "Base code", from left to right.

es: LR2-OPLZ02L20

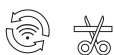

LYRA S

ANGOLARE / ANGULAR

[Angolare](#) [Corner](#)

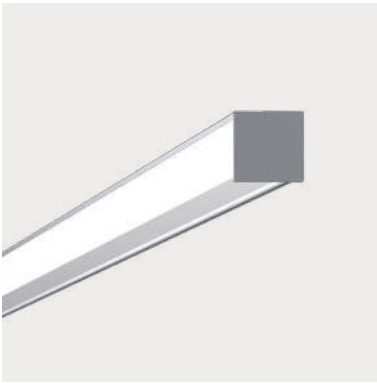

01 Bianco White 02 Nero Black 07 Oro Gold

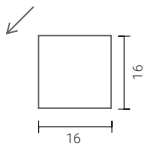

-L10 1 m 0,30 Kg
-L20 2 m 0,60 Kg

Codice base Base code	Ottica Optic	Fissaggio Fixing	Colour T (K)	Finitura Finish	Chiusura Closing
--------------------------	-----------------	---------------------	-----------------	--------------------	---------------------

Customizzabile fino a 2m
Customizable up to 2m

LS2 -	O opale / opal	PL	Z 2700K	01	L10
			C 3000K	02	L20
			N 4000K	07	

24Vdc

CE IP20

Caratteristiche illuminotecniche / Lighting specifications

Dimensione Size (mm)	LED Lumen	Product Lumen		Watt	Vdc	Colour T	CRI
		opal	prismatic				
1003	1900	1235	-	16	24	2700	93
	2000	1300	-	16	24	3000	93
	2100	1365	-	16	24	4000	93
2003	3800	2470	-	32	24	2700	93
	4000	2600	-	32	24	3000	93
	4200	2730	-	32	24	4000	93

Driver da ordinare separatamente / Drivers to be ordered separately

07250 Output 24Vdc 75W
On/Off

Controller da ordinare separatamente
Controller to be ordered separately

CT00050 Dimmer 1 ch
DALI2-PUSH-0/1..10V

CT00052 Dimmer 1 ch
PUSH/WIRELESS

Reference configurator

Il codice prodotto si compone mettendo in fila, da sinistra a destra, i dati contenuti nelle colonne a partire da "Codice base".

The product code is created by putting in sequence the data starting from "Base code", from left to right.

es: LS2-OPLC02L20



 **04**

Linee

sospensione

suspended

Design per un'architettura fluida

Design for a fluid architecture

^{ITA} Ideali per chi vuole dare un tocco moderno o futuristico ai propri progetti: perfetti per applicazioni residenziali e hospitality, possono essere inseriti anche all'interno di spazi retail o museali e per alcuni contesti office. L'unico limite è l'immaginazione! Le linee luminose sospese sono perfettamente bilanciate tra cielo e terra, sostenute dai sottili cavi di acciaio che rendono l'installazione leggera ma allo stesso tempo stabile e sicura.

^{EN} Ideal for those who want to give a modern or futuristic touch to their projects: perfect for residential and hospitality applications, they can also fit in retail or museum spaces and some office contexts. The only limit is imagination! The suspended luminous lines flawlessly hover between heaven and earth, supported by thin steel cables that make the installation light but stable and safe.





Ara SP (in alto / above)
Lunae (a sinistra / on the left)

Luminosa linearità per personalizzare spazi e dar vita ad atmosfere uniche

Luminous linearity to customise spaces and create unique atmospheres

^{ITA} Da quasi invisibile a rivelato, 35 crea dettagli nascosti o è il protagonista di un'installazione che lascia a bocca aperta. La sua sottigliezza traccia una linea minima tra dettagli funzionali, elementi grafici e aspetti decorativi utilizzando materiali, colori e luce.

^{EN} From hidden to revealed, 35 can create concealed details or be the centerpiece of a breathtaking installation. Its subtleness draws a thin line between functional details, graphical statements and decorative features using materials, colors, and light.

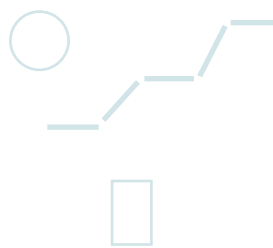

Asseco Headquarter - Bratislava



35 - Sistema lineare sospeso

35 - Suspended linear system

Caratteristiche

Features

^{ITA} Il sistema lineare sospeso Trentacinque (35) svolge tre diverse tipologie di illuminazione: luce indiretta diffusa verso l'alto, luce diretta diffusa verso il basso, e luce d'accento. **35 Linear** è un elemento cilindrico che crea luce diffusa verso l'alto e/o luce diffusa verso il basso. **35 Track** unisce la morbidezza della luce diffusa indiretta tipica del 35 alla massima flessibilità d'uso e performance del binario 48V_{DC}, consentendo una maggiore possibilità di configurazione del sistema luminoso. Grazie a questi elementi modulari, il sistema Trentacinque (35) è facilmente configurabile per progettare l'illuminazione di uno spazio con una totale flessibilità di forme e funzioni.

In fase di installazione è possibile raggruppare gli elementi luminosi del Trentacinque (35) in diversi gruppi o scene, lasciando libertà di scelta di accensioni e di dimmerazione.

Contattaci per i tuoi progetti con Trentacinque

^{EN} 35 suspended linear system has three different types of light: indirect diffused uplight, direct diffused downlight, and accent lighting. **35 Linear** is a cylindrical element that can create diffused uplight and/or diffused downlight. **35 Track** combines diffused uplight, with the maximum flexibility and the extensive performance of the 48V_{DC} track, allowing for greater possibility of configuring the lighting system. Using these modular elements, the 35 system can be configured to shape the light as required, with flexibility in forms and functions.

The Trentacinque (35) can be wired into separate groups, allowing an independent control of the lighting components, and giving designers the freedom to create diverse architectural lighting installations.

Contact us for your projects with Trentacinque.

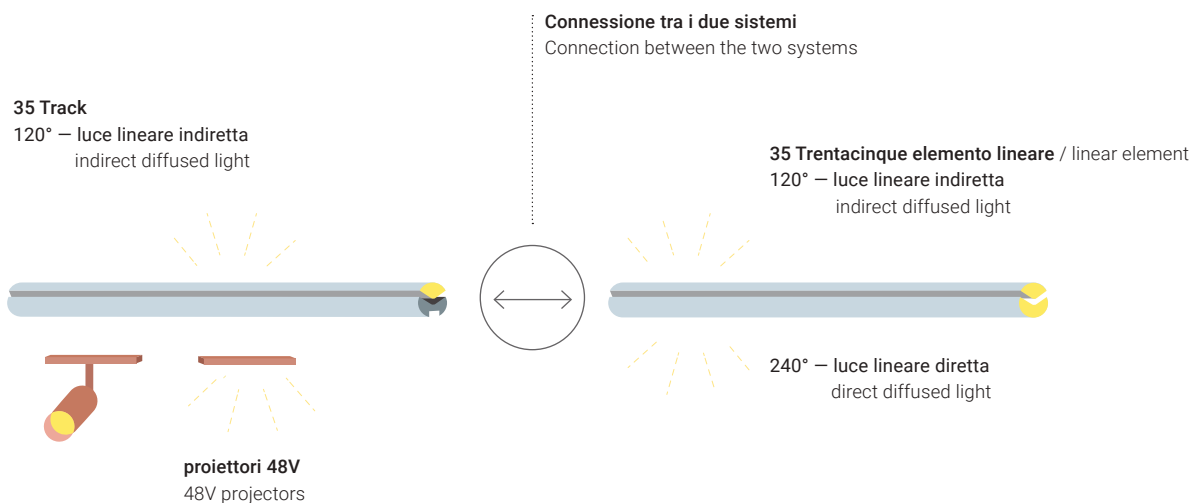



elemento lineare
linear element
(master + continuous)



kit di sospensione
suspension kit



elemento lineare track
track linear element



Miniroller
linea di luce d'accento
accent light line



giunto L
L joint



giunto flessibile
flexible joint



proiettori 48V_{DC}
48V_{DC} spotlights



Linea 48
linea di luce diffusa
diffused light line

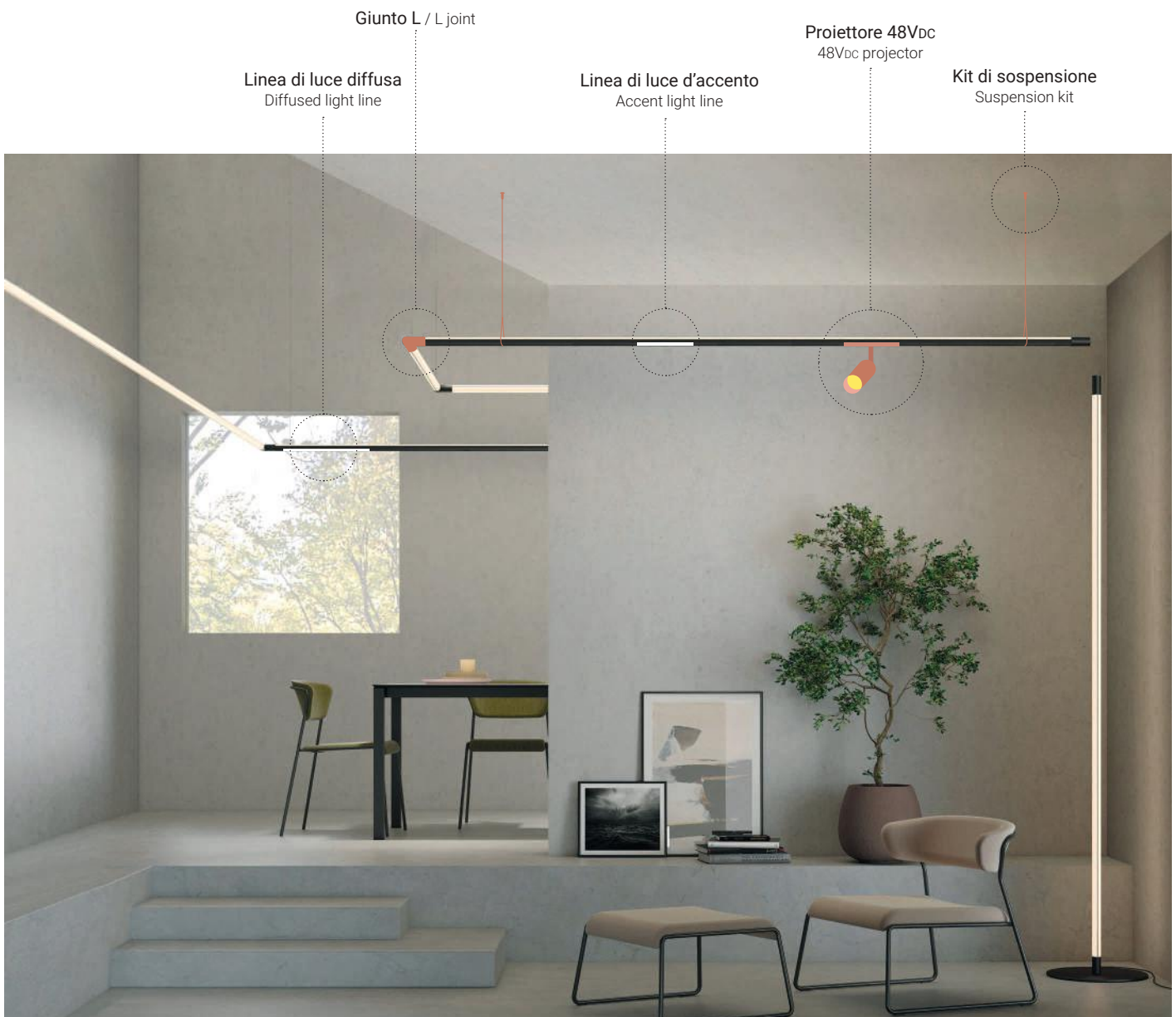

^{ITA} Elemento lineare in alluminio anodizzato con diffusori in policarbonato; giunti di connessione in pressofusione di alluminio verniciato poliester.

^{EN} Linear element in anodized aluminium with diffusers in polycarbonate; connection joints in die-cast aluminium, polyester painted.

Tutti gli elementi lineari permettono la continuità elettrica all'elemento successivo con un giunto lineare integrato.

Every linear element powers the next element through an integrated connection.

Configurazione

Configuration

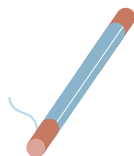

01 primo componente

first component

^{ITA} elemento lineare master:
necessario come primo componente

^{EN} master linear element: compulsory
as first component

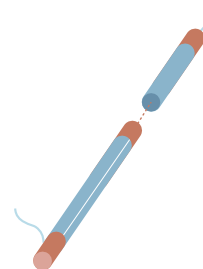

02 secondo componente

second component

^{ITA} elemento lineare continuo
come possibile secondo componente

^{EN} continuous linear element
as possible second component



Schemi di dimmerazione
scaricabili dal sito

Dimming schemes can be
downloaded from the web site

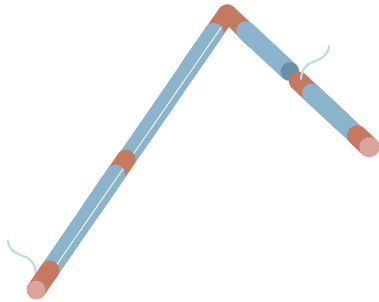

03 componenti successivi nuova alimentazione

continuous components
new power supply

^{ITA} terminati i Watt disponibili dal driver, occorre inserire nuovamente un elemento lineare master

^{EN} once the maximum wattage supplied by the driver is reached, an additional 'first component' is required

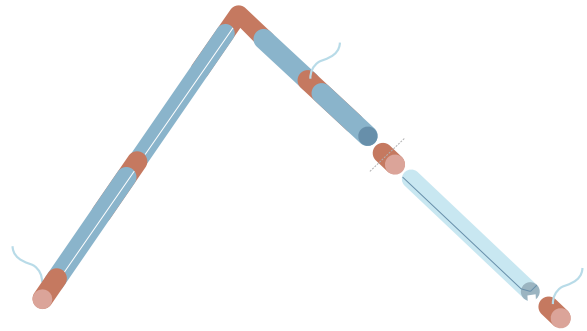

04 integrazione con 35 Track

addition of 35 Track

^{ITA} tramite giunto meccanico dedicato, lineare o a L, è possibile connettere uno o più elementi di 35 Track, da alimentare successivamente

^{EN} through dedicated mechanical linear or L joint, it is possible to connect one or more elements of 35 Track, to be feeded from another point



Il Sistema 35 + 35 Track e Miniroller 48V
35 System+35 Track and Miniroller 48V

Il sistema lineare sospeso 35 è disponibile con due varianti di diffusore

The 35 suspended linear system comes
with two options of diffuser.



Diffusore fumé spento
Smokey diffuser switched off

^{ITA} I diffusori sono accessori in grado di rendere 35 un prodotto ancor più completo. È possibile optare per il diffusore opale, che dà l'impressione di essere bianco quando spento, ma che dona un effetto elegante e fine al prodotto. In alternativa è disponibile anche il diffusore fumé, accattivante quando spento, ma delicato e d'atmosfera quando acceso.

^{EN} Diffusers are accessories capable of making 35 an even more complete product. You can either go for the opal diffuser which looks white when switched off but offers an elegant and delicate effect. Alternatively, the smoked diffuser is also available, attractive when turned off but good looking and atmospheric when turned on.



Diffusore fumé acceso
Smokey diffuser switched on

Finiture

Finishes

^{ITA} I sistemi 35 e 35 Track + 120° sono disponibili nelle finiture bianco o nero e con diffusori opale, fumé oppure nero, combinabili tra loro per adattarsi alle diverse esigenze progettuali.

^{EN} The 35 and 35 Track + 120° systems come as white or black as standard finishes. You can combine opal, smoked or black diffusers to get the most of your lighting project.

La luce si fa arredo

Light becomes decor

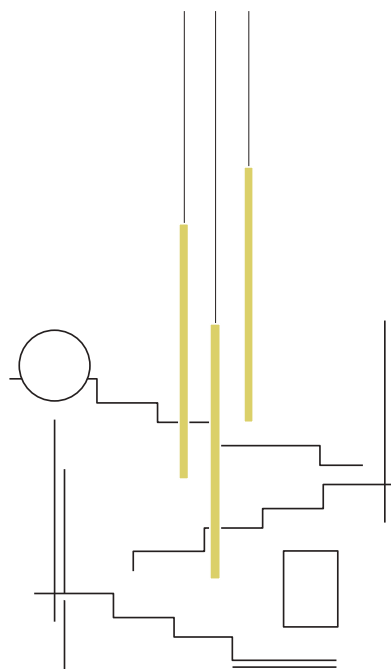

ITA 35 si trasforma in una traccia di luce verticale, per focalizzare l'attenzione su dettagli nascosti e dar vita a profondità spaziali. Pura semplicità caratterizzata da una varietà di CCT e finiture, per adattarsi in modo flessibile e sempre nuovo ai diversi ambienti.

Questa sospensione con rosone è ideale per applicazioni indoor contract, hospitality e residenziali, in ambienti caratterizzati da soffitti in doppia altezza e scenografici.

EN 35 turns into a trace of vertical light, to focus attention on hidden details and create spatial depths. Pure simplicity, characterized by a variety of CCTs and finishes, to adapt with flexibility to different spaces.

This suspended lamp with canopy is ideal for contract, hospitality and residential indoor applications, in spaces featuring double-height spectacular ceilings .

35 Candela, grazie ad un sapiente gioco di equilibri illuminotecnici, dà vita a suggestive atmosfere rispondendo a esigenze funzionali e scenografiche.

35 Candela, thanks to a skillful distribution of balances in the lighting design, brings the space to life, satisfying both functional and scenographic requirements.













04

Linee

sospensione

suspended

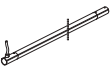
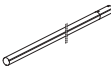
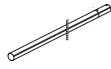

	Products	Pages
	Orion SP	144
	Arrow SP	145
	Ara SP	146
	Dolphin SP	147
	Cassiopea SP	148
	Dorado SP	149
	Lunae	150
	Hula Hoop	151
	35 Master	152
	35 Continuo	153
	35 Continuo OFF	154
	35 Track	155
	35 Candela	156

ORION SP

SOSPENSIONE / SUSPENSION



01 Bianco White 02 Nero Black 07 Oro Gold

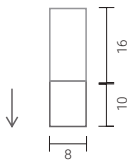

-L10 1 m 0,20 Kg
-L20 2 m 0,40 Kg

Codice base Base code	Ottica Optic	Fissaggio Fixing	Colour T (K)	Finitura Finish	Chiusura Closing
--------------------------	-----------------	---------------------	-----------------	--------------------	---------------------

Customizzabile fino a 4m
Customizable up to 4m

ON -	O opale / opal	SP	Z 2700K	01	L10
			C 3000K	02	L20
			N 4000K	07	

24Vdc

CE IP20

Caratteristiche illuminotecniche / Lighting specifications

Dimensione Size (mm)	LED Lumen	Product Lumen		Watt	Vdc	Colour T	CRI
		opal	prismatic				
1002	1220	915	-	11	24	2700	93
	1280	960	-	11	24	3000	93
	1340	1005	-	11	24	4000	93
2002	2440	1830	-	22	24	2700	93
	2560	1920	-	22	24	3000	93
	2680	2010	-	22	24	4000	93

Driver da ordinare separatamente / Drivers to be ordered separately

07250 Output 24Vdc 75W
On/Off

Controller da ordinare separatamente
Controller to be ordered separately

CT00050 Dimmer 1 ch
DALI2-PUSH-0/1..10V

CT00052 Dimmer 1 ch
PUSH/WIRELESS

Reference configurator

Il codice prodotto si compone mettendo in fila, da sinistra a destra, i dati contenuti nelle colonne a partire da "Codice base".

The product code is created by putting in sequence the data starting from "Base code", from left to right.

es: ON-OSPC02L20



Accessori / accessories

 **Rosone quadrato / Square canopy**
AC00362_00001 Bianco / White
AC00362 Nero / Black
AC00362_00004 Oro / Gold

 **Rosone tondo / Round canopy**
AC00385 Bianco / White
AC00385_00002 Nero / Black
AC00385_00004 Oro / Gold

 **Rosone copricavi / Cable cover canopy**
AC00262 Bianco / White
AC00320 Nero / Black
Ø83 mm

ARROW SP

SOSPENSIONE / SUSPENSION

Sospensione Suspended



01 Bianco White 02 Nero Black 07 Oro Gold

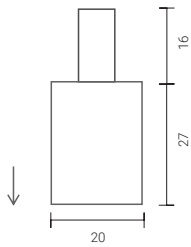

-L10
1 m
0,46 Kg

-L20
2 m
0,92 Kg

-L30
3 m
1,38 Kg

Codice base Ottica Fissaggio Colour Finitura **Chiusura**
Base code Optic Fixing T (K) Finish Closing

Customizzabile fino a 2m
Customizable up to 2m

AW2 -	O opale / opal	SP	Z 2700K	01	L10
			C 3000K	02	L20
			N 4000K	07	L30

24V_{dc}

CE IP20

Caratteristiche illuminotecniche / Lighting specifications

Dimensione Size (mm)	LED Lumen	Product Lumen		Watt	V _{dc}	Colour T	CRI
		opal	prismatic				
1004	1900	1273	-	16	24	2700	93
	2000	1340	-	16	24	3000	93
	2100	1407	-	16	24	4000	93
2004	3800	2546	-	32	24	2700	93
	4000	2680	-	32	24	3000	93
	4200	2814	-	32	24	4000	93
3004	5700	3819	-	48	24	2700	93
	6000	4020	-	48	24	3000	93
	6300	4221	-	48	24	4000	93

Driver da ordinare separatamente / Drivers to be ordered separately

07250 Output 24V_{dc} 75W
On/Off

Controller da ordinare separatamente
Controller to be ordered separately

CT00050 Dimmer 1 ch
DALI2-PUSH-0/1..10V

CT00052 Dimmer 1 ch
PUSH/WIRELESS

Reference configurator

Il codice prodotto si compone mettendo in fila, da sinistra a destra, i dati contenuti nelle colonne a partire da "Codice base".

The product code is created by putting in sequence the data starting from "Base code", from left to right.

es: AW2-OSPZ07L30



Accessori / accessories

 **Rosone quadrato / Square canopy**
AC00362_00001 Bianco / White
AC00362 Nero / Black
AC00362_00004 Oro / Gold

 **Rosone tondo / Round canopy**
AC00385 Bianco / White
AC00385_00002 Nero / Black
AC00385_00004 Oro / Gold

 **Rosone copricavi / Cable cover canopy**
AC00262 Bianco / White
AC00320 Nero / Black
Ø83 mm

ARA SP

SOSPENSIONE / SUSPENSION



01 Bianco White 02 Nero Black 07 Oro Gold

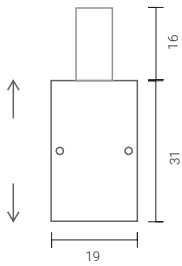

-L10
1 m
0,90 Kg

-L20
2 m
1,80 Kg

-L30
3 m
2,70 Kg

Codice base Ottica Fissaggio Colour Finitura Chiusura
Base code Optic Fixing T (K) Finish Closing

Customizzabile fino a 4m
Customizable up to 4m

ABE - **O** opale / opal **SP** **Z** 2700K **01** **L10**
C 3000K **02** **L20**
N 4000K **07** **L30**

24Vdc

CE IP20

Caratteristiche illuminotecniche / Lighting specifications

Dimensione Size (mm)	LED Lumen	Product Lumen		Watt	Vdc	Colour T	CRI
		opal	prismatic				
1004	1900	1330	-	32	24	2700	93
	2000	1400	-	32	24	3000	93
	2100	1470	-	32	24	4000	93
2004	3800	2660	-	64	24	2700	93
	4000	2800	-	64	24	3000	93
	4200	2940	-	64	24	4000	93
3004	5700	3990	-	96	24	2700	93
	6000	4200	-	96	24	3000	93
	6300	4410	-	96	24	4000	93

Driver da ordinare separatamente / Drivers to be ordered separately

07145 Output 24Vdc 150W
On/Off

Controller da ordinare separatamente
Controller to be ordered separately

CT00050 Dimmer 1 ch
DALI2-PUSH-0/1..10V

CT00052 Dimmer 1 ch
PUSH/WIRELESS

Reference configurator

Il codice prodotto si compone mettendo in fila, da sinistra a destra, i dati contenuti nelle colonne a partire da "Codice base".

The product code is created by putting in sequence the data starting from "Base code", from left to right.

es: ABE-OSPC02L20



Accessori / accessories



Rosone quadrato / Square canopy
AC00362_00001 Bianco / White
AC00362 Nero / Black
AC00362_00004 Oro / Gold



Rosone tondo / Round canopy
AC00385 Bianco / White
AC00385_00002 Nero / Black
AC00385_00004 Oro / Gold



Rosone copricavi / Cable cover canopy
AC00262 Bianco / White
AC00320 Nero / Black
Ø83 mm

DOLPHIN

SOSPENSIONE / SUSPENSION

Sospensione Suspended



01 Bianco White 02 Nero Black 07 Oro Gold

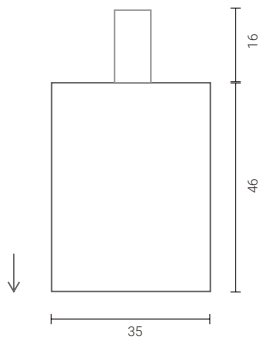

-L10 1 m 1,15 Kg
-L20 2 m 2,30 Kg
-L30 3 m 3,45 Kg

Codice base Base code	Ottica Optic	Fissaggio Fixing	Colour T (K)	Finitura Finish	Dimming Dimming	Chiusura Closing	
Customizzabile fino a 4m Customizable up to 4m							
D02 -	O opale / opal	SP	Z 2700K	01	IO On/Off	L10	
	P prismatico / prismatic		C 3000K	02		DP Dali	L20
			N 4000K	07			L30
24Vdc							

CE IP20

Caratteristiche illuminotecniche / Lighting specifications

Dimensione Size (mm)	LED Lumen	Product Lumen		Watt	V _{ac}	Colour T	CRI
		opal	prismatic				
1004	1900	1330	1520	16	200~240	2700	93
	2000	1400	1600	16	200~240	3000	93
	2100	1470	1680	16	200~240	4000	93
2004	3800	2660	3040	32	200~240	2700	93
	4000	2800	3200	32	200~240	3000	93
	4200	2940	3360	32	200~240	4000	93
3004	5700	3990	4560	48	200~240	2700	93
	6000	4200	4800	48	200~240	3000	93
	6300	4410	5040	48	200~240	4000	93

Reference configurator

Il codice prodotto si compone mettendo in fila, da sinistra a destra, i dati contenuti nelle colonne a partire da "Codice base".

The product code is created by putting in sequence the data starting from "Base code", from left to right.

es: D02-PSPC02L20



Accessori / accessories

 **Rosone quadrato / Square canopy**
AC00362_00001 Bianco / White
AC00362 Nero / Black
AC00362_00004 Oro / Gold

 **Rosone tondo / Round canopy**
AC00385 Bianco / White
AC00385_00002 Nero / Black
AC00385_00004 Oro / Gold

 **Rosone copricavi / Cable cover canopy**
AC00262 Bianco / White
AC00320 Nero / Black
Ø83 mm

CASSIOPEA

SOSPENSIONE / SUSPENSION



01 Bianco White 02 Nero Black 07 Oro Gold

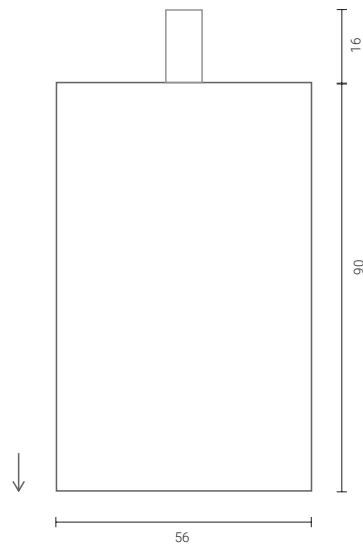

-L10
1 m
3,00 Kg

-L20
2 m
6,00 Kg

-L30
3 m
9,00 Kg

Codice base Base code	Ottica Optic	Fissaggio Fixing	Colour T (K)	Finitura Finish	Dimming Dimming	Chiusura Closing
--------------------------	-----------------	---------------------	-----------------	--------------------	--------------------	---------------------

Alimentatore e centralina interne al profilo. Customizzabile fino a 4m
Driver and control unit inside the profile. Customizable up to 4m

CA2 -	O opale / opal	SP	Z 2700K	01	IO On/Off	L10	
	P prismaticata / prismatic		C 3000K	02		DP Dali	L20
			N 4000K	07			L30

200~240 Vac

CE IP20

Caratteristiche illuminotecniche / Lighting specifications

Dimensione Size (mm)	LED Lumen	Product Lumen		Watt	Vac	Colour T	CRI
		opal	prismatic				
1004	1900	1330	1520	16	200~240	2700	93
	2000	1400	1600	16	200~240	3000	93
	2100	1470	1680	16	200~240	4000	93
2004	3800	2660	3040	32	200~240	2700	93
	4000	2800	3200	32	200~240	3000	93
	4200	2940	3360	32	200~240	4000	93
3004	5700	3990	4560	48	200~240	2700	93
	6000	4200	4800	48	200~240	3000	93
	6300	4410	5040	48	200~240	4000	93

Reference configurator

Il codice prodotto si compone mettendo in fila, da sinistra a destra, i dati contenuti nelle colonne a partire da "Codice base".

The product code is created by putting in sequence the data starting from "Base code", from left to right.

es: CA2-OSPC01DPL20



Accessori / accessories

 **Rosone copricavi** / Cable cover canopy
AC00262 Bianco / White
AC00320 Nero / Black
 Ø83 mm

DORADO SP

SOSPENSIONE / SUSPENSION

Sospensione Suspended



01 Bianco White 02 Nero Black 07 Oro Gold

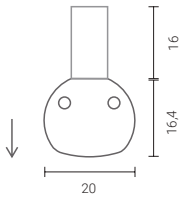

-L10 1 m 0.48 Kg
-L20 2 m 0.96 Kg

Codice base Base code	Ottica Optic	Fissaggio Fixing	Colour T (K)	Finitura Finish	Chiusura Closing
--------------------------	-----------------	---------------------	-----------------	--------------------	---------------------

Profilo orientabile. Customizzabile fino a 4m
Adjustable profile. Customizable up to 4m

DR2 -	O opale / opal	SP	Z 2700K	01	L10
			C 3000K	02	L20
			N 4000K	07	

24Vdc

CE IP20

Caratteristiche illuminotecniche / Lighting specifications

Dimensione Size (mm)	LED Lumen	Product Lumen		Watt	Vdc	Colour T	CRI
		opal	prismatic				
1004	1900	1330	-	16	24	2700	93
	2000	1400	-	16	24	3000	93
	2100	1470	-	16	24	4000	93
2004	3800	2660	-	32	24	2700	93
	4000	2800	-	32	24	3000	93
	4200	2940	-	32	24	4000	93

Driver da ordinare separatamente / Drivers to be ordered separately

07250 Output 24Vdc 75W
On/Off

Controller da ordinare separatamente
Controller to be ordered separately

CT00050 Dimmer 1 ch
DALI2-PUSH-0/1..10V

CT00052 Dimmer 1 ch
PUSH/WIRELESS

Reference configurator

Il codice prodotto si compone mettendo in fila, da sinistra a destra, i dati contenuti nelle colonne a partire da "Codice base".

The product code is created by putting in sequence the data starting from "Base code", from left to right.

es: DR2-OSPC02L20



Accessori / accessories

 **Rosone quadrato** / Square canopy
AC00362_00001 Bianco / White
AC00362 Nero / Black
AC00362_00004 Oro / Gold

 **Rosone tondo** / Round canopy
AC00385 Bianco / White
AC00385_00002 Nero / Black
AC00385_00004 Oro / Gold

 **Rosone copricavi** / Cable cover canopy
AC00262 Bianco / White
AC00320 Nero / Black
Ø83 mm

LUNAE

SOSPENSIONE / SUSPENSION

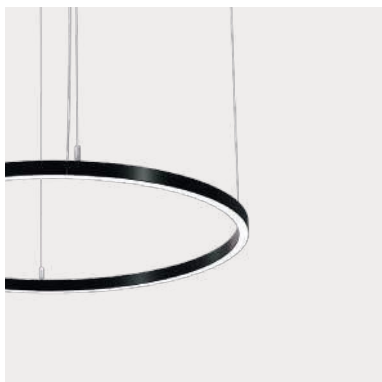

01 Bianco White 02 Nero Black 07 Oro Gold

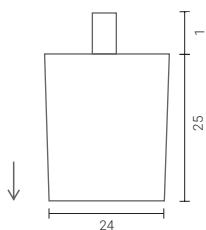

-D062
Ø620
0,80 Kg

-D090
Ø900
1,20 Kg

Codice base Base code	Ottica Optic	Fissaggio Fixing	Colour T (K)	Finitura Finish	Chiusura Closing
--------------------------	-----------------	---------------------	-----------------	--------------------	---------------------

Variante da comporre a seconda delle proprie necessità
Variant to compose according to your needs.

LU2 -	O opale / opal	SP	Z 2700K	01	D062
			C 3000K	02	D090
			N 4000K	07	

700 mA

CE IP20

Caratteristiche illuminotecniche / Lighting specifications

Dimensione Size (mm)	LED Lumen	Product Lumen		Watt	mA	Colour T	CRI
		opal	prismatic				
Ø620	3840	2688	-	25	700	2700	80
	3990	2793	-	25	700	3000	80
	4204	2943	-	25	700	4000	80
Ø900	4800	3360	-	32	700	2700	80
	4992	3494	-	32	700	3000	80
	5256	3679	-	32	700	4000	80

Driver da ordinare separatamente / Drivers to be ordered separately

09254 Output 700mA 0-40W
On/Off/DALI/PUSH

Reference configurator

Il codice prodotto si compone mettendo in fila, da sinistra a destra, i dati contenuti nelle colonne a partire da "Codice base".

The product code is created by putting in sequence the data starting from "Base code", from left to right.

es: LU2-OSPZ01D062

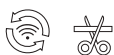

Accessori / accessories



Rosone quadrato / Square canopy
AC00362_00001 Bianco / White
AC00362 Nero / Black
AC00362_00004 Oro / Gold



Rosone tondo / Round canopy
AC00385 Bianco / White
AC00385_00002 Nero / Black
AC00385_00004 Oro / Gold



Rosone copricavi / Cable cover canopy
AC00262 Bianco / White
AC00320 Nero / Black
Ø83 mm

HULA HOOP

SOSPENSIONE / SUSPENSION

Sospensione Suspended



01 **Bianco**
White

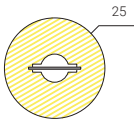

-D069 **-D090**
Ø699 Ø904
 1,50 Kg 2,00 Kg

Codice base Base code	Ottica Optic	Fissaggio Fixing	Colour T (K)	Finitura Finish	Chiusura Closing
--------------------------	-----------------	---------------------	-----------------	--------------------	---------------------

Variante da comporre a seconda delle proprie necessità
Variant to compose according to your needs.

HH2 -	O opale / opal	SP	Z 2700K	01	D069
			C 3000K		D090
			N 4000K		

24Vdc

IP20

Caratteristiche illuminotecniche / Lighting specifications

Dimensione Size (mm)	LED Lumen	Product Lumen		Watt	Vdc	Colour T	CRI
		opal	prismatic				
Ø699	8278	4139	-	67,5	24	2700	93
	8714	4357	-	67,5	24	3000	93
	9150	4575	-	67,5	24	4000	93
Ø904	10721	5361	-	88	24	2700	93
	11285	5643	-	88	24	3000	93
	11850	5925	-	88	24	4000	93

Driver da ordinare separatamente / Drivers to be ordered separately

07255 Output 24Vdc 100W
On/Off

Controller da ordinare separatamente
Controller to be ordered separately

CT00050 Dimmer 1 ch
DALI2-PUSH-0/1..10V

CT00052 Dimmer 1 ch
PUSH/WIRELESS

Reference configurator

Il codice prodotto si compone mettendo in fila, da sinistra a destra, i dati contenuti nelle colonne a partire da "Codice base".

The product code is created by putting in sequence the data starting from "Base code", from left to right.

es: HH2-OSPN1D090



Accessori / accessories



Rosone quadrato / Square canopy
AC00362_00001 Bianco / White
AC00362 Nero / Black
AC00362_00004 Oro / Gold



Rosone tondo / Round canopy
AC00385 Bianco / White
AC00385_00002 Nero / Black
AC00385_00004 Oro / Gold



Rosone copricavi / Cable cover canopy
AC00262 Bianco / White
AC00320 Nero / Black
Ø83 mm

35 Trentacinque

ELEMENTO LINEARE MASTER / MASTER LINEAR ELEMENT



12 62 Nero anodizzato + diffusore opale
Anodized black + opal diffuser

04 62 Bianco + diffusore opale
White + opal diffuser

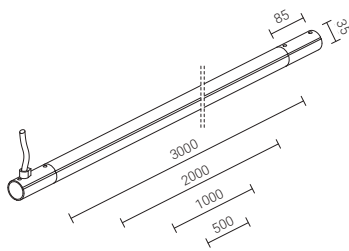

Reference configurator

Il codice prodotto si compone mettendo in fila, da sinistra a destra, i dati contenuti nelle colonne a partire da "Codice base".

The product code is created by putting in sequence the data starting from "Base code", from left to right.

es: 457-230209A-1062

Codice base Base code	Lunghezza Length (mm)	CRI	Colour T (K)	Finitura Finish
--------------------------	--------------------------	-----	-----------------	--------------------

Con due giunti lineari e diffusore in policarbonato opale.
Doppia accensione 120° + 240° / With two straight joints and diffuser in opal polycarbonate. Double switch 120° + 240°

457-230	05 500 mm	9 >90	C 2700K	-0462
	10 1000 mm		B 3000K	-1262
	20 2000 mm		A 4000K	
	30 3000 mm			

48V_{DC}

CE IP20

Per accessori vedi pag. 154. Per trasformatori e dimmer (da ordinare separatamente) vedi pag. 157
For accessories see page 154. For transformers and dimmers (to be ordered separately) see page 157

Codice base Base code	Lunghezza Length (mm)	Colour T (K)	Finitura Finish
--------------------------	--------------------------	-----------------	--------------------

Con due giunti lineari e diffusore in policarbonato opale.
Singola accensione 360° - RGBW / With two straight joints and diffuser in opal polycarbonate. Single switch 360° - RGBW

477-130	05 500 mm	EE RGBW	-0462
	10 1000 mm		-1262
	20 2000 mm		
	30 3000 mm		

Caratteristiche illuminotecniche / Lighting specifications

Lunghezza Length (mm)	Watt	LED Lumen	Product Lumen	Colour T (K)	CRI
500 mm	5 + 10	525 + 1050	293 + 586	2700	90
	5 + 10	550 + 1100	307 + 614	3000	90
	5 + 10	575 + 1150	322 + 644	4000	90
	15	1161	649	RGBW 2700	90
1000 mm	10 + 20	1050 + 2100	586 + 1172	2700	90
	10 + 20	1100 + 2200	614 + 1228	3000	90
	10 + 20	1150 + 2300	644 + 1288	4000	90
	30	2322	1300	RGBW 2700	90
2000 mm	20 + 40	2100 + 4200	1172 + 2344	2700	90
	20 + 40	2200 + 4400	1228 + 2456	3000	90
	20 + 40	2300 + 4600	1288 + 2576	4000	90
	60	4644	2601	RGBW 2700	90
3000 mm	30 + 60	3150 + 6300	1758 + 3517	2700	90
	30 + 60	3300 + 6600	1842 + 3684	3000	90
	30 + 60	3450 + 6900	1932 + 3864	4000	90
	90	6966	3891	RGBW 2700	90

35 Trentacinque

ELEMENTO LINEARE CONTINUO / CONTINUOUS LINEAR ELEMENT

Sospensione Suspended



12 62 Nero anodizzato + diffusore opale
Anodized black + opal diffuser

04 62 Bianco + diffusore opale
White + opal diffuser

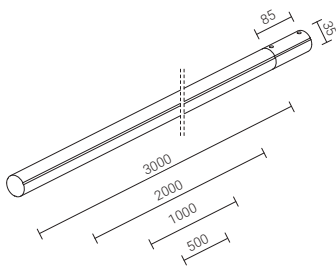

Reference configurator

Il codice prodotto si compone mettendo in fila, da sinistra a destra, i dati contenuti nelle colonne a partire da "Codice base".

The product code is created by putting in sequence the data starting from "Base code", from left to right.

es: 478-13030EE-0462

Codice base Lunghezza CRI Colour Finitura
Base code Length (mm) T (K) Finish

Con un giunto lineare e diffusore in policarbonato opale.
Doppia accensione 120° + 240° / With one straight joint and diffuser in opal polycarbonate. Double switch 120° + 240°

Codice base	Lunghezza	CRI	Colour	Finitura
458-230	05 500 mm	9 >90	C 2700K	-0462
	10 1000 mm		B 3000K	-1262
	20 2000 mm		A 4000K	
	30 3000 mm			

48V_{DC}

CE IP20

Per accessori vedi pag. 154. Per trasformatori e dimmer (da ordinare separatamente) vedi pag. 157
For accessories see page 154. For transformers and dimmers (to be ordered separately) see page 157

Codice base Lunghezza Colour Finitura
Base code Length (mm) T (K) Finish

Con un giunto lineare e diffusore in policarbonato opale.
Singola accensione 360° - RGBW / With one straight joint and diffuser in opal polycarbonate. Single switch 360° - RGBW

Codice base	Lunghezza	Colour	Finitura
478-130	05 500 mm	EE RGBW	-0462
	10 1000 mm		-1262
	20 2000 mm		
	30 3000 mm		

Caratteristiche illuminotecniche / Lighting specifications

Lunghezza	Watt	LED	Product	Colour	CRI
Length (mm)		Lumen	Lumen	T (K)	
500 mm	5 + 10	525 + 1050	293 + 586	2700	90
	5 + 10	550 + 1100	307 + 614	3000	90
	5 + 10	575 + 1150	322 + 644	4000	90
	15	1161	649	RGBW 2700	90
1000 mm	10 + 20	1050 + 2100	586 + 1172	2700	90
	10 + 20	1100 + 2200	614 + 1228	3000	90
	10 + 20	1150 + 2300	644 + 1288	4000	90
	30	2322	1300	RGBW 2700	90
2000 mm	20 + 40	2100 + 4200	1172 + 2344	2700	90
	20 + 40	2200 + 4400	1228 + 2456	3000	90
	20 + 40	2301 + 4600	1288 + 2576	4000	90
	60	4644	2601	RGBW 2700	90
3000 mm	30 + 60	3150 + 6300	1758 + 3517	2700	90
	30 + 60	3300 + 6600	1842 + 3684	3000	90
	30 + 60	3450 + 6900	1932 + 3864	4000	90
	90	6966	3891	RGBW 2700	90

35 Trentacinque

ELEMENTO LINEARE CONTINUO OFF / CONTINUOUS LINEAR ELEMENT OFF



Codice base Base code	Lunghezza Length (mm)	Finitura Finish
--------------------------	--------------------------	--------------------

Per continuità con giunto lineare e cover in policarbonato nero
For continuity with one straight joint and cover in black polycarbonate

458-000	10 1000mm	-0462
	20 2000mm	-1262

12 62 Nero anodizzato + diffusore opale
Anodized black + opal diffuser

04 62 Bianco + diffusore opale
White + opal diffuser

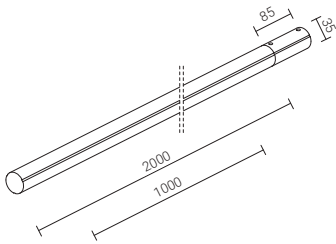

Cover fumé / Smoked diffuser

Quando Trentacinque (35) è spento, la cover fumé mantiene l'effetto di finitura nera dando l'impressione che l'alluminio e il diffusore siano un unico elemento continuo.

The smoked diffuser enables a continuous effect of black finish when the light is off, giving the impression that the metal parts and the diffuser are one and the same part.

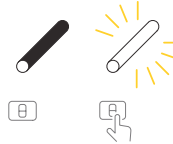

Accessori / Accessories

46-11 (500 mm)
Diffusore fumé
Smoked diffuser

46-15 (1000 mm)
Diffusore fumé
Smoked diffuser

46-17 (2000 mm)
Diffusore fumé
Smoked diffuser

46-09 (3000 mm)
Diffusore fumé
Smoked diffuser

Accessori su richiesta / Accessories on demand

46-01
Giunto L
L joint

21 16

46-02
Giunto flessibile
Flexible joint

21 16

46-18
Giunto a L con cavo alimentatore
L joint with power cable

21 16

46-05-00 (3000 mm)
Kit di sospensione
Suspension kit

46-13 (3 pz / 3 pcs)
Kit di montaggio parete/soffitto
Kit for wall/ceiling mounting

21 16

46-12
Rosone
Canopy

21 16



Codice base Base code	Lunghezza Length (mm)	Finitura Finish
--------------------------	--------------------------	--------------------

Per continuità con giunto lineare e cover in policarbonato nero
For continuity with one straight joint and cover in black polycarbonate

6447-	20 2000mm	-0462
	30 3000mm	-1262

48Vdc

12 62 Nero anodizzato + diffusore opale
Anodized black + opal diffuser

04 62 Bianco + diffusore opale
White + opal diffuser



Equipaggiabile con proiettori 48Vdc, vedi pag. 224. Per trasformatori e dimmer (da ordinare separatamente) vedi pag. 157 / It can be equipped with 48Vdc track lights, see page 224. For transformers and dimmers (to be ordered separately) see page 157.

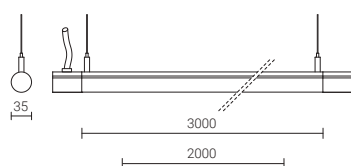

Accessori 35 Track / 35 Track accessories



6490-10
Alimentazione destra
Right live-end

31 30



6490-11
Alimentazione sinistra
Left live-end

31 30



6491-00
Alimentazione centrale
Central connector

31 30



6492-00
Giunto lineare elettrico
Straight electric joint

31 30



6493-10
Giunto lineare meccanico
Straight mechanical joint

31 30



6494-10
Giunto a L interno
Inside L joint

31 30



6494-11
Giunto a L esterno
Outside L joint

31 30

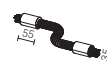

6495-00
Giunto flessibile
Flexible joint

31 30



6496-00 (3000 mm)
Kit di sospensione con anello,
cavo e bloccacavo / Suspension
kit with ring, wire and wire lock

21 16



6497-00 (1000 mm)
Kit di sospensione con anello
rigido e tige rigida / Suspension
kit with stiff ring and stiff rod

21 16



6498-00 (1000 mm)
Copertura binario
Track cover

31 30



6499-00
Chiusura
Dead end

31 30



6500-00
Giunto meccanico di
collegamento 35/35 Track
Mechanical connection joint
35/35 Track

21 16



6501-00
Giunto meccanico di
collegamento a L 35/35 Track
Mechanical connection L joint
35/35 Track

21 16



93-WB948-2520A-30 (3000 mm)
Kit striped cablata 48V
Wired striped kit 48V
25W/m 2585lm/m 3000K

31 30



93-WC948-2520A-30 (3000 mm)
Kit striped cablata 48V
Wired striped kit 48V
25W/m 2450lm/m 2700K

31 30



6502-10
Alimentazione destra e giunto
elettrico di collegamento 35/35 Track
Right live-end and electrical
connection joint 35/35 Track

31 30



6502-11
Alimentazione sinistra e giunto
elettrico di collegamento 35/35 Track
Left live-end and electrical
connection joint 35/35 Track

31 30



46-17 (2000 mm)
Diffusore fumé
Smoked diffuser



46-09 (3000 mm)
Diffusore fumé
Smoked diffuser

35 Candela



- 12 62** Nero anodizzato + diffusore opale
Anodized black + opal diffuser
- 04 62** Bianco + diffusore opale
White + opal diffuser
- 10 62** Oro satinato + diffusore opale
Satin gold + opal diffuser
- 18 62** Nickel spazzolato + diffusore opale
Brushed nickel + opal diffuser

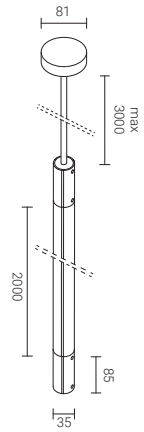

Codice base Base code	Lunghezza Length (mm)	CRI	Colour T (K)	Finitura Finish
--------------------------	--------------------------	-----	-----------------	--------------------

Con rosone, diffusore in policarbonato opale e cavo di sospensione
3000mm / With canopy, diffuser in opal polycarbonate and 3000mm
suspension cable

447-130	20 2000 mm	9 >90	C 2700K	-0462
			B 3000K	-1062
				-1262
				-1862

48V_{DC}



Per trasformatori (da ordinare separatamente) vedi pagina accanto
For transformers (to be ordered separately) see the next page

Caratteristiche illuminotecniche / Lighting specifications

Lunghezza Length (mm)	Watt	LED Lumen	Product Lumen	Colour T (K)	CRI
2000 mm	60	6300	3515	2700	90
	60	6600	3683	3000	90

Cover fumé / Smoked diffuser

Quando Trentacinque (35) è spento, la cover fumé mantiene l'effetto di finitura nera dando l'impressione che l'alluminio e il diffusore siano un unico elemento continuo.

The smoked diffuser enables a continuous effect of black finish when the light is off, giving the impression that the metal parts and the diffuser are one and the same part.

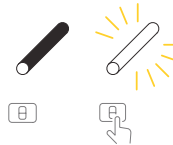

Accessori / Accessories

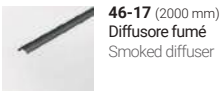

46-17 (2000 mm)
Diffusore fumé
Smoked diffuser

35 Trentacinque

Sospensione Suspended

ELEMENTO LINEARE MASTER / MASTER LINEAR ELEMENT
ELEMENTO LINEARE CONTINUO / CONTINUOUS LINEAR ELEMENT

Trasformatori da ordinare separatamente
Transformers should be ordered separately

81-09000	48V _{DC} Trasformatore PWM per uso remoto - 100W PWM transformer for remote use - 100W
81-09001	48V _{DC} Trasformatore PWM per uso remoto - 200W PWM transformer for remote use - 200W
81-04085	48V _{DC} Trasformatore regolabile wireless Bluetooth Wireless Bluetooth dimmable transformer

Dimmer da ordinare separatamente
Dimmers should be ordered separately

81-90089	Dimmer Casambi Bluetooth 4 canali / 4 channels
81-90123	Dimmer PWM

35 Track

Trasformatori da ordinare separatamente
Transformers should be ordered separately

81-09000	48V _{DC} Trasformatore PWM per uso remoto - 100W PWM transformer for remote use - 100W
81-09001	48V _{DC} Trasformatore PWM per uso remoto - 200W PWM transformer for remote use - 200W
81-90122	48V _{DC} Trasformatore PWM per uso remoto - 300W PWM transformer for remote use - 300W
6465-03-31	48V _{DC} Trasformatore DALI per uso remoto - 150W DALI transformer for remote use - 150W
81-04085	48V _{DC} Trasformatore regolabile wireless Bluetooth Wireless Bluetooth dimmable transformer

Dimmer e controller da ordinare separatamente
Dimmer e controllers should be ordered separately

81-90089	Dimmer Casambi Bluetooth 4 canali / 4 channels
81-90123	Dimmer PWM
81-90124	Dimmer DALI
81-90128	Controller DALI Bluetooth

35 Candela

Trasformatori da ordinare separatamente
Transformers should be ordered separately

81-09000	48V _{DC} Trasformatore PWM per uso remoto - 100W PWM transformer for remote use - 100W
81-04085	48V _{DC} Trasformatore regolabile wireless Bluetooth Wireless Bluetooth dimmable transformer



Schemi di dimmerazione
scaricabili dal sito
Dimming schemes can be
downloaded from the web site



Real Light Striped

Real Light LED Strips

^{ITA} Le StripLED della linea Real Light sono in grado di offrire un ritorno cromatico pressochè naturale restituendo nel modo più fedele possibile i colori all'occhio umano, grazie alle loro elevate prestazioni. Questa tipologia di Strip è progettata per adeguarsi il più possibile al concetto della Human Centric Light ovvero un insieme di soluzioni e sistemi di illuminazione che combinano effetti visivi, biologici ed emozionali della luce, influenzando il benessere e le prestazioni individuali delle persone. Questo porta ad un naturale miglioramento dell'umore, della produttività e della concentrazione oltre a regolarizzare il ciclo circadiano.

L'efficacia della luce diffusa dalle StripLED trova applicazione in diversi campi; dai musei dove regola il controllo delle problematiche relative alla fotosensibilità delle opere illuminate, oltre a favorire la corretta percezione delle opere, passando agli ospedali dove lo spettro di luce viene sviluppato per contesti sensibili in modo da contribuire ad una ottimale utilizzazione di aree luminose a diverso cromaticismo.

Un'altra applicazione dalla quale sono emersi grandi risultati, è l'ambito retail, un'elevata qualità della luce infatti, può valorizzare i colori e la nitidezza degli oggetti illuminati.

^{EN} StripLEDs in the Real Light line offer an almost natural colour rendition that is as true to the human eye as possible, thanks to their high performance. This type of strip is designed to conform as closely as possible to the concept of Human Centric Light, i.e. a set of lighting solutions and systems that combine the visual, biological and emotional effects of light, influencing people's individual well-being and performance.

This leads to a natural improvement in mood, productivity and concentration as well as regularising the circadian cycle. The effectiveness of StripLED diffused light finds application in a variety of areas; from museums where it regulates photosensitivity issues of illuminated works, as well as facilitating the correct perception of the works, to hospitals where the light spectrum is developed for sensitive contexts to contribute to the optimal use of lighting areas with different chromaticity. Another application from which great results have emerged is the retail sector, where high light quality enhances the colours and sharpness of illuminated objects.

STRIP LED 196 LED/m 20W



5000x8x2 mm



35,71 mm



Profili e striped

Profiles and LED Strips

Codice Code	Watt/mt	Lumen/mt	LED/mt	Colour T (K)	CRI		TM30		
					Ra	R9	Rf	Rg	
Driver da ordinare separatamente / Driver should be ordered separately									
06438	20	2108	196	2700	98	95	98	96	
06439	20	2204	196	3000	98	95	98	96	
06447	20	2396	196	4000	98	95	98	96	
06448	20	2396	196	5800	98	95	98	96	

Striped ideale per a natural rendering of light
LED Strip ideal for a natural rendering of light

CE IP20 24Vdc

STRIP LED 196 LED/m 28W



5000x8x2 mm



35,71 mm



Codice Code	Watt/mt	Lumen/mt	LED/mt	Colour T (K)	CRI		TM30		
					Ra	R9	Rf	Rg	
Driver da ordinare separatamente / Driver should be ordered separately									
06449	28	2958	196	2700	98	95	98	96	
06454	28	3093	196	3000	98	95	98	96	
06455	28	3362	196	4000	98	95	98	96	
06456	28	3362	196	5800	98	95	98	96	

Striped ideale per a natural rendering of light
LED Strip ideal for a natural rendering of light

CE IP20 24Vdc



05

Linee esterni

outdoor

Protagonisti nella notte

Protagonists in the night

^{ITA} Si adattano a qualsiasi esigenza di progetto e dialogano con l'ambiente esterno, mettendo in primo piano la luce ed enfatizzando materiali, architettura e natura. Danno vita agli ambienti con giochi di luce, ombre e scenografie suggestive, connotando di personalità le facciate, il terrazzo o i percorsi. Recessati, calpestabili o orientabili per applicazioni con staffa, racchiudono luce LED di qualità in dimensioni ridotte (massimo 35 millimetri).

^{EN} They adapt to any project requirement and dialogue with the external environment, putting light in the foreground and emphasizing materials, architecture and nature. They give life to the rooms with plays of light, shadows and evocative scenographies, giving the facades, the terrace or the paths with personality. Recessed, walkable or adjustable for applications with brackets, they enclose quality LED light in small dimensions (maximum 35 mm).



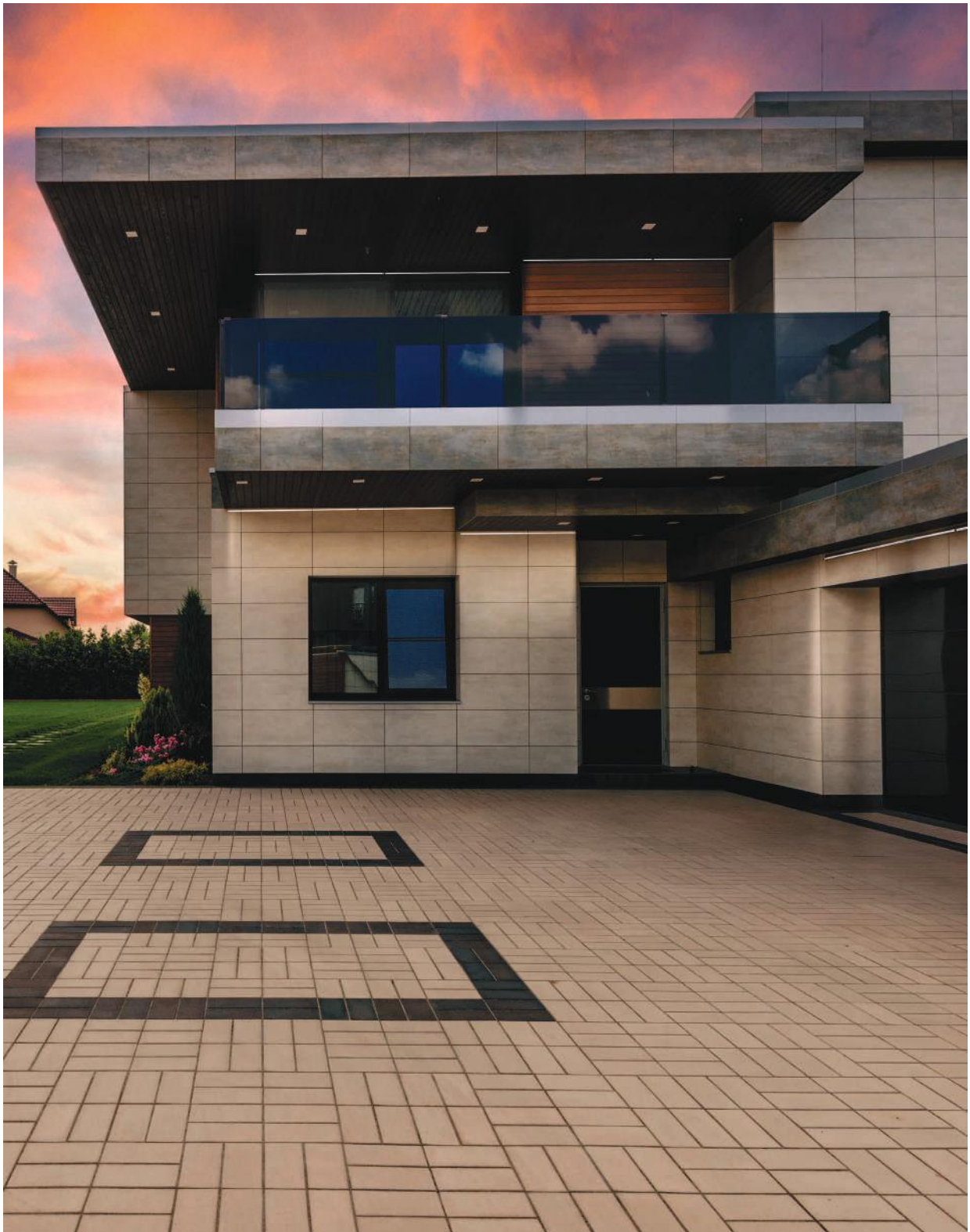

Hydra

05

Linee

esterni

outdoor



	Products	Pages
	Scorpion OUT	164
	Capricorn	165
	Hydra	166
	Hydra optics	167

SCORPION OUT OUTDOOR



00 Alluminio
Alluminium

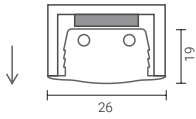

-L10 1 m	-L20 2 m	-L30 3 m
 0,80 Kg	 1,60 Kg	 2,40 Kg

Codice base Base code	Ottica Optic	Fissaggio Fixing	Colour T (K)	Finitura Finish	Chiusura Closing
---------------------------------	-----------------	---------------------	-----------------	--------------------	----------------------------

Customizzabile fino a 4m
Customizable up to 4m

SC2 -	O opale / opal	CF	Z 2700K	00	L10
			C 3000K		L20
			N 4000K		L30

24Vdc

CE  IP68

Caratteristiche illuminotecniche / Lighting specifications

Dimensione Size (mm)	LED Lumen	Product Lumen		Watt	Vdc	Colour T	CRI
		opal	prismatic				
1004	1900	1330	-	16	24	2700	93
	2000	1400	-	16	24	3000	93
	2100	1470	-	16	24	4000	93
2004	3800	2660	-	32	24	2700	93
	4000	2800	-	32	24	3000	93
	4200	2940	-	32	24	4000	93
3004	5700	3990	-	48	24	2700	93
	6000	4200	-	48	24	3000	93
	6300	4410	-	48	24	4000	93

Driver da ordinare separatamente / Drivers to be ordered separately

07250 Output 24Vdc 75W
On/Off

Controller da ordinare separatamente
Controller to be ordered separately

CT00050 Dimmer 1 ch
DALI2-PUSH-0/1..10V

CT00052 Dimmer 1 ch
PUSH/WIRELESS

Reference configurator

Il codice prodotto si compone mettendo in fila, da sinistra a destra, i dati contenuti nelle colonne a partire da "Codice base".

The product code is created by putting in sequence the data starting from "Base code", from left to right.

es: SC2-OCFC00L20



CAPRICORN OUTDOOR

Esterni Outdoor



00 Alluminio
Alluminium

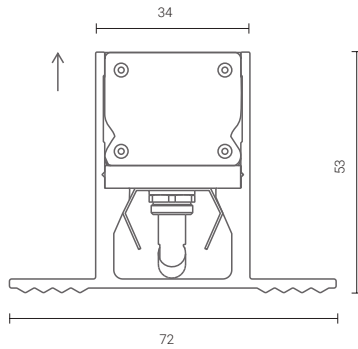

-L10 1 m 2,10 Kg
-L20 2 m 4,20 Kg

Codice base Base code	Ottica Optic	Fissaggio Fixing	Colour T (K)	Finitura Finish	Chiusura Closing
--------------------------	-----------------	---------------------	-----------------	--------------------	---------------------

Calpestabile. Customizzabile fino a 4m
Walkable. Customizable up to 4m

CN2 -	CF	Z 2700K	00	L10
		C 3000K		L20
		N 4000K		

24Vdc

CE IP68

Caratteristiche illuminotecniche / Lighting specifications

Dimensione Size (mm)	LED Lumen	Product Lumen		Watt	Vdc	Colour T	CRI
		opal	prismatic				
1004	1700	1020	-	15	24	2700	85
	1800	1080	-	15	24	3000	85
	1900	1140	-	15	24	4000	85
2004	3400	2040	-	30	24	2700	85
	3600	2160	-	30	24	3000	85
	3800	2280	-	30	24	4000	85

Driver da ordinare separatamente / Drivers to be ordered separately

07250 Output 24Vdc 75W
On/Off

Controller da ordinare separatamente
Controller to be ordered separately

CT00050 Dimmer 1 ch
DALI2-PUSH-0/1..10V

CT00052 Dimmer 1 ch
PUSH/WIRELESS

Reference configurator

Il codice prodotto si compone mettendo in fila, da sinistra a destra, i dati contenuti nelle colonne a partire da "Codice base".

The product code is created by putting in sequence the data starting from "Base code", from left to right.

es: CN2-CFC00L20



HYDRA OUTDOOR

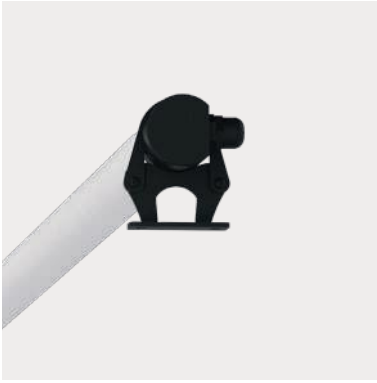

00 Alluminio
Aluminium

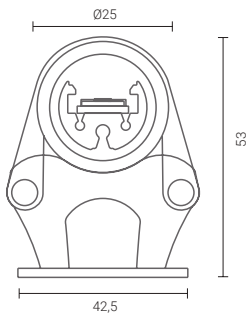

-L06	-L12	-L18
0,606 m	1,206 m	1,806 m
0,70 Kg	1,40 Kg	2,10 Kg

Codice base Base code	Ottica Optic	Fissaggio Fixing	Colour T (K)	Finitura Finish	Chiusura Closing
--------------------------	-----------------	---------------------	-----------------	--------------------	---------------------

Variante da comporre a seconda delle proprie necessità
Variant to compose according to your needs

HY -	O opale / opal	PL	Z 2700K	00	L06
			C 3000K		L12
			N 4000K		L18

24Vdc

CE IP65

Caratteristiche illuminotecniche / Lighting specifications

Dimensione Size (mm)	LED Lumen	Product Lumen		Watt	Vdc	Colour T	CRI
		opal	prismatic				
606	1017	712	-	8,6	24	2700	93
	1070	749	-	8,6	24	3000	93
	1124	786	-	8,6	24	4000	93
1206	2170	1519	-	18,3	24	2700	93
	2284	1599	-	18,3	24	3000	93
	2398	1679	-	18,3	24	4000	93
1806	3257	2280	-	27,4	24	2700	93
	3428	2400	-	27,4	24	3000	93
	3599	2520	-	27,4	24	4000	93

Driver da ordinare separatamente / Drivers to be ordered separately

07250 Output 24Vdc 75W
On/Off

Controller da ordinare separatamente
Controller to be ordered separately

CT00050 Dimmer 1 ch
DALI2-PUSH-0/1..10V

CT00052 Dimmer 1 ch
PUSH/WIRELESS

Reference configurator

Il codice prodotto si compone mettendo in fila, da sinistra a destra, i dati contenuti nelle colonne a partire da "Codice base".

The product code is created by putting in sequence the data starting from "Base code", from left to right.

es: HY-OPLZ07L12





00 **Alluminio**
Alluminium

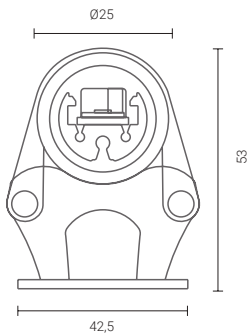

-L06 0,606 m  0,75 Kg	-L12 1,206 m  1,50 Kg	-L18 1,806 m  2,25 Kg
---	--	--

Codice base Base code	Ottica Optic	Fissaggio Fixing	Colour T (K)	Finitura Finish	Chiusura Closing
---------------------------------	------------------------	----------------------------	------------------------	---------------------------	----------------------------

Variante da comporre a seconda delle proprie necessità
Variant to compose according to your needs

HY -	1 15°	PL	Z 2700K	00	L06
	2 25°		C 3000K		L12
	4 40°		N 4000K		L18
	J 18x48°				

24Vdc

CE  IP65

Caratteristiche illuminotecniche / Lighting specifications

Dimensione Size (mm)	LED Lumen	Product Lumen		Watt	Vdc	Colour T	CRI
		opal	prismatic				
606	912	803	-	6	24	2700	83
	978	861	-	6	24	3000	83
	990	871	-	6	24	4000	83
1206	1824	1605	-	12	24	2700	83
	1956	1721	-	12	24	3000	83
	1980	1742	-	12	24	4000	83
1806	2736	2408	-	18	24	2700	83
	2934	2582	-	18	24	3000	83
	2970	2614	-	18	24	4000	83

Driver da ordinare separatamente / Drivers to be ordered separately

07250 Output 24Vdc 75W
On/Off

Controller da ordinare separatamente
Controller to be ordered separately

CT00050 Dimmer 1 ch
DALI2-PUSH-0/1..10V

CT00052 Dimmer 1 ch
PUSH/WIRELESS

Reference configurator

Il codice prodotto si compone mettendo in fila, da sinistra a destra, i dati contenuti nelle colonne a partire da "Codice base".

The product code is created by putting in sequence the data starting from "Base code", from left to right.

es: HY-2PLC02L12





04

Linee

super custom

NEON TUBE

L'unico limite è la fantasia

A picture is worth a thousand words

^{ITA} Estruso di silicone di alta qualità, flessibile e modellabile a seconda del progetto.

Neon Tube permette di modellare la luce e disegnare figure morbide nello spazio, grazie a originali segni grafici e a diverse modalità di applicazione.

Prodotto custom da realizzare secondo specifiche.

^{EN} High-quality extruded silicone, flexible and moldable, according to the project.

Neon Tube allows you to model light and draw soft figures in space, thanks to original graphic signs and different application methods.

Custom product to be realized according to specifications.





Neon tube

Il gioco delle forme: la luce diventa sinuosa

The game of shapes: light becomes sinuous



Applicazioni

Applications

Infinite geometrie di luce, essenziali o più complesse, da collocare a parete o a soffitto, grazie ai numerosi accessori.

Contattaci per ulteriori informazioni per il tuo progetto!

Infinite geometries of light, essential or more complex, to be placed on the wall or ceiling, thanks to the numerous accessories.
Contact us for more information about your project!

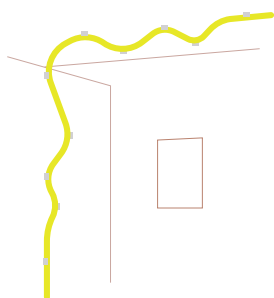

01

Applicazione a soffitto e parete

Horizontal and vertical ceiling installation

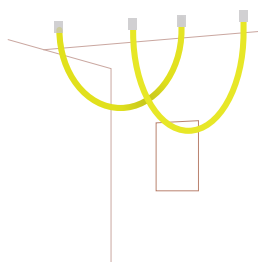

02

Doppia installazione a soffitto

Vertical ceiling-double installation

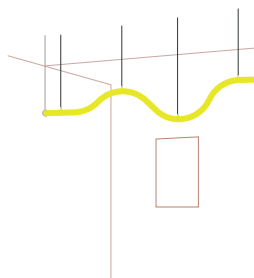

03

Installazione creativa sospesa

Creative vertical suspended installation

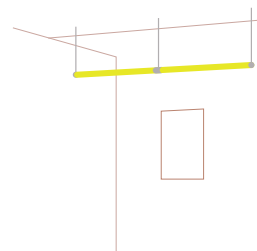

04

Installazione sospesa

Horizontal suspended installation

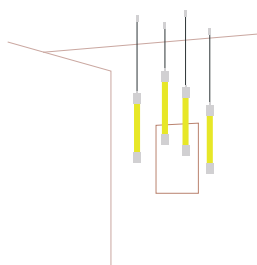

05

Applicazione sospesa verticale

Suspended vertical installation

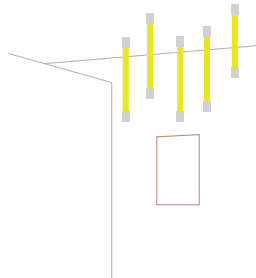

06

Installazione a plafone

Ceiling installation

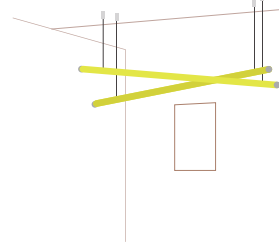

07

Installazione creativa sospesa lineare

Creative vertical linear suspended installation

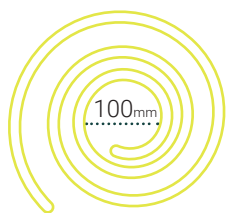

Il raggio minimo è 50mm e l'angolo minimo è 45mm.

The minimum radius is 50mm and the minimum angle is 45mm .

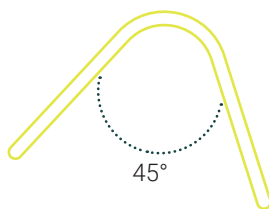

Bobina da 5mt. Il diametro di piega minimo è di 100mm.

5m/Reel, The minimum bending diameter is 100mm.

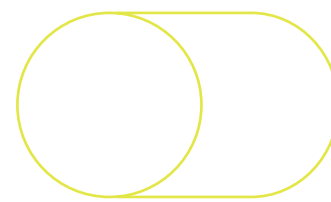

Ø 25mm
(size 1:1)

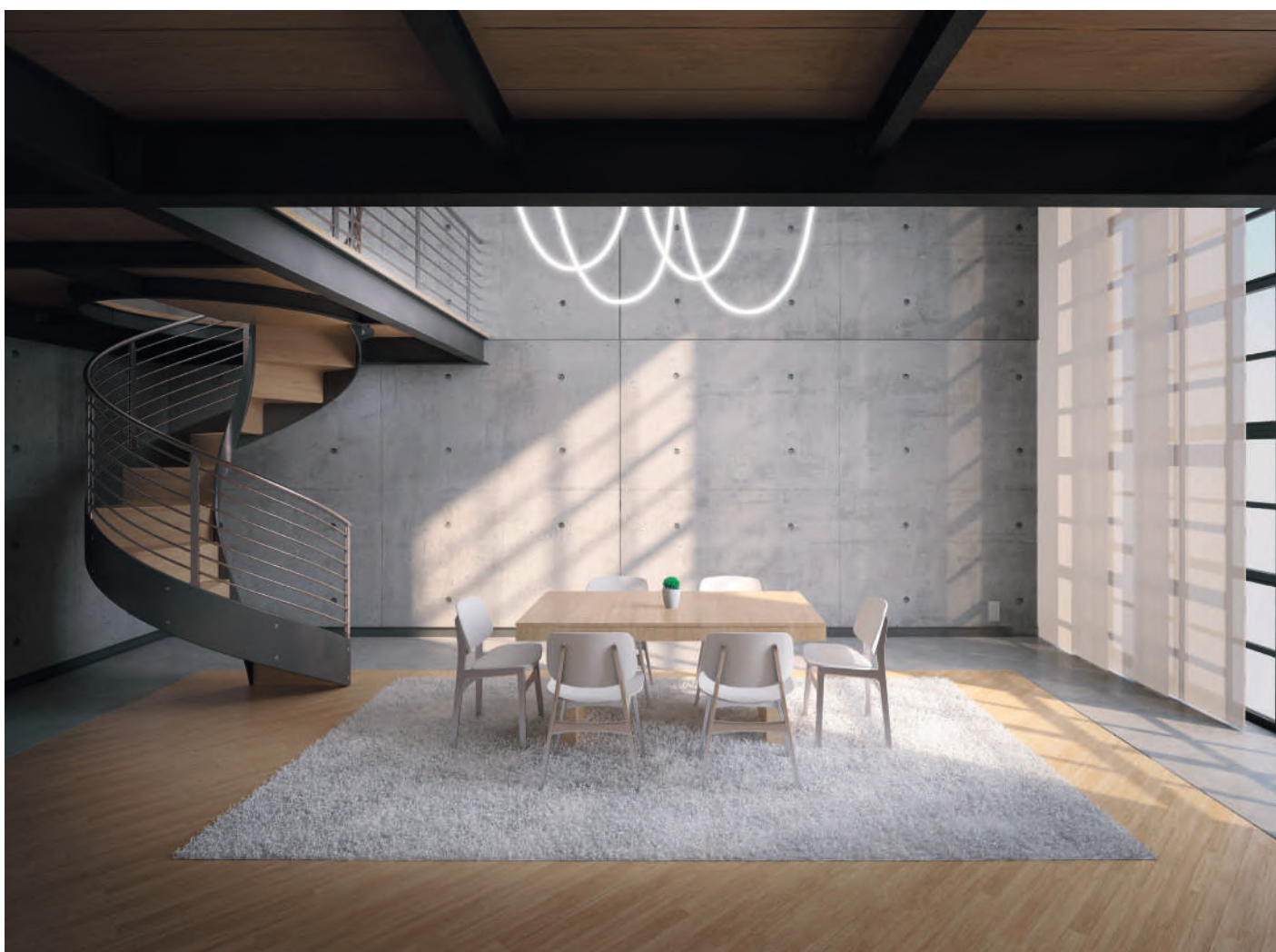

ITA Una luce continua e confortevole, che grazie a moduli base e accessori, permette di costruire forme e linee, in installazione singola o a luce multipla.

EN A continuous and comfortable light that allows you to build shapes and lines in single or multiple light installations, thanks to basic modules and accessories.

Punti

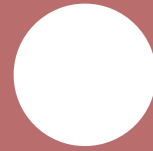

Points

*“Il punto geometrico è un ente invisibile.
Esso dev’essere definito anche un ente
immateriale.*

*Dal punto di vista materiale il punto equivale
allo zero. In questo zero sono però nascoste
varie proprietà “umane”. Ai nostri occhi
questo punto zero - il punto geometrico -
è associato alla massima concisione, al
massimo riserbo, che però parla.
Così il punto geometrico diviene l’unione
suprema di silenzio e parole”*

*“The Point is an immaterial and invisible entity.
It is the symbol of the not-being, which, once it is
materialized, is equivalent to zero. Since it is the most
concise form of expression (“in relation to the greatest
possible brevity”), such an element is the essence of
silence, indeed it is obvious to believe that it does not
produce any sound. Temporally, the Point is attributable to
an instant.”*

V. Kandinskij



La luce è in movimento

Light is moving

^{ITA} Piccolo proiettore da incasso caratterizzato da una massima flessibilità di utilizzo. Il corpo illuminante può essere estratto dalla cornice in diverse posizioni. Nanoperfetto UP è altamente flessibile grazie alla sua rotazione e inclinazione.

^{EN} Small, recessed spotlight featuring a maximum flexibility in use. Lighting body can be pulled out from the bezel in different positions. Nanoperfetto UP is highly flexible thanks to its rotation and inclination.



^{ITA} Grazie alle dimensioni ridotte gli incassi Ivela sono apparecchi impercettibili, ma performanti. Invisibili agli occhi, ma incredibilmente presenti negli ambienti dove vengono inseriti, grazie alla loro luce puntuale e morbida. Sono disponibili con dimensioni e forme differenti, per una massima libertà di progettazione.

^{EN} Thanks to their small size, Ivela downlights are imperceptible but performing devices. They are almost invisible to the eyes but incredibly present in the spaces where they are, thanks to their punctual and soft light. They are available in different sizes and shapes for maximum design freedom.



^{ITA} Gli incassi si nascondono per illuminare la scena. Fori e cilindri di ridotte dimensioni liberano un fascio luminoso, direzionato dove necessario. In un continuo dialogo di presenza-assenza, parla il linguaggio dell'interior e dell'exterior con la stessa disinvoltura.

^{EN} The downlights become invisible to illuminate the scene. Miniaturised cut outs and cylinders direct the light beam; directed where necessary. The blending of indoors and outdoors is performed easily, creating a continuous dialogue between these formerly separate states.

La luce si rivela nei punti giusti

Reveling light in the right places





^{ITA} Minirooler-IN, incasso con 5 o 15 lenti in PMMA: la luce è al servizio dello spazio, a sottolineare forme, linee e funzioni. Mix perfetto tra design e funzionalità, offre proporzioni piacevoli insieme ad un'estetica contemporanea, ideale per soluzioni di interior design che prevedono minimo impatto visivo e controllo dell'abbagliamento.



^{EN} Miniroller-IN, downlight with 5 or 15 PMMA lenses: light is at service of the space, to emphasize forms, lines, and functions. A perfect mix of design and functionality, it offers pleasant proportions together with a contemporary aesthetic, ideal for all interior design solutions that require minimal visual impact and glare control.





Private residence - Torino
JRK Design
Microperfetto Large LKM

Eleganti combinazioni di atmosfere

Elegant combinations of atmospheres

^{ITA} Apparecchi versatili per applicazioni che danno vita a geometrie di luce e volumi nello spazio. Grazie ad accessori ottici intercambiabili, sono in grado di generare luce d'ambiente o d'accento illuminando gli ambienti interni con stile ed eleganza. Il design rigoroso consente applicazioni in qualsiasi tipologia di contesto indoor, armonizzando stile e funzionalità. Alcuni proiettori possono essere installati direttamente su soffitto o parete, altri invece prevedono un'installazione recessata.

^{EN} Versatile light fittings for surface mounted applications, that generate luminous geometries and volumes in the space. Using replaceable optical accessories, these fittings can both be used for general or accent lighting in any interior context combining functionality and elegant design. The rigorous design allows applications in any interior applications, harmonising style and functionality. Some spotlights can be mounted directly on the ceiling or on the wall, others should be installed as recessed fittings.



La luce è il nostro linguaggio

Light is our language

^{ITA} La luce gioca un ruolo chiave nella nostra percezione della realtà. E' per questo che l'illuminazione riveste una funzione fondamentale nel modo in cui viviamo lo spazio: essa diventa un elemento intangibile, che modifica la relazione con gli oggetti che ci circondano.

Con precisione ed eleganza, i Punti aggiungono valore allo spazio, grazie ad una luce che combini gusto estetico e funzionalità.

^{EN} Light is the protagonist in our perception of reality.

And this is why lighting plays a fundamental role in how we experience space: it becomes an intangible tool which modifies the relationship with the objects around us. With precision and elegance, points add value to the rooms thanks to a light that combines aesthetic taste and functionality.



Velodrom CC store - Barcelona
(Photo: Mario Wurzbürger / Lights: Difusiona)



01

Punti

incasso e semi-incasso

downlights and semi-recessed lights

Protagonisti discreti: l'essenziale invisibile

Discreet protagonists: the invisible essential

^{ITA} Il controsoffitto ospita il corpo degli apparecchi celandone la presenza. Quando sono spenti diventano incredibilmente discreti, mentre quando sono accesi se ne avverte l'esistenza in funzione del fascio luminoso.

Gli incassi diffondono luce generale o d'accento, ma sempre ad alto rendimento luminoso. Esprimono valori di luminanza contenuti e livelli di abbagliamento estremamente bassi, grazie a ottiche arretrate e a un'ampia gamma di accessori.

^{EN} The false ceiling holds the body of the fittings, hiding their presence. When they are turned off, they become incredibly discreet.

When they are turned on, they show themselves through the light beam.

The downlights spread general or accent light, keeping high luminous efficiency. The low luminance is combined with extremely low glare levels, thanks to the deeply recessed optics and a wide range of accessories.





Puzzle Bar – Hamburg (Lighting Design: Notholt Lighting Design)
Perfetto-IN 90 Dim to Warm

Soluzioni per il controllo della luce, a portata di mano

Solutions for lighting control, at your fingertips

^{ITA} La tecnologia Dim to Warm consente di gestire la temperatura di colore degli apparecchi, ottenendo variazioni graduali delle tonalità calde della luce, da 2700K a 1800K, attraverso la regolazione dell'intensità luminosa. La resa cromatica rimane costante a qualunque livello di regolazione luminosa. Con il diminuire dell'intensità luminosa, la luce diventerà di tonalità più calda. Grazie a questa tecnologia si possono creare infinite atmosfere luminose, ricreando il piacevole calore di una lampada ad incandescenza, ma con bassi consumi e migliori prestazioni tipiche dei LED. Dim to Warm consente una maggiore scelta in termini di uniformità progettuale e di design. Disponibile anche su apparecchi con lenti a fascio stretto, per creare effetti di luce drammatica in contesti hospitality e residenziali. Dim to Warm richiede l'utilizzo di sistemi di controllo 1-10V o DALI.

^{EN} Dim to Warm technology allows control of color temperature through the regulation of the luminous intensity, providing smooth variations of warm light tones, from 2700K to 1800K. As the luminous intensity of the light source goes down, the light becomes warmer, mimicking the natural warmth of an incandescent lamp, although with the low power consumption and better performance of LED. The color rendering remains constant, independent from the level of dimming. Dim to Warm technology allows a wider choice in terms of project and design uniformity. Available for luminaires with small beam lenses, to get dramatic light effects in hospitality and residential spaces. Dim to Warm requires the use of 1-10V or DALI control systems.



Cerca l'icona accanto ai codici per scoprire i nostri prodotti con tecnologia Dim to Warm.
Look for this icon near the codes and discover our fittings with Dim to Warm technology.

Features

Dim to warm
Dimming curve

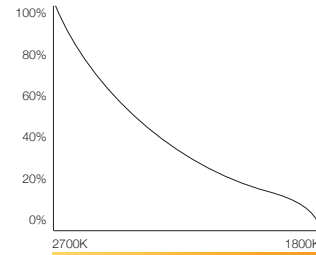

Effetto luminoso naturale / Natural lighting effect
Illuminazione di alta qualità / High quality light
Mantenimento della resa cromatica / Consistency of colour rendering
Semplicità di utilizzo / User friendly



Dimming 10% – 1800K



Dimming 50% – 2200K

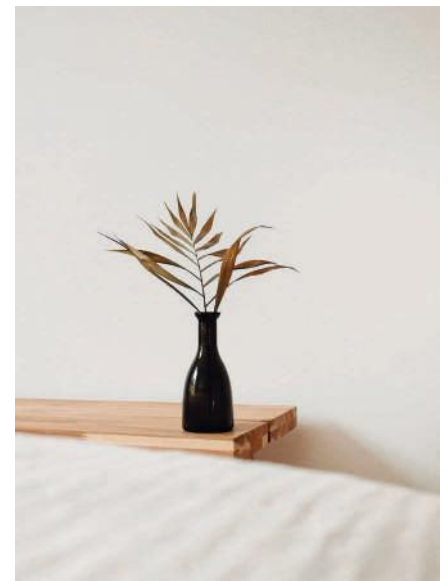

Dimming 100% – 2700K



Perfetto-IN 70



^{ITA} Gli incassi sono progettati per sorgenti LED di ultima generazione e sono disponibili con diverse temperature di colore. Equipaggiati con ottiche per differenti fasci di luce, in unione a dispositivi ottici per un elevato comfort visivo. Sono previste versioni fisse, orientabili o wall-washer, per una moltitudine di effetti di luce differenti.

^{EN} The downlights feature the latest LED sources and are available with different color temperatures. They provide numerous optics for numerous light beams and optical devices for a high visual comfort. Fixed, adjustable, or wall washer versions are available for a multitude of different light effects.



ITA Perfetto-IN 70 Wall Washer si integra negli ambienti in modo morbido ed elegante: la cornice sottilissima consente l'installazione in maniera pressochè invisibile nel controsoffitto.

EN Perfetto-IN 70 Wall Washer integrates into spaces in a soft and elegant way: its very thin trim allows an almost invisible installation in the false ceiling.





Minirooler Foil (1:1 size)

Un nuovo orizzonte nel panorama della luce

A new horizon in the lighting landscape

^{ITA} Minirooler Foil rappresenta un nuovo concetto di intendere la natura visiva e funzionale di un apparecchio luce da incasso, un vero e proprio strumento ottico capace di integrarsi e svelarsi nell'architettura indirizzando e orientando il fascio di luce sul suo asse. All'occorrenza l'apparecchio si spegne automaticamente quando posto in posizione chiusa di massima integrazione con il piano di incasso, poi svelandosi aprendo ed orientando il proprio fascio luminoso.

Minirooler Foil dialoga con il contesto in cui si inserisce, proponendosi nella sua variabilità di presenza visiva, come elemento integrato minimale e mimetico nel contesto o presenza identitaria che caratterizza le superfici e i luoghi in cui viene inserito.

^{EN} Minirooler Foil represents a new concept of understanding the visual and functional nature of a recessed fixture: a real optical instrument capable of integrating and revealing itself in the architecture by directing and orienting the light beam on its axis. The fixture switches off automatically when placed in the closed flush position for maximum integration with the recessed surface, then reveals itself by opening and directing its light beam. Minirooler Foil dialogues with the context, proposing itself in its variability of visual presence as an integrated minimal and mimetic element. In the context of identity presence, that characterizes the surfaces and places where it finds itself.

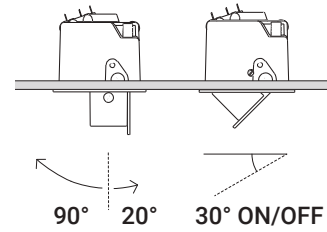

Minirooler Foil si propone, integrandosi, nei casi in cui risulta utile conformare nel tempo la variabilità e direzionabilità delle emissioni luminose; si predispone in maniera mirata a diversi e nuovi scenari nella gestione e riconfigurazione delle aree e spazi da illuminare esaltando o limitando il focus luminoso ove necessario.

Minirooler Foil becomes one with the surface whenever it has to conform to the variability and directionality of light emissions over time; it evolves in a targeted manner for different and new scenarios in the management and reconfiguration of the spaces, enhancing or restraining the luminous focus where necessary.



“Una luce, un apparecchio che appare e scompare, si apre e si chiude, focalizzando, con un movimento naturale, l'emissione. Un nuovo orizzonte nelle prestazioni della luce”

“A light, a device that appears and disappears, opens and closes, focusing, with a natural movement, the emission. A new horizon in light performance”

Alessandro Pedretti

Minirooler Foil è modello di design depositato.
Design: Alessandro Pedretti.

Minirooler Foil is a registered design model. Design:
Alessandro Pedretti.



Enfatizza i dettagli

Accentuate the details

Foil Track dà risalto a spazi espositivi e architettonici dove l'orientabilità del fascio diventa strategia e opportunità di valorizzazione dell'ambiente e degli oggetti da illuminare in esso contenuti.

Binario 48V da incasso con aletta per poterlo chiudere quando non utilizzato e diventare un tutt'uno con la superficie (soffitto / parete / pavimento).

Un apparecchio capace di rendersi protagonista negli spazi dove la giusta luce svolge un ruolo chiave nella qualità e confort ambientale, ponendosi su un nuovo traguardo di versatilità e performance degli apparecchi luminosi da incasso.

^{EN} Foil Track gives prominence to exhibition and architectural spaces where the adjustability of the beam becomes a strategy and opportunity to enhance the environment and the objects it contains.

Recessed 48V track with a flap that can close it when not in use and become one with the surface (ceiling / wall / floor).

A luminaire capable of taking centre stage in spaces where the right light plays a fundamental role in environmental quality and comfort, setting itself on a new goal of versatility and performance for recessed luminaires.



Foil Track è in attesa di deposito come modello di design. Design: Alessandro Pedretti.

Foil Track is registration pending as a design model.
Designer: Alessandro Pedretti.



Accoglie le luci a binario 48V della collezione Punti pag. 224 ed è disponibile con la nuovissima finitura in primer nero per poter personalizzare al massimo la colorazione del prodotto uniformandola alla finitura della parete.

It houses the 48V track lights of the Punti collection on page 224.
It is available with the brand new black primer finishing for customizing the product's colour as much as possible, uniforming it to the finish of the wall.

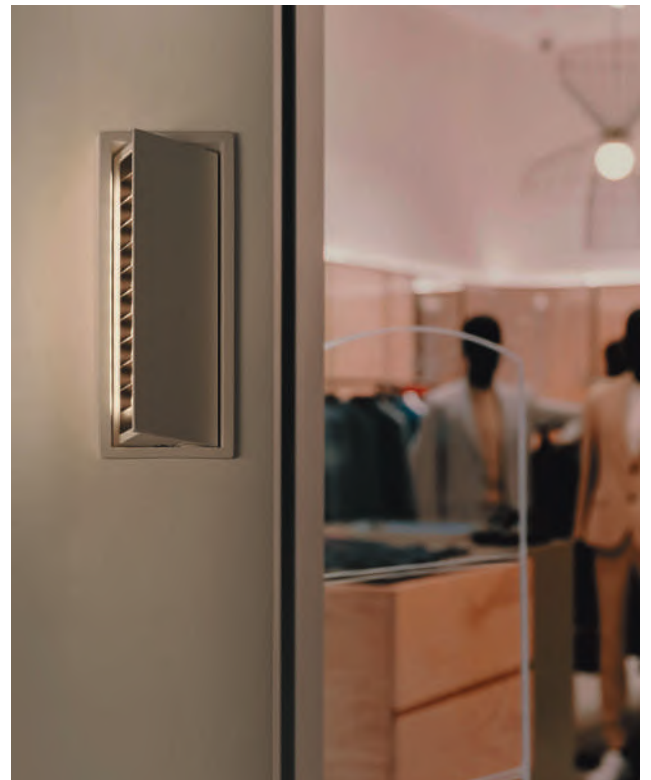

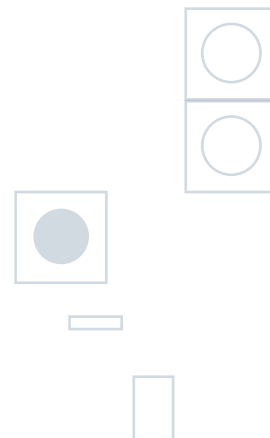

Luce flessibile, dove serve

Flexible light, where needed

^{ITA} Kardan-TL è ideale per ambienti espositivi e ovunque siano richieste luci d'accento, come vetrine, musei, gallerie d'arte. Caratterizzato da una o due fonti luminose orientabili e indipendenti fra loro, senza cornice di finitura è facilmente integrabile in ogni tipologia di arredo grazie alle sue linee essenziali e all'ampia gamma di accessori ottici a corredo.

^{EN} Kardan-TL is ideal for exhibition environments and wherever accent lighting is required, such as shop windows, museums, and art galleries. Characterized by one or two adjustable and independent light sources, without a finishing frame, it can be easily integrated into any architecture thanks to its essential lines and the wide range of optical accessories supplied.



Private residence – Milano (Interior & Lighting design: SLAM Architects)



^{ITA} Microperfetto-R e Microperfetto Cupcake grazie alla forma cilindrica che li accomuna sono perfettamente integrabili in ogni ambiente e contesto. La finitura custom dona ai prodotti maggior carattere e originalità.

^{EN} Microperfetto-R and Microperfetto Cupcake, thanks to the cylindrical shape they have in common, can be perfectly integrated into any environment and context. The custom finish gives the products a modern character and originality.

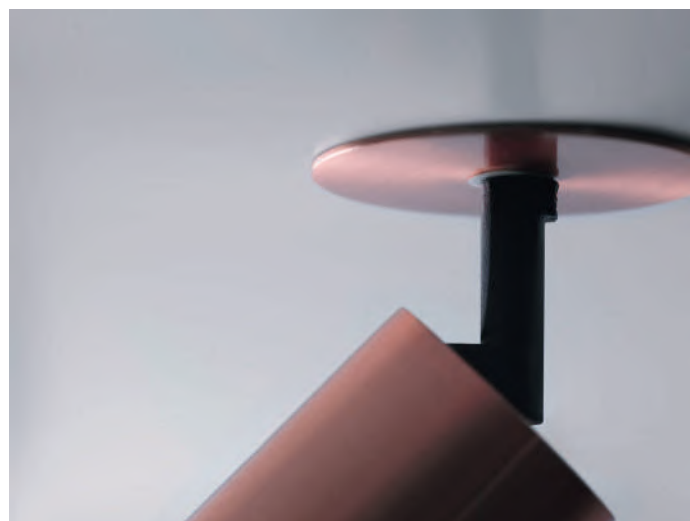

Dettaglio di snodo e rosone del Nanoperfetto-R, in finitura custom.

Detail of joint and canopy of Nanoperfetto-R, with a custom finish.



Silversea - Silver Dawn

01

Punti

incasso e semi-incasso

downlights and semi-recessed lights

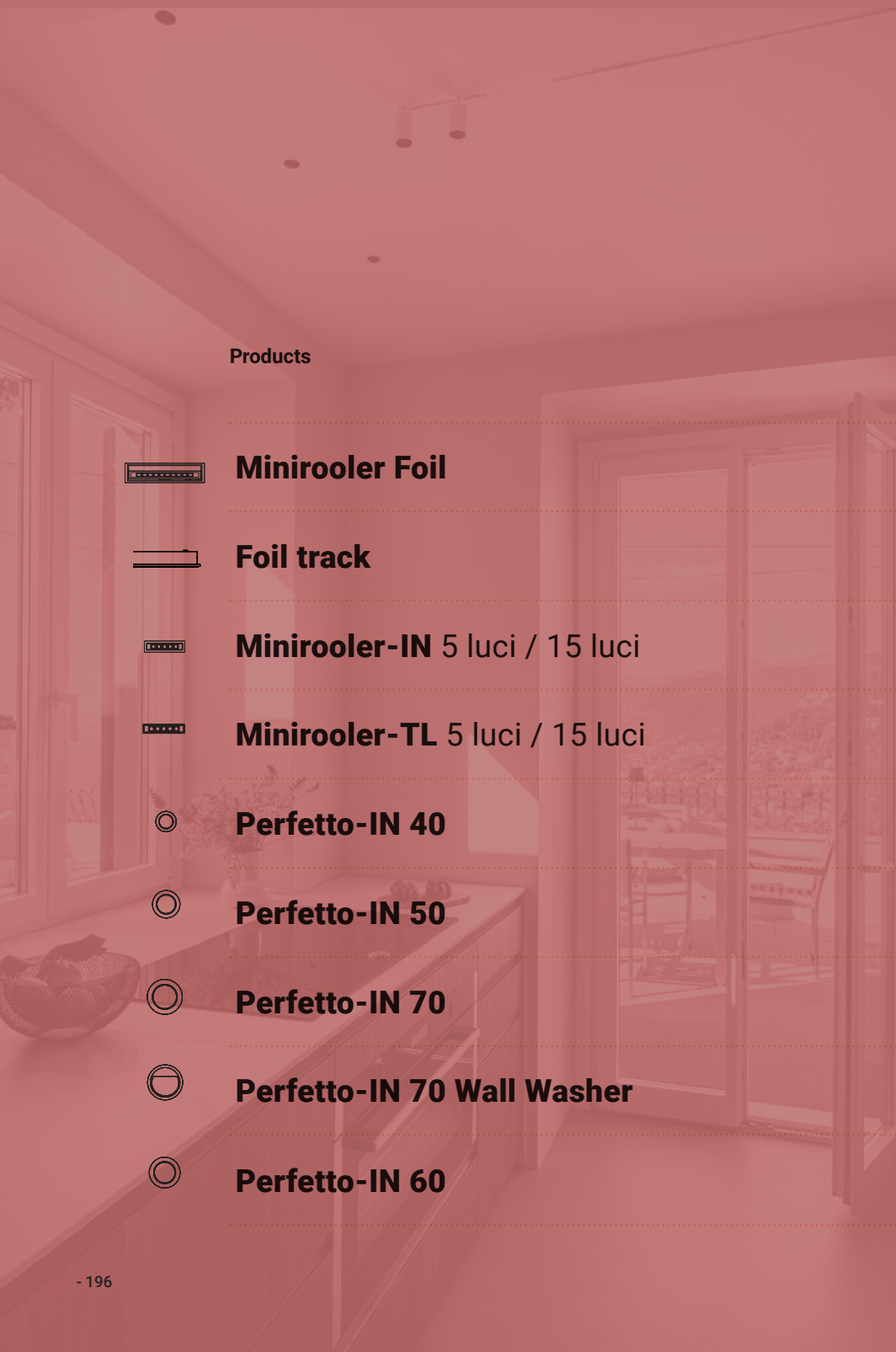

Products

Pages



Miniroller Foil

198



Foil track

199



Miniroller-IN 5 luci / 15 luci

200



Miniroller-TL 5 luci / 15 luci

202



Perfetto-IN 40

204



Perfetto-IN 50

204



Perfetto-IN 70

205

















Perfetto-IN 70 Wall Washer

206

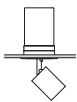

Perfetto-IN 60

207

	Products	Pages
	Perfetto-IN 80	208
	Perfetto-IN 90	210
	RA 7	212
	RA 8 Soft Dixit LED	212
	RA 11 Soft Dixit LED	213
	Pafo	214
	Iside	216
	Chloè	217
	Kardan-IN 1 luce / 2 luci	218
	Kardan-TL 1 luce / 2 luci	219
	Nanoperfetto UP	220
	Nanoperfetto-R	221
	Microperfetto Large-R	222
	Microperfetto Large-R ZOOM	222
	Microperfetto Cupcake	223

MINIROOLER FOIL



21 Bianco mat / Mat white 16 Nero / Black 0Z Nero primer / Black primer

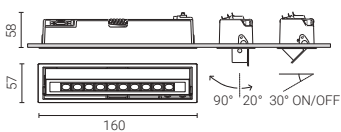

h 58 mm 156x52 mm 0,3 Kg

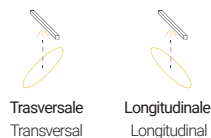

Codice base Base code	Colour T (K)	Fascio Beam	No driver	Finitura Finish
--------------------------	-----------------	----------------	-----------	--------------------

Oscillante, con 10 microlenti in PMMA - fonte luminosa a scomparsa
Tilttable, with 10 PMMA microlenses - vanishing light source

278-019	C 2700K	Z 12°	N	-16
	B 3000K	Y 20°		-21
	A 4000K	V 50°		-0Z
		R 14°+41° transversal		
	Q 14°+41° longitudinal			

CE IP40

Caratteristiche illuminotecniche / Lighting specifications

Watt	mA	LED Lumen	Product Lumen	Colour T (K)	CRI
10,4	350	1100	880	2700	90
		1100	880	3000	90
		1100	880	4000	90

Driver da ordinare separatamente / Driver to be ordered separately

- 81-04010** Output 350mA - max 1 apparecchio / max 1 fitting
Regolabile sul taglio di fase / Dimmable on the mains
- 81-04003** Output 350mA - max 3 apparecchi / max 3 fittings
Dimmerabile DALI, 1-10V, Push / DALI dimmable, 1-10V, Push
- 81-04090** Output 350mA
Wireless Bluetooth

Reference configurator

Il codice prodotto si compone mettendo in fila, da sinistra a destra, i dati contenuti nelle colonne a partire da "Codice base".

The product code is created by putting in sequence the data starting from "Base code", from left to right.

es: 278-019AQN-0Z



Codice base Base code	Lunghezza Length (mm)	Finitura Finish
--------------------------	--------------------------	--------------------

Binario 48V quadro a bassa tensione applicato ad incasso con aletta per chiusura a filo / 48V low voltage square track for recessed application with flap for flush closing

6700-	10 1000mm	-16
	15 1500mm	-21
		-0Z

48V_{dc}



Equipaggiabile con proiettori 48V_{dc}, vedi pag. 224
It can be equipped with 48V_{dc} track lights, see page 224

- 21 Bianco mat / Mat white
- 16 Nero / Black
- 0Z Nero primer / Black primer

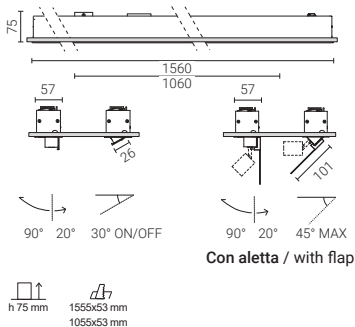

Accessori / Accessories

7606-06 (2000 mm)
Kit sospensione con cavo acciaio, piastrina 60 mm e bloccacavo automatico
Suspension kit with steel wire, 60 mm plate and automatic locking device

30 31 10

7626-00-00 (1000 mm)
Kit sospensione con tige e rosone traslucido / Suspension kit with pipe and translucent ceiling base

4 10

7607-00-00
Kit attacco soffitto
Ceiling kit

10 10

6461-00 (1000 mm)
Copertura binario
Track cover

30 31 10 10

6510-00 (1000 mm)
Aletta di copertura
Closing flap

21 16 0Z

6515-00 (1500 mm)
Aletta di copertura
Closing flap

21 16 0Z

MINIROOLER - IN

5 LUCI / 5 LIGHTS

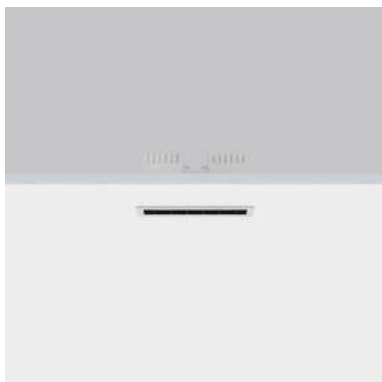

21 **Bianco mat**
Mat white

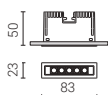

h 50 mm
19x79 mm
0,1 Kg



Reference configurator

Il codice prodotto si compone mettendo in fila, da sinistra a destra, i dati contenuti nelle colonne a partire da "Codice base".

The product code is created by putting in sequence the data starting from "Base code", from left to right.

es: **272-019BYN-21**

Codice base Base code	Colour T (K)	Fascio Beam	No driver	Finitura Finish
--------------------------	-----------------	----------------	-----------	--------------------

Con cornice e 5 microlenti in PMMA, per applicazione a incasso
With frame and 5 PMMA microlenses, for recessed application

272-019	C 2700K	Z 12°	N	-21
	B 3000K	Y 20°		
	A 4000K	V 50°		
	Q 14°+41° longitudinal			

CE 850° IP40

Caratteristiche illuminotecniche / Lighting specifications

Watt	mA	LED Lumen	Product Lumen	Colour T (K)	CRI
5,2	350	550	440	2700	90
		550	440	3000	90
		550	440	4000	90
7,5	500	750	600	2700	90
		750	600	3000	90
		750	600	4000	90

Driver da ordinare separatamente, per installazione attraverso il foro d'incasso
Driver should be ordered separately, for installation through the recessed hole

81-04076	Output 350mA*
81-04078	Output 500mA*
81-04081	Output 500mA Dimmerabile DALI / DALI dimmable
81-04084	Output 500mA Dimmerabile 1-10V / 1-10V dimmable

* Per una corretta installazione, considerare una profondità di incasso a soffitto di H180 mm x L120 mm
For a correct installation, please consider a ceiling recessed depth of H180 mm x L120 mm

Driver da ordinare separatamente, per installazione in posizione remota
Driver should be ordered separately, for remote installation

81-02506	Output 350mA max 2 apparecchi / max 2 fittings
81-04003	Output 350mA max 3 apparecchi / max 3 fittings Dimmerabile DALI, 1-10V, Push / DALI dimmable, 1-10V, Push
81-02472	Output 350mA Regolabile sul taglio di fase / Dimmable on the mains
81-02517	Output 500mA max 2 apparecchi / max 2 fittings
81-04002	Output 500mA max 2 apparecchi / max 2 fittings Dimmerabile DALI / DALI dimmable
81-04029	Output 500mA Regolabile sul taglio di fase / Dimmable on the mains
81-04087	Output 500mA Wireless Bluetooth

MINIROOLER - IN

15 LUCI / 15 LIGHTS

Incassi e semi-incassi

Downlights and semi-recessed lights

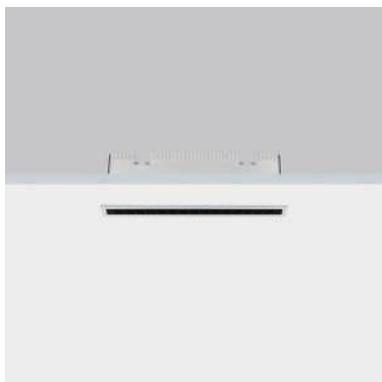

21 **Bianco mat**
Mat white

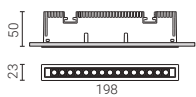

h 50 mm 19x194 mm 0,3 Kg



Longitudinale
Longitudinal

Reference configurator

Il codice prodotto si compone mettendo in fila, da sinistra a destra, i dati contenuti nelle colonne a partire da "Codice base".

The product code is created by putting in sequence the data starting from "Base code", from left to right.

es: **273-019CVN-21**

Codice base Base code	Colour T (K)	Fascio Beam	No driver	Finitura Finish
--------------------------	-----------------	----------------	-----------	--------------------

Con cornice e 15 microlenti in PMMA, per applicazione a incasso
With frame and 15 PMMA microlenses, for recessed application

273-019	C 2700K	Z 12°	N	-21
	B 3000K	Y 20°		
	A 4000K	V 50°		
	Q 14°+41° longitudinal			

CE IP40

Caratteristiche illuminotecniche / Lighting specifications

Watt	mA	LED Lumen	Product Lumen	Colour T (K)	CRI
15,5	350	1650	1320	2700	90
		1650	1320	3000	90
		1650	1320	4000	90
17,5	400	1800	1440	2700	90
		1800	1440	3000	90
		1800	1440	4000	90

Driver da ordinare separatamente, per installazione attraverso il foro d'incasso
Driver should be ordered separately, for installation through the recessed hole

81-04076	Output 350mA*
81-04079	Output 350mA Dimmerabile DALI / DALI dimmable
81-04082	Output 350mA Dimmerabile 1-10V / 1-10V dimmable
81-04077	Output 400mA*
81-04080	Output 400mA Dimmerabile DALI / DALI dimmable
81-04083	Output 400mA Dimmerabile 1-10V / 1-10V dimmable

* Per una corretta installazione, considerare una profondità di incasso a soffitto di H140 mm x L120 mm
For a correct installation, please consider a ceiling recessed depth of H140 mm x L120 mm

Driver da ordinare separatamente, per installazione in posizione remota
Driver should be ordered separately, for remote installation

81-02506	Output 350mA
81-04003	Output 350mA Dimmerabile DALI, 1-10V, Push / DALI dimmable, 1-10V, Push
81-02464	Output 350mA Regolabile sul taglio di fase / Dimmable on the mains
81-02571	Output 400mA
81-02565	Output 400mA Dimmerabile DALI / DALI dimmable
81-04057	Output 400mA Dimmerabile 1-10V / 1-10V dimmable

MINIROOLER - TL

5 LUCI / 5 LIGHTS

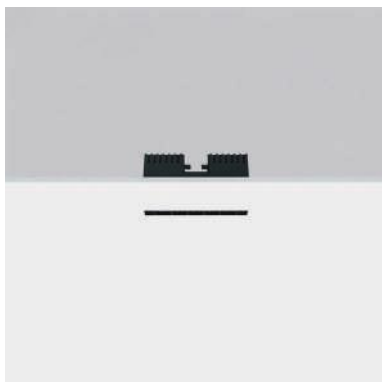

16 Nero
Black

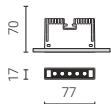

h 70 mm 24x82 mm 0,1 Kg



Longitudinale
Longitudinal

Reference configurator

Il codice prodotto si compone mettendo in fila, da sinistra a destra, i dati contenuti nelle colonne a partire da "Codice base".

The product code is created by putting in sequence the data starting from "Base code", from left to right.

es: 274-019AQN-16

Codice base Base code	Colour T (K)	Fascio Beam	No driver	Finitura Finish
--------------------------	-----------------	----------------	-----------	--------------------

Senza cornice e 5 microlenti in PMMA, per applicazione a incasso
Trimless and 5 PMMA microlenses, for recessed application

274-019	C 2700K	Z 12°	N	-16
	B 3000K	Y 20°		
	A 4000K	V 50°		
	Q 14°+41° longitudinal			

CE IP40

Caratteristiche illuminotecniche / Lighting specifications

Watt	mA	LED Lumen	Product Lumen	Colour T (K)	CRI
5,2	350	550	440	2700	90
		550	440	3000	90
		550	440	4000	90
7,5	500	750	600	2700	90
		750	600	3000	90
		750	600	4000	90

Driver da ordinare separatamente, per installazione attraverso il foro d'incasso
Driver should be ordered separately, for installation through the recessed hole

81-04076	Output 350mA*
81-04078	Output 500mA*
81-04081	Output 500mA Dimmerabile DALI / DALI dimmable
81-04084	Output 500mA Dimmerabile 1-10V / 1-10V dimmable

* Per una corretta installazione, considerare una profondità di incasso a soffitto di H180 mm x L120 mm
For a correct installation, please consider a ceiling recessed depth of H180 mm x L120 mm

Driver da ordinare separatamente, per installazione in posizione remota
Driver should be ordered separately, for remote installation

81-02506	Output 350mA max 2 apparecchi / max 2 fittings
81-04003	Output 350mA max 3 apparecchi / max 3 fittings Dimmerabile DALI, 1-10V, Push / DALI dimmable, 1-10V, Push
81-02472	Output 350mA Regolabile sul taglio di fase / Dimmable on the mains
81-02517	Output 500mA max 2 apparecchi / max 2 fittings
81-04002	Output 500mA max 2 apparecchi / max 2 fittings Dimmerabile DALI / DALI dimmable
81-04029	Output 500mA Regolabile sul taglio di fase / Dimmable on the mains
81-04087	Output 500mA Wireless Bluetooth

MINIROOLER - TL

15 LUCI / 15 LIGHTS

Incassi e semi-incassi

Downlights and semi-recessed lights



16 Nero
Black

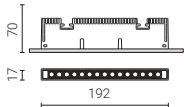

h 70 mm 24x197 mm 0,4 Kg



Longitudinale
Longitudinal

Reference configurator

Il codice prodotto si compone mettendo in fila, da sinistra a destra, i dati contenuti nelle colonne a partire da "Codice base".

The product code is created by putting in sequence the data starting from "Base code", from left to right.

es: 275-019BZN-16

Codice base Base code	Colour T (K)	Fascio Beam	No driver	Finitura Finish
--------------------------	-----------------	----------------	-----------	--------------------

Senza cornice e 15 microlenti in PMMA, per applicazione a incasso
Trimless and 15 PMMA microlenses, for recessed application

275-019	C 2700K	Z 12°	N	-16
	B 3000K	Y 20°		
	A 4000K	V 50°		
	Q 14°+41° longitudinal			

CE IP40

Caratteristiche illuminotecniche / Lighting specifications

Watt	mA	LED Lumen	Product Lumen	Colour T (K)	CRI
15,5	350	1650	1320	2700	90
		1650	1320	3000	90
		1650	1320	4000	90
17,5	400	1800	1440	2700	90
		1800	1440	3000	90
		1800	1440	4000	90

Driver da ordinare separatamente, per installazione attraverso il foro d'incasso
Driver should be ordered separately, for installation through the recessed hole

81-04076	Output 350mA*
81-04079	Output 350mA Dimmerabile DALI / DALI dimmable
81-04082	Output 350mA Dimmerabile 1-10V / 1-10V dimmable
81-04077	Output 400mA*
81-04080	Output 400mA Dimmerabile DALI / DALI dimmable
81-04083	Output 400mA Dimmerabile 1-10V / 1-10V dimmable

* Per una corretta installazione, considerare una profondità di incasso a soffitto di H140 mm x L120 mm
For a correct installation, please consider a ceiling recessed depth of H140 mm x L120 mm

Driver da ordinare separatamente, per installazione in posizione remota
Driver should be ordered separately, for remote installation

81-02506	Output 350mA
81-04003	Output 350mA Dimmerabile DALI, 1-10V, Push / DALI dimmable, 1-10V, Push
81-02464	Output 350mA Regolabile sul taglio di fase / Dimmable on the mains
81-02571	Output 400mA
81-02565	Output 400mA Dimmerabile DALI / DALI dimmable
81-04057	Output 400mA Dimmerabile 1-10V / 1-10V dimmable

PERFETTO - IN 40 CON LENTE / WITH LENS



21 Bianco mat
Mat white

16 Nero
Black

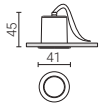

h 45 mm
Ø 36 mm
0,1 Kg

Codice base Base code	Colour T (K)	Fascio Beam	No driver	Finitura Finish
--------------------------	-----------------	----------------	-----------	--------------------

Fisso con lente non sostituibile e vetro zigrinato
Fixed with not replaceable lens and prismatic spread lens

254-219	C 2700K	Z 14°	N	-16
	B 3000K	X 30°		-21
	A 4000K			



Caratteristiche illuminotecniche / Lighting specifications

Watt	mA	LED Lumen	Product Lumen	Colour T (K)	CRI
2	500	130	110	2700	90
		150	127	3000	90
3	700	180	153	2700	90
		200	170	3000	90

Driver per installazione in posizione remota, da ordinare separatamente
Driver for remote installation, to be ordered separately

81-04019 Output 500mA (max 20W) - max 8 apparecchi / max 8 fittings
Corrente costante / Constant current

81-02531 Output 700mA (max 12W) - max 3 apparecchi / max 3 fittings
Corrente costante / Constant current

PERFETTO - IN 50 CON LENTE / WITH LENS



21 Bianco mat
Mat white

16 Nero
Black

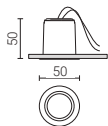

h 50 mm
Ø 43 mm
0,1 Kg

Codice base Base code	Colour T (K)	Fascio Beam	No driver	Finitura Finish
--------------------------	-----------------	----------------	-----------	--------------------

Fisso con lente in PMMA e schermo in termoplastico satinato
Fixed with PMMA lens and frosted thermoplastic screen

225-039	C 2700K	Y 21°	N	-16
	B 3000K	W 38°		-21
	A 4000K	R 15°+41°		



Caratteristiche illuminotecniche / Lighting specifications

Watt	mA	LED Lumen	Product Lumen	Colour T (K)	CRI
6	500	579	498	2700	90
		611	525	3000	90
		654	562	4000	90

Driver da ordinare separatamente / Driver should be ordered separately

81-04029 Output 500mA
Regolabile sul taglio di fase / Dimmable on the mains

81-04026 Output 500mA
Dimmerabile DALI / DALI dimmable

 **81-04087** Output 500mA
Wireless Bluetooth

Accessori ottici intercambiabili solo per Perfetto - IN 40 con lente
Replaceable optical accessories only for Perfetto - IN 40 with lens

Accessori ottici intercambiabili solo per Perfetto - IN 50 con lente
Replaceable optical accessories only for Perfetto - IN 50 with lens



28-4105-100
Cilindro oro satinato
Satined gold baffle



28-4499-30
Frangiluce alveolare
Honeycomb



21 Bianco mat Mat white 16 Nero Black

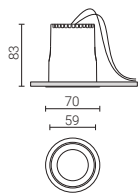

h 83 mm Ø 70 mm 0,3 Kg

Reference configurator

Il codice prodotto si compone mettendo in fila, da sinistra a destra, i dati contenuti nelle colonne a partire da "Codice base".

The product code is created by putting in sequence the data starting from "Base code", from left to right.

es: 262-039ANX-21

Codice base Base code	Colour T (K)	No driver	Fascio Beam	Finitura Finish
Fisso con schermo in termoplastico trasparente Fixed with clear thermoplastic screen				
262-039	C 2700K	N	Y 21°	-16
	B 3000K		X 38°	-21
	A 4000K		W 44°	

Codice base Base code	Colour T (K)	No driver	Fascio Beam	Finitura Finish
Sistema Dim to Warm / Dim to Warm system				
262-049	M 1800-2700K	N	Y 21°	-16
			X 38°	-21
			W 44°	

CE 850° IP43 IK08

Caratteristiche illuminotecniche / Lighting specifications

Watt	mA	LED Lumen	Product Lumen	Colour T (K)	CRI
6	180	770	440	2700	90
		800	464	3000	90
		907	526	4000	90
9	250	1050	609	2700	90
		1090	632	3000	90
		1291	749	4000	90
12	350	1430	830	2700	90
		1470	853	3000	90
		1702	987	4000	90
		1130*	656	1800-2700 Dim to Warm	90

*Valore riferito alla massima dimmerazione
Value referring to max dimming

Driver da ordinare separatamente / Driver should be ordered separately

- 81-04023** Output 180mA
Regolabile sul taglio di fase e 1-10V
Dimmable on the mains and 1-10V
- 81-04009** Output 250mA
- 81-04010** Output 350mA
Regolabile sul taglio di fase (anche per Dim to Warm)
Dimmable on the mains (also for Dim to Warm)
- 81-04003** Output 350mA
Dimmerabile DALI (anche per Dim to Warm)
DALI dimmable (also for Dim to Warm)
- 81-04090** Output 350mA
Wireless Bluetooth (anche per Dim to Warm / also for Dim to Warm)

Accessori ottici intercambiabili / Replaceable optical accessories

28-4039-100
Cilindro oro satinato
Satinated gold baffle

28-4039-31
Cilindro bianco
White baffle

28-4208-30
Frangiluce alveolare
Honeycomb

28-4065-47
Vetro zigrinato (utilizzare al posto dello schermo di chiusura in dotazione)
Prismatic spread lens (to be used only instead of included closing screen)

28-4065-61
Vetro sabbiato (utilizzare al posto dello schermo di chiusura in dotazione)
Frosted glass (to be used only instead of included closing screen)

28-4065-103
Vetro ellittico (utilizzare al posto dello schermo di chiusura in dotazione)
Elliptical spread lens (to be used only instead of included closing screen)

PERFETTO - IN 70 WALL WASHER



21 Bianco mat
Mat white

16 Nero
Black

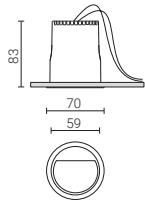

h 83 mm
Ø 70 mm
0,3 Kg

Reference configurator

Il codice prodotto si compone mettendo in fila, da sinistra a destra, i dati contenuti nelle colonne a partire da "Codice base".

The product code is created by putting in sequence the data starting from "Base code", from left to right.

es: 262-019CNWW-21

Codice base Base code	Colour T (K)	No driver	Fascio Beam	Finitura Finish
--------------------------	-----------------	-----------	----------------	--------------------

Fisso con lente effetto wall washer

Fixed with wall washer lens

262-019	C 2700K	N	WW	-16
	B 3000K			-21
	A 4000K			

CE 850° IP43

Caratteristiche illuminotecniche / Lighting specifications

Watt	mA	LED Lumen	Product Lumen	Colour T (K)	CRI
6	180	770	693	2700	90
		800	720	3000	90
		907	526	4000	90
9	250	1050	945	2700	90
		1090	981	3000	90
		1291	749	4000	90

Driver da ordinare separatamente / Driver should be ordered separately

81-04023 Output 180mA
Regolabile sul taglio di fase e 1-10V / Dimmable on the mains and 1-10V

81-04009 Output 250mA

81-04003-250 Output 250mA
Dimmerabile DALI / DALI dimmable

81-04091 Output 250mA
Wireless Bluetooth

PERFETTO - IN 60

CON LENTE / WITH LENS



21 **Bianco mat**
Mat white

16 **Nero**
Black

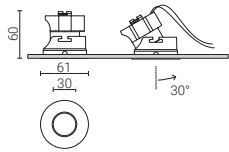

h 60 mm
Ø 57 mm
0.2 Kg

Reference configurator

Il codice prodotto si compone mettendo in fila, da sinistra a destra, i dati contenuti nelle colonne a partire da "Codice base".

The product code is created by putting in sequence the data starting from "Base code", from left to right.

es: 260-049MYN-16

Incassi e semi-incassi

Downlights and semi-recessed lights

Codice base Colour Fascio No driver Finitura
Base code T (K) Beam Finish

Oscillante con lente in PMMA / Tilttable with PMMA lens

260-069	C 2700K	Y 21°	N	-16
	B 3000K	W 38°		-21
	A 4000K	R 15°+41°		

Codice base Colour Fascio No driver Finitura
Base code T (K) Beam Finish

Sistema Dim to Warm / Dim to Warm system

🔌 260-049	M 1800-2700K	Y 21°	N	-16
		W 38°		-21
		R 15°+41°		

CE IP43

Caratteristiche illuminotecniche / Lighting specifications

Watt	mA	LED Lumen	Product Lumen	Colour T (K)	CRI
6	500	579	492	2700	90
		611	519	3000	90
		654	562	4000	90
5	300	494*	420	1800-2700 Dim to Warm	90

*Valore riferito alla massima dimmerazione
Value referring to max dimming

Driver da ordinare separatamente / Driver should be ordered separately

- 81-04029** Output 500mA
Regolabile sul taglio di fase / Dimmable on the mains
- 81-04026** Output 500mA
Dimmerabile DALI / DALI dimmable
- 📶 **81-04087** Output 500mA
Wireless Bluetooth
- 🔌 **81-04075** Output 300mA
Regolabile sul taglio di fase / Dimmable on the mains
- 🔌 **81-04074** Output 300mA
Dimmerabile DALI / DALI dimmable
- 🔌 **81-04072** Output 300mA
Dimmerabile 1-10V / 1-10V dimmable
- 📶 **81-04089** Output 300mA
Wireless Bluetooth

Accessori ottici intercambiabili / Replaceable optical accessories



28-4499-30
Frangiluce alveolare
Honeycomb



28-4449-47
Vetro zigrinato
Prismatic spread lens

PERFETTO - IN 80

CON LENTE / WITH LENS



21 Bianco mat
Mat white

16 Nero
Black

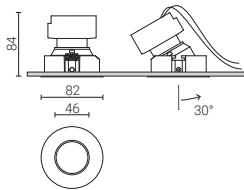

h 85 mm
Ø 75 mm
0,4 Kg

Reference configurator

Il codice prodotto si compone mettendo in fila, da sinistra a destra, i dati contenuti nelle colonne a partire da "Codice base".

The product code is created by putting in sequence the data starting from "Base code", from left to right.

es: 268-069BWN-16

Codice base Base code	Colour T (K)	Fascio Beam	No driver	Finitura Finish
--------------------------	-----------------	----------------	-----------	--------------------

Oscillante con lente in PMMA e schermo in termoplastico satinato
Tilttable with PMMA lens and frosted thermoplastic screen

268-069	C 2700K	Y 21°	N	-16
	B 3000K	W 38°		
	A 4000K			

CE IP43 IK08

Caratteristiche illuminotecniche / Lighting specifications

Watt	mA	LED Lumen	Product Lumen	Colour T (K)	CRI
6	500	579	498	2700	90
		611	525	3000	90
		654	562	4000	90
8,7	700	766	659	2700	90
		809	696	3000	90
		866	745	4000	90

Driver da ordinare separatamente / Driver should be ordered separately

81-04029 Output 500mA
Regolabile sul taglio di fase / Dimmable on the mains

81-04002 Output 500mA
Dimmerabile DALI / DALI dimmable

81-04027 Output 700mA
Regolabile sul taglio di fase / Dimmable on the mains

81-04028 Output 700mA*
Dimmerabile DALI / DALI dimmable

*Per una corretta installazione, considerare una profondità di incasso a soffitto di 200mm.
For a correct installation, please consider a ceiling recessed depth of 200 mm.

81-04088
Output 700mA
Wireless Bluetooth

Accessori ottici intercambiabili / Replaceable optical accessories



28-4163-30
Frangiluce alveolare
Honeycomb



21 Bianco mat
Mat white

16 Nero
Black

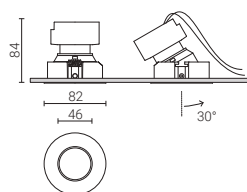

h 85 mm
Ø 75 mm
0,4 Kg

Reference configurator

Il codice prodotto si compone mettendo in fila, da sinistra a destra, i dati contenuti nelle colonne a partire da "Codice base".

The product code is created by putting in sequence the data starting from "Base code", from left to right.

es: 268-039CYN-21

Codice base Base code	Colour T (K)	Fascio Beam	No driver	Finitura Finish
--------------------------	-----------------	----------------	-----------	--------------------

Oscillante / Tilttable

268-039	C 2700K	Y 21°	N	-16
	B 3000K	X 38°		-21
	A 4000K			

CE IP20 IK08

Caratteristiche illuminotecniche / Lighting specifications

Watt	mA	LED Lumen	Product Lumen	Colour T (K)	CRI
6	180	770	432	2700	90
		800	448	3000	90
		907	508	4000	90
9	250	1050	588	2700	90
		1090	611	3000	90
		1291	723	4000	90
12	350	1430	801	2700	90
		1470	824	3000	90
		1702	953	4000	90
18	500	1850	1036	2700	90
		1917	1074	3000	90
		2360	1322	4000	90

Driver da ordinare separatamente / Driver should be ordered separately

81-04023	Output 180mA Regolabile sul taglio di fase e 1-10V / Dimmable on the mains and 1-10V
81-04009	Output 250mA
81-04010	Output 350mA Regolabile sul taglio di fase / Dimmable on the mains
81-04003	Output 350mA Dimmerabile DALI / DALI dimmable
81-04011	Output 500mA
81-04002	Output 500mA Dimmerabile DALI / DALI dimmable
81-04092	Output 500mA Wireless Bluetooth

Accessori ottici intercambiabili / Replaceable optical accessories



28-4163-30
Frangiluce alveolare
Honeycomb



28-3905-47
Schermo di chiusura in
termoplastico trasparente
Closing screen in clear
thermoplastic material



28-4074-47
Vetro zigrinato
Prismatic spread lens



28-4073-61
Vetro sabbaiato
Frosted glass



28-4073-103
Vetro ellittico
Elliptical spread lens

PERFETTO - IN 90



21 Bianco mat
Mat white

16 Nero
Black

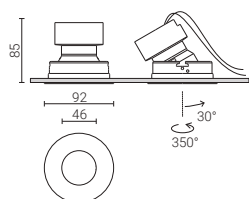

h 85 mm
Ø 84 mm
0,4 Kg



Codice base Base code	Colour T (K)	Fascio Beam	No driver	Finitura Finish	Codice base Base code	Colour T (K)	Fascio Beam	No driver	Finitura Finish
Oscillante e rotante / Rotatable and tiltable					☺ Dim to Warm - oscillante e rotante / rotatable and tiltable				
263-039	C 2700K	Y 21°	N	-16	263-049	M 1800-2700K	Y 21°	N	-16
	B 3000K	X 38°		-21			X 38°	-21	
	A 4000K								

CE IP20 IK08

Caratteristiche illuminotecniche / Lighting specifications

Watt	mA	LED Lumen	Product Lumen	Colour T (K)	CRI
6	180	770	432	2700	90
		800	448	3000	90
		907	508	4000	90
9	250	1050	588	2700	90
		1090	611	3000	90
		1291	723	4000	90
12	350	1430	801	2700	90
		1470	824	3000	90
		1702	953	4000	90
		☺ 1130*	633	1800-2700 Dim to Warm	90
18	500	1850	1036	2700	90
		1917	1074	3000	90
		2360	1322	4000	90

*Valore riferito alla massima dimmerazione
Value referring to max dimming

Reference configurator

Il codice prodotto si compone mettendo in fila, da sinistra a destra, i dati contenuti nelle colonne a partire da "Codice base".

The product code is created by putting in sequence the data starting from "Base code", from left to right.

es: 263-039AYN-21

Driver da ordinare separatamente / Driver should be ordered separately

81-04023	Output 180mA Regolabile sul taglio di fase e 1-10V / Dimmable on the mains and 1-10V
81-04009	Output 250mA
☺ 81-04010	Output 350mA Regolabile sul taglio di fase (anche per Dim to Warm) / Dimmable on the mains (also for Dim to Warm)
☺ 81-04003	Output 350mA Dimmerabile DALI (anche per Dim to Warm) / DALI dimmable (also for Dim to Warm)
☺ 81-04090	Output 350mA Wireless Bluetooth (anche per Dim to Warm / also for Dim to Warm)
81-04011	Output 500mA
81-04002	Output 500mA Dimmerabile DALI / DALI dimmable
☺ 81-04092	Output 500mA Wireless Bluetooth

Accessori ottici intercambiabili / Replaceable optical accessories



28-4163-30
Frangiluce alveolare
Honeycomb



28-3905-47
Schermo di chiusura in
termoplastico trasparente
Closing screen in clear
thermoplastic material



28-4074-47
Vetro zigrinato
Prismatic spread lens



28-4073-61
Vetro sabbato
Frosted glass



28-4073-103
Vetro ellittico
Elliptical spread lens

Accessori su richiesta / Accessories on demand



28-4318-21
Cornice quadra bianco mat
Mat white square frame

Ø 100 mm

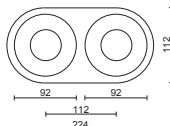

28-4181-21
Cornice tonda doppia bianco mat
Mat white twin round frame

2 x Ø 100 mm



RA 7



21 **Bianco mat**
Mat white

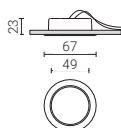

h 23 mm Ø 60 mm 0.2 Kg

Codice base Base code	Colour T (K)	Fascio Beam	No driver	Finitura Finish
--------------------------	-----------------	----------------	-----------	--------------------

Con lente in PMMA / With PMMA lens

251-259	C 2700K	Z 14°	N	-21
	B 3000K	W 36°		
	A 4000K			

CE IP43 IK07

Caratteristiche illuminotecniche / Lighting specifications

Watt	mA	LED Lumen	Product Lumen	Colour T (K)	CRI
4,1	350	429	356	2700	90
		453	376	3000	90
		491	408	4000	90
6	500	579	481	2700	90
		619	514	3000	90
		654	543	4000	90

Driver da ordinare separatamente / Driver should be ordered separately

81-02408	Output 350mA
81-04003	Output 350mA Dimmerabile DALI / DALI dimmable
81-04008	Output 500mA Regolabile sul taglio di fase e 1-10V Dimmable on the mains and 1-10V
81-04002	Output 500mA Dimmerabile DALI / DALI dimmable
81-04087	Output 500mA Wireless Bluetooth

RA 8 SOFT DIXIT LED



21 **Bianco mat** 16 **Nero**
Mat white Black

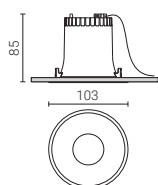

h 85 mm Ø 96 mm 0.3 Kg

Codice base Base code	Colour T (K)	No driver	Fascio Beam	Finitura Finish
--------------------------	-----------------	-----------	----------------	--------------------

238-039	C 2700K	N	Y 26°	-16
	B 3000K		V 45°	
	A 4000K		T 65°	

CE IP43 IK08

Caratteristiche illuminotecniche / Lighting specifications

Watt	mA	LED Lumen	Product Lumen	Colour T (K)	CRI
9	250	1078	787	2700	90
		1148	838	3000	90
		1241	906	4000	90
12	350	1478	1079	2700	90
		1574	1149	3000	90
		1700	1241	4000	90

Driver da ordinare separatamente / Driver should be ordered separately

81-04009	Output 250mA
81-04042	Output 250mA Dimmerabile DALI / DALI dimmable
81-04010	Output 350mA Regolabile sul taglio di fase / Dimmable on the mains
81-04003	Output 350mA Dimmerabile DALI / DALI dimmable
81-04090	Output 350mA Wireless Bluetooth



21 **Bianco mat** / Mat white
 16 **Nero** / Black

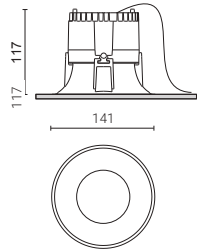

h 117 mm Ø 134 mm 0,7 Kg

Reference configurator

Il codice prodotto si compone mettendo in fila, da sinistra a destra, i dati contenuti nelle colonne a partire da "Codice base".

The product code is created by putting in sequence the data starting from "Base code", from left to right.

es: 258-200ANV-16

Codice base Base code	Colour T (K)	No driver	Fascio Beam	Finitura Finish
258-200	C 2700K	N	Y 18°	-16
	B 3000K		X 30°	-21
	A 4000K		V 55°	
			T 70°	

CE IP43 IK09

Caratteristiche illuminotecniche / Lighting specifications

Watt	mA	LED Lumen	Product Lumen	Colour T (K)	CRI
12	350	1726	1536	2700	85
		1821	1621	3000	85
		1843	1640	4000	85
18	500	2392	2129	2700	85
		2524	2246	3000	85
		2555	2274	4000	85
26	700	3223	2868	2700	85
		3400	3026	3000	85
		3442	3063	4000	85

Driver da ordinare separatamente / Driver should be ordered separately

- 81-04010** Output 350mA
Regolabile sul taglio di fase / Dimmable on the mains
- 81-04003** Output 350mA
Dimmerabile DALI / DALI dimmable
- 81-04011** Output 500mA
- 81-04002** Output 500mA
Dimmerabile DALI / DALI dimmable
- 81-04092** Output 500mA
Wireless Bluetooth
- 81-04012** Output 700mA
- 81-04044** Output 700mA
Regolabile sul taglio di fase / Dimmable on the mains
- 81-02413** Output 700mA
Dimmerabile DALI / DALI dimmable
- 81-04066** Output 700mA
Regolabile 1-10V / Push / Dimmable 1-10V / Push

Accessori ottici intercambiabili / Replaceable optical accessories



28-4019-30
Frangiluce alveolare
Honeycomb

PAFO

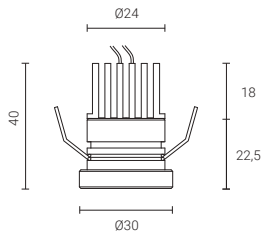

h 40 mm
 Ø 25 mm
 0,02 Kg

Codice base Base code	Ottica Optic	Fissaggio Fixing	Colour T (K)
--------------------------	-----------------	---------------------	-----------------

Variante da comporre a seconda delle proprie necessità
 Variant to compose according to your needs.

PF30 -	Z 2700K
	C 3000K
	N 4000K

350 mA

CE IP40

Caratteristiche illuminotecniche / Lighting specifications

Watt	mA	LED Lumen	Product Lumen	Colour T (K)	CRI
1	350	152	76	2700	83
		163	81,5	3000	83
		165	82,5	4000	83

Driver da ordinare separatamente / Drivers to be ordered separately

AL00048 Output 350mA
 On/Off
 Massimo numero farette 7 / Maximum number of spotlights 7

Controller da ordinare separatamente / Controller to be ordered separately

AL00078 Output 350mA
 DALI
 Minimo numero farette 2 / Minimum number of spotlights 2
 Massimo numero farette 12 / Maximum number of spotlights 12

Reference configurator

Il codice prodotto si compone mettendo in fila, da sinistra a destra, i dati contenuti nelle colonne a partire da "Codice base".

The product code is created by putting in sequence the data starting from "Base code", from left to right.

es: PF30-Z



ISIDE



01 **Bianco mat** Mat white
02 **Nero** Black

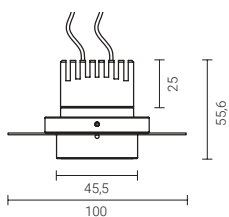

h 55,6 mm
Ø59 mm
0,12 Kg

Codice base Base code	Ottica Optic	Fissaggio Fixing	Colour T (K)	Finitura Finish
--------------------------	-----------------	---------------------	-----------------	--------------------

Variante da comporre a seconda delle proprie necessità
Variant to compose according to your needs.

IS -	1 15°		Z 2700K	01
	2 25°		C 3000K	02
	4 42°		N 4000K	

350 mA



Caratteristiche illuminotecniche / Lighting specifications

Watt	mA	LED Lumen	Product Lumen	Colour T (K)	CRI
3	350	484	435	2700	93
		526	473	3000	93
		608	574	4000	93

Driver da ordinare separatamente / Drivers to be ordered separately

AL00078 Output 350mA
On/Off - DALI
Massimo numero faretti 3/ Maximum number of spotlights 3

Reference configurator

Il codice prodotto si compone mettendo in fila, da sinistra a destra, i dati contenuti nelle colonne a partire da "Codice base".

The product code is created by putting in sequence the data starting from "Base code", from left to right.

es: IS-2N01

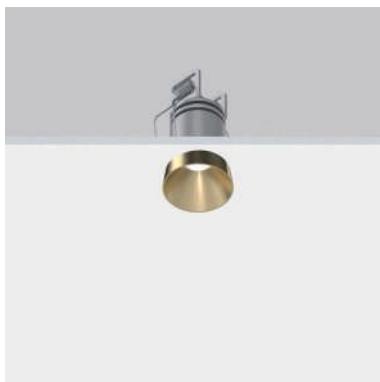

01 Bianco White 02 Nero Black 07 Oro Gold

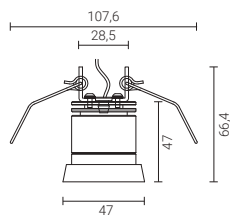

h 66 mm Ø 38,5 mm 0,10 Kg

Codice base Base code	Ottica Optic	Fissaggio Fixing	Colour T (K)	Finitura Finish
--------------------------	-----------------	---------------------	-----------------	--------------------

Variante da comporre a seconda delle proprie necessità
Variant to compose according to your needs.

CH47 -	1 13°		Z 2700K	01
	3 30°		C 3000K	02
	5 50°		N 4000K	07

500 mA



Caratteristiche illuminotecniche / Lighting specifications

Watt	mA	LED Lumen	Product Lumen	Colour T (K)	CRI
6	500	584	525	2700	93
		624	561	3000	93
		672	604	4000	93

Controller da ordinare separatamente / Controller to be ordered separately

AL00078 Output 500mA
On/Off - DALI
Massimo numero faretti 3/ Maximum number of spotlights 3

Reference configurator

Il codice prodotto si compone mettendo in fila, da sinistra a destra, i dati contenuti nelle colonne a partire da "Codice base".

The product code is created by putting in sequence the data starting from "Base code", from left to right.

es: CH47-1Z07

KARDAN - IN

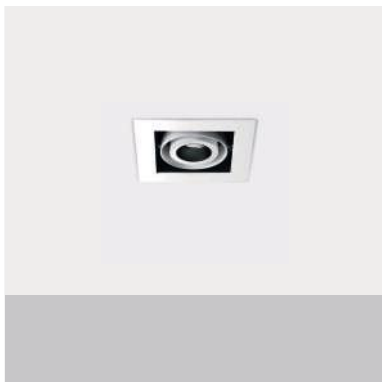

21 Bianco mat / Mat white 16 Nero / Black

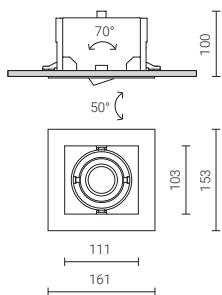

h 105 mm 135x130 mm 1,0 Kg

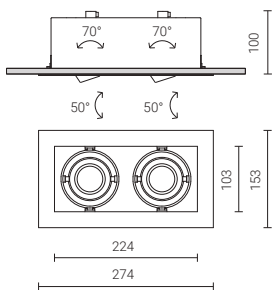

h 105 mm 135x245 mm 2,0 Kg

Codice base Base code	Colour T (K)	No driver	Fascio Beam	Finitura Finish
Con cornice, per applicazione a incasso - 1 luce With frame, for recessed application - 1 light				
508-211	C 2700K	N	Y 24°	-16
	B 3000K		X 30°	-21
	A 4000K		W 45°	
			V 55°	

Codice base Base code	Colour T (K)	No driver	Fascio Beam	Finitura Finish
Con cornice, per applicazione a incasso - 2 luci With frame, for recessed application - 2 lights				
508-221	C 2700K	N	Y 24°	-16
	B 3000K		X 30°	-21
	A 4000K		W 45°	
			V 55°	

CE IP20

Caratteristiche illuminotecniche / Lighting specifications

Watt	mA	LED Lumen	Product Lumen	Colour T (K)	CRI
12	350	1430	1044	2700	85
		1700	1241	3000	85
		1800	1314	4000	85
18	500	1850	1351	2700	85
		2400	1752	3000	85
		2500	1825	4000	85

Driver da ordinare separatamente / Driver should be ordered separately

- 81-04010** Output 350mA
Regolabile sul taglio di fase / Dimmable on the mains
- 81-04003** Output 350mA
Dimmerabile DALI / DALI dimmable
- 81-04011** Output 500mA
- 81-04002** Output 500mA
Dimmerabile DALI / DALI dimmable
- 81-04092** Output 500mA
Wireless Bluetooth
- 81-04012** Output 700mA (2x350mA)
- 81-04066** Output 700mA (2x350mA)
Regolabile 1-10V / Push
Dimmable 1-10V / Push
- 81-04021** Output 1000mA (2x500mA)

Accessori ottici intercambiabili / Replaceable optical accessories



28-4536-30
Frangiluce alveolare
Honeycomb



28-3905-47
Schermo di chiusura in
termoplastico trasparente
Closing screen in clear
thermoplastic material



16 Nero
Black

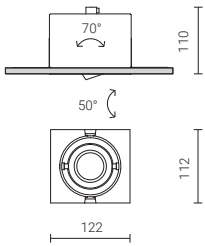

h 170 mm 115x124 mm 1,0 Kg

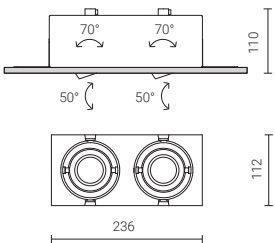

h 170 mm 115x238 mm 2,0 Kg

Codice base Base code	Colour T (K)	No driver	Fascio Beam	Finitura Finish
Senza cornice, per applicazione a incasso - 1 luce Trimless, for recessed application - 1 light				
509-211	C 2700K	N	Y 24°	-16
	B 3000K		X 30°	
	A 4000K		W 45°	
			V 55°	

Codice base Base code	Colour T (K)	No driver	Fascio Beam	Finitura Finish
Senza cornice, per applicazione a incasso - 2 luci Trimless, for recessed application - 2 lights				
509-221	C 2700K	N	Y 24°	-16
	B 3000K		X 30°	
	A 4000K		W 45°	
			V 55°	



Caratteristiche illuminotecniche / Lighting specifications

Watt	mA	LED Lumen	Product Lumen	Colour T (K)	CRI
12	350	1430	1044	2700	85
		1700	1241	3000	85
		1800	1314	4000	85
18	500	1850	1351	2700	85
		2400	1752	3000	85
		2500	1825	4000	85

Driver da ordinare separatamente / Driver should be ordered separately

- 81-04010** Output 350mA
Regolabile sul taglio di fase / Dimmable on the mains
- 81-04003** Output 350mA
Dimmerabile DALI / DALI dimmable
- 81-04011** Output 500mA
- 81-04002** Output 500mA
Dimmerabile DALI / DALI dimmable
- 81-04092** Output 500mA
Wireless Bluetooth
- 81-04012** Output 700mA (2x350mA)
- 81-04066** Output 700mA (2x350mA)
Regolabile 1-10V / Push
Dimmable 1-10V / Push
- 81-04021** Output 1000mA (2x500mA)

Accessori ottici intercambiabili / Replaceable optical accessories



28-4536-30
Frangiluce alveolare
Honeycomb



28-3905-47
Schermo di chiusura in
termoplastico trasparente
Closing screen in clear
thermoplastic material

NANOPERFETTO UP



21 **Bianco mat** Mat white
 16 **Nero** Black
 124 **Oro satinato** Satin gold

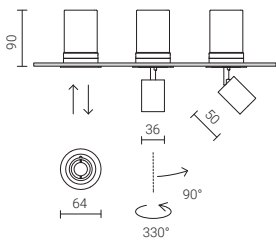

h 90 mm
 Ø 58 mm
 0,3 Kg

Codice base Base code	Colour T (K)	Fascio Beam	No driver	Finitura Finish
--------------------------	-----------------	----------------	-----------	--------------------

Proiettore estraibile per applicazione a incasso, con lente PMMA
 Pull-down spotlight for recessed application, with PMMA lens

269-039	C 2700K	Y 21°	N	-16
	B 3000K	W 38°		-21
		V 52°		-124

CE 850° IP20

Caratteristiche illuminotecniche / Lighting specifications

Watt	mA	LED Lumen	Product Lumen	Colour T (K)	CRI
4	350	417	359	2700	90
		441	379	3000	90

Driver da ordinare separatamente / Driver should be ordered separately

81-02408 Output 350mA

81-02090 Output 350mA
 Wireless Bluetooth

Reference configurator

Il codice prodotto si compone mettendo in fila, da sinistra a destra, i dati contenuti nelle colonne a partire da "Codice base".

The product code is created by putting in sequence the data starting from "Base code", from left to right.

es: 269-039BYN-124

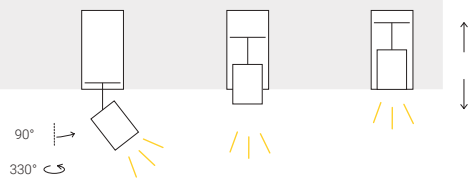

Accessori ottici intercambiabili / Replaceable optical accessories



28-4499-30
 Frangiluce alveolare
 Honeycomb

NANOPERFETTO - R

CON LENTE / WITH LENS



21 Bianco mat / Mat white
 16 Nero / Black
 124 Oro satinato / Satin gold

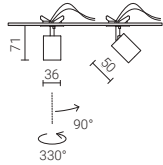

h 50 mm
 Ø 42 mm
 0,1 Kg

Reference configurator

Il codice prodotto si compone mettendo in fila, da sinistra a destra, i dati contenuti nelle colonne a partire da "Codice base".

The product code is created by putting in sequence the data starting from "Base code", from left to right.

es: 755-779CVN-16

Incassi e semi-incassi

Downlights and semi-recessed lights

Codice base / Base code Colour T (K) Fascio Beam No driver Finitura Finish

Con lente in PMMA e rosone per applicazione a incasso
 With PMMA lens and canopy for recessed application

755-779	C 2700K	Y 21°	N	-16
	B 3000K	W 38°		-21
		V 52°		-124
		R 15°+41°		

Codice base / Base code Colour T (K) Fascio Beam No driver Finitura Finish

Sistema Dim to Warm / Dim to Warm system

755-679	M 1800-2700K	Y 21°	N	-16
		W 38°		-21
		V 52°		-124
		R 15°+41°		

CE IP20

Caratteristiche illuminotecniche / Lighting specifications

Watt	mA	LED Lumen	Product Lumen	Colour T (K)	CRI	
5	300	494*	420	1800-2700 Dim to Warm	90	*Valore riferito alla massima dimmerazione Value referring to max dimming
6	500	579	498	2700	90	
		611	525	3000	90	
7,3	600	675	581	2700	90	
		713	613	3000	90	

Driver da ordinare separatamente, per installazione attraverso il foro d'incasso
 Driver should be ordered separately, for installation through the recessed hole

81-04029 Output 500mA
 Regolabile sul taglio di fase / Dimmable on the mains

81-04026 Output 500mA*
 Dimmerabile DALI / DALI dimmable

* Per una corretta installazione, considerare una profondità di incasso a soffitto di 200 mm
 For a correct installation, please consider a ceiling recessed depth of 200 mm

Driver da ordinare separatamente, per installazione in posizione remota
 Driver should be ordered separately, for remote installation

81-04075 Output 300mA
 Regolabile sul taglio di fase / Dimmable on the mains

81-04072 Output 300mA
 Dimmerabile 1-10V / 1-10V dimmable

81-04074 Output 300mA
 Dimmerabile DALI / DALI dimmable

81-04089 Output 300mA
 Wireless Bluetooth

81-04063 Output 600mA

81-04062 Output 600mA
 Dimmerabile DALI / DALI dimmable

81-04093 Output 600mA
 Wireless Bluetooth

Accessori ottici intercambiabili / Replaceable optical accessories



28-4499-30
 Frangiluce alveolare (solo per 5W e 6W)
 Honeycomb (only for 5W and 6W)

MICROPERFETTO LARGE - R

CON LENTE / WITH LENS



21 Bianco mat
Mat white

16 Nero
Black

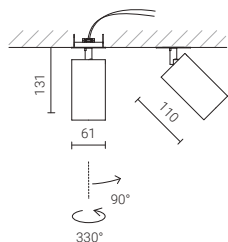

h 50 mm
Ø 55 mm
0,1 Kg

Reference configurator

Il codice prodotto si compone mettendo in fila, da sinistra a destra, i dati contenuti nelle colonne a partire da "Codice base".

The product code is created by putting in sequence the data starting from "Base code", from left to right.

es: 785-279AZN-21

Codice base	Colour	Fascio	No driver	Finitura
Base code	T (K)	Beam		Finish

Con lente in silicone e rosone per applicazione a incasso
With silicone lens and canopy for recessed application

785-279 17W / 25W / 29W	C 2700K	Z 21°	N	-16
	B 3000K	X 30°		-21
	A 4000K			

Codice base	Colour	No driver	Finitura
Base code	T (K)		Finish

Lente zoom regolabile in 7 posizioni e rosone per applicazione a incasso
Zoom lens adjustable in 7 positions and canopy for recessed application

784-179 18,5W	C 2700K	N	-16
	B 3000K		-21
	A 4000K		

Zoom technology

La rotazione del cilindro interno permette di modificare l'angolo del fascio da 13° a 47°.

The rotation of the internal snoot modifies the beam angle from 13° to 47°.

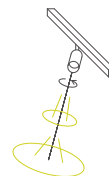

CE IP20

Caratteristiche illuminotecniche / Lighting specifications

Watt	mA	LED Lumen	Product Lumen	Colour T (K)	CRI	Fascio Beam
17	500	2049	1742	2700	90	
		2183	1855	3000	90	
		2360	2006	4000	90	
18,5	500	1216	1034	2700	90	13° to 47°
		1310	1114	3000	90	13° to 47°
		1815	1216	4000	90	13° to 47°
25	700	2650	2253	2700	90	
		2760	2346	3000	90	
		3179	2702	4000	90	
29	800	2980	2533	2700	90	
		3100	2635	3000	90	
		3566	3031	4000	90	

Driver da ordinare separatamente / Driver should be ordered separately

81-04011	Output 500mA
81-04002	Output 500mA Dimmerabile DALI / DALI dimmable
81-04092	Output 500mA Wireless Bluetooth
81-04067	Output 700mA Dimmerabile DALI / DALI dimmable
81-04068	Output 700mA Dimmerabile 1-10V / 1-10V dimmable
81-04069	Output 800mA
81-04070	Output 800mA Dimmerabile DALI / DALI dimmable
81-04071	Output 800mA Dimmerabile 1-10V / 1-10V dimmable



02

Punti

luci a binario 48V

48V track lights

Una luce morbida in forma flessibile

A soft light, in a flexible form

^{ITA} Caratterizzati da forme miniaturizzate, cilindriche e geometriche, sono progettati per soddisfare innumerevoli esigenze progettuali. Il design e le finiture strizzano l'occhio a contesti nei quali è richiesto non solo un apporto illuminotecnico performante, ma anche un'eleganza e stile, elementi che, di certo, non mancano ai prodotti di questa gamma.

^{EN} They can solve countless design needs, thanks to their miniaturized, cylindrical, and geometric shapes. The design and finishes wink at contexts in which not only a high-performance lighting contribution is needed but also elegance and style. Elements that, of course, are not lacking in the products in this range.

Linea 48 in finitura nera in combinazione con la luce d'accento dei proiettori Microperferetto 48Vdc.

Linea 48 black finish combined with the accent light of Microperferetto 48Vdc spotlights.





Villa Mirella – Ruta di Camogli (Interior & Lighting Design: SLAM Architects)



48V_{DC}

^{ITA} Binari elettrificati a bassa tensione 48V per applicazioni a soffitto, a parete, a sospensione e per installazioni a incasso trimless in controsoffitti. Predisposti per alloggiare i proiettori e sospensioni provvisti di adattatore 48V, sono realizzati in lega di alluminio estruso, verniciato poliester. I due conduttori per 48V portano anche il segnale DALI, consentendo la regolazione dinamica della luce.

Caratteristiche Tecniche

I binari elettrificati sono costruiti in lega di alluminio estruso. I cavi conduttori in rame sono alloggiati all'interno di profilati estrusi in PVC ad alta resistenza di isolamento. Certificati dall'Istituto Italiano Marchio di Qualità (IMQ), sono conformi alle norme vigenti (EN 60570).

I sistemi comprendono un'ampia varietà di accessori e di giunti di collegamento.

^{EN} 48V low voltage electrified tracks for ceiling, wall, suspension applications and for trimless recessed installations in false ceilings. They are compatible with spotlights and pendants equipped with 48V adapter. They are made of extruded aluminium alloy, polyester painted. The two 48V conductors can transmit also the DALI signal, allowing for the dynamic control of light.

Technical Specifications

Electrified tracks are made of extruded aluminium alloy. The copper wires are located inside extruded PVC profiles with high insulating properties. They are certified by the Italian Quality Marking Institution (IMQ) and they comply with current standards (EN 60570).

Every system includes a wide range of joints and accessories.

Continuità del polo positivo (vista in planimetria dall'alto)
 Continuity of the positive pole (top plan view)

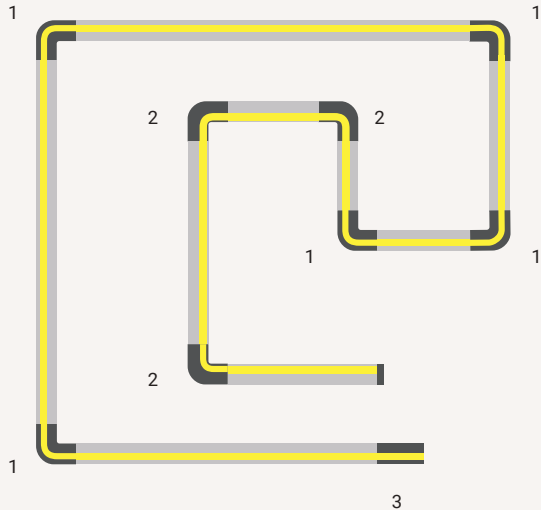

-  **1** Giunto L esterno
Outside L joint

-  **2** Giunto L interno
Inside L joint

-  **3** Alimentazione sinistra
Left live-end

ITA Capacità di Carico

Il binario può sopportare un carico di 4 Kg ogni 1000 mm. Nel caso di carico di 4 Kg, ogni 200 mm, la distanza di fissaggio deve essere di 500 mm. Il carico massimo è di 720 W (48V_{DC} - 15 A).

EN Load Capacity

The track has a load capacity of 4 Kg every 1000 mm. For a 4 Kg load every 200 mm a maximum fixing distance of 500 mm is recommended. Maximum load is 720 W (48VDC - 15 A)

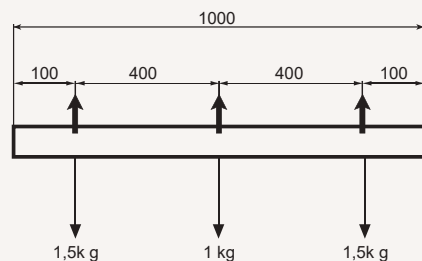
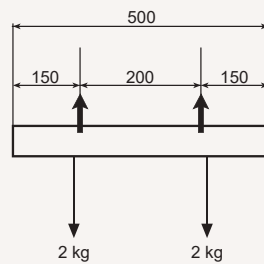

ITA Binario 48V Polarizzato

Per una corretta installazione di tutti gli accessori che concorrono alla formazione di un impianto di binari 48V, è importante seguire la continuità della linea di positivo tra ogni elemento.

EN Polarized 48V Track

The continuity of the positive line between each element is important for a correct installation of all the accessories in a 48V track composition.

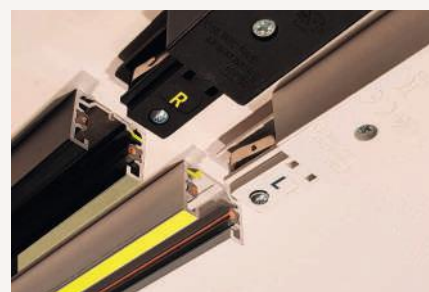

Alimentazione destra R
Right live-end R

Alimentazione sinistra L
Left live-end L



Schemi di dimmerazione
scaricabili dal sito

Dimming schemes can be
downloaded from the web site



^{ITA} La gamma di binari ARIA comprende binari dimmerabili, trifase, monofase e a bassa tensione, in grado di adattarsi in modo flessibile alle più svariate esigenze di illuminazione.

^{EN} The Ivela track range includes dimmable, three-phase, single-phase and low voltage tracks, able to fit with different lighting demands in a flexible way.

Caratteristiche Tecniche

I binari elettrificati sono costruiti in lega di alluminio estruso. I cavi conduttori in rame sono alloggiati all'interno di profilati estrusi in PVC ad alta resistenza di isolamento. Certificati dall'Istituto Italiano Marchio di Qualità (IMQ), sono conformi alle norme vigenti (EN 60570). I sistemi comprendono un'ampia varietà di accessori e di giunti di collegamento.

Technical Specifications

Electrified tracks are made of extruded aluminium alloy. The copper wires are located inside extruded PVC profiles with high insulating properties. They are certified by the Italian Quality Marking Institution (IMQ) and comply with current standards (EN 60570). A wide range of joints and accessories is available.



48V_{dc} / 48V_{dc}

ITA I binari elettrificati a bassa tensione 48VDC sono disponibili in tre differenti lunghezze e con diverse finiture di colore. I prodotti sono certificati dall'Istituto Italiano Marchio di Qualità (IMQ) e conformi alle normative vigenti (EN60570). La gamma di binari 48VDC sono predisposti per montare i proiettori provvisti dello specifico adattatore.

EN 48V_{dc} low voltage electrified are available in three different lengths and in different colours. They are certified by the Italian Quality Mark Institution (IMQ) and they comply with current Standards (EN 60570). The 48V_{dc} tracks range are compatible with spotlights equipped with the specific adapter.

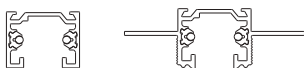

Quadro / Square Incasso TL / TL recessed



Linee di luce diffusa per l'architettura

Lines of diffused light for architecture

^{ITA} Linea 48 è una linea di luce da installare nei binari elettrificati 48VDC a bassa tensione. È la soluzione ottimale per dare vita a vere e proprie linee di luce continue sulla parete e sul soffitto, creando scenografie sempre diverse. È fornita con schermo in policarbonato opale satinato ed è disponibile in tre lunghezze, due finiture e diverse temperature di colore.

^{EN} Linea 48 is a line of light to be mounted in the 48VDC low voltage electrified tracks. It is the best solution to create continuous lines of lights on the walls or in the ceiling, providing possibilities for a multitude of light scenes. It is provided with an opal frosted polycarbonate screen and it is available in three lengths, two body finishes and with different colour temperatures.

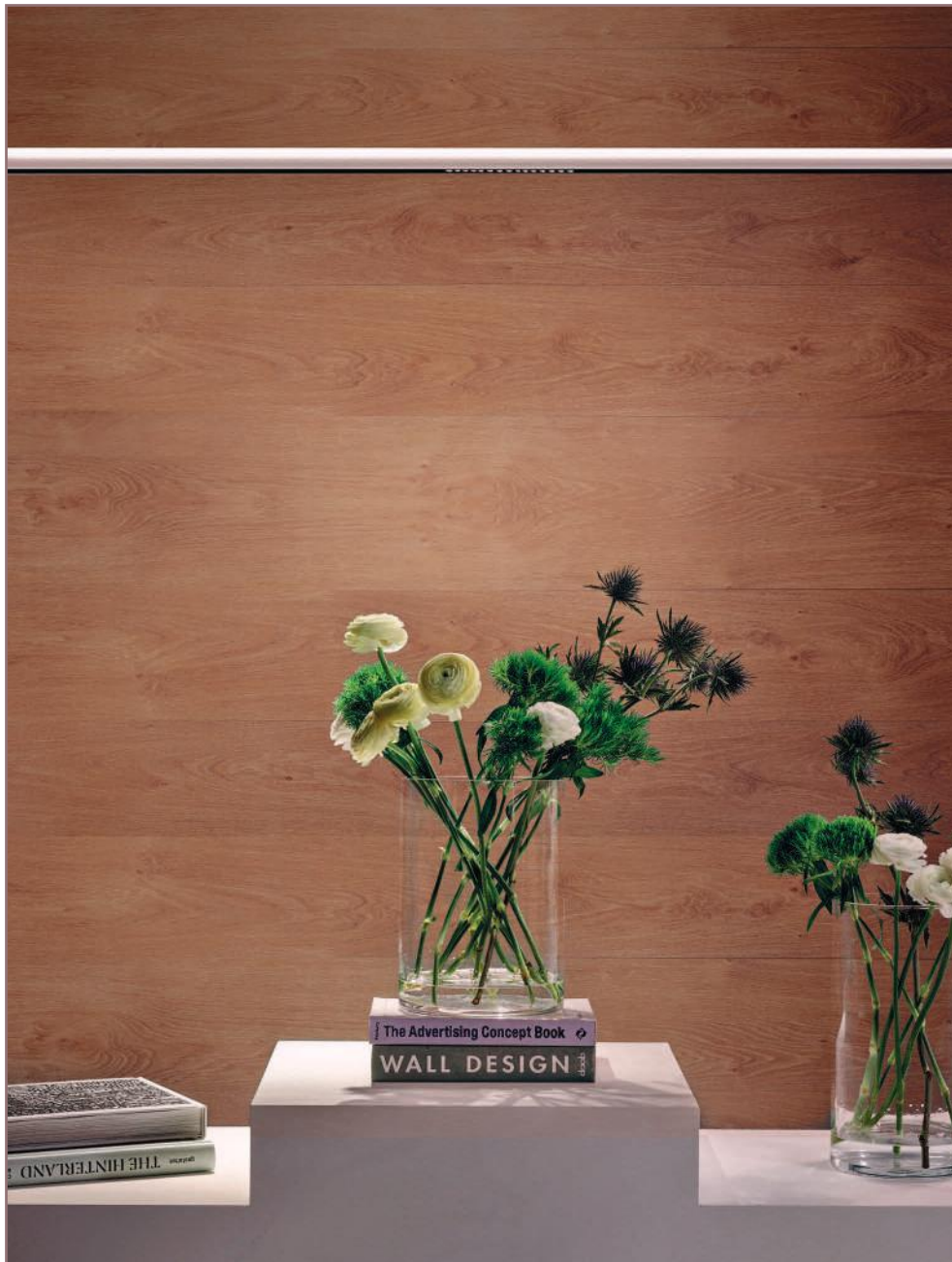

^{ITA} Minirooler, applicabile su binari 48VDC a bassa tensione e su 35 Track, è caratterizzato da una grande efficienza racchiusa in solo 14 mm di larghezza. Minirooler prevede 15 lenti in PMMA per differenti aperture, oltre alla possibilità di ottenere fasci asimmetrici. La quasi invisibilità delle sorgenti luminose all'interno dell'apparecchio focalizza l'attenzione sui dettagli dell'architettura e genera comfort visivo assoluto, senza abbagliamento.

^{EN} Minirooler can be mounted on 48Vdc low voltage tracks and on 35 Track. It features a high efficiency enshrined in only 14 mm length. Minirooler features 15 PMMA lenses that allow for different light beams also for asymmetric effects. The light sources are almost invisible within the fitting so that the attention is focused on the details of the architecture only, for a great visual comfort without glaring.





Kartell flagship store – Firenze (Kartell courtesy)

35 Track e proiettori Microperetto 48VDC in finitura bianco mat.
35 Track and Microperetto 48VDC track lights in mat white finish.



Kartell flagship store – Firenze (Kartell courtesy)

35 Track e proiettori Microperfetto 48VDC in finitura bianco mat.
35 Track and Microperfetto 48VDC track lights in mat white finish.



Installazione su 35 Track

35 Track installation

^{ITA} 35 Track permette l'integrazione delle famiglie di micro-proiettori e luci lineari caratterizzati da design minimale, basso abbagliamento e ottiche simmetriche ed asimmetriche. L'accensione uplight di 35 Track combinata con i fasci più stretti dei proiettori permette di ottenere effetti di luce flessibili.

^{EN} 35 Track allows the integration of families of micro-spotlights and linear lights characterized by minimal design, low glare, and symmetrical and asymmetrical optics. The uplight of 35 Track combined with the narrower beams of the spotlights gives life to flexible lighting effects.

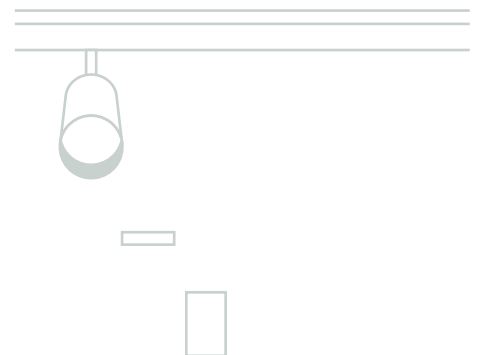









02

Punti

luci a binario 48V

48V track lights



	Products	Pages
	Minirooler 48V	238
	Linea 48V	239
	Nanoperfetto 48V	240
	Microperfetto Low 48V	240
	Microperfetto Large 48V	241
	Microperfetto Large Zoom 48V	241
	Binario 48V - quadro	242
	Binario 48V - incasso TL	243

MINIROOLER 48Vdc



30 Nero
Black

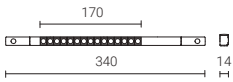

0.1 Kg

DALI

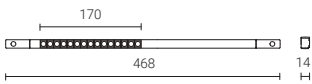

0.1 Kg

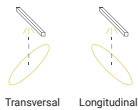

Codice base Base code	Colour T (K)	Fascio Beam	Controllo Control	Finitura Finish
Dimmerabile PWM per binari a bassa tensione 48Vdc - con 15 microlenti in PMMA / PWM dimmable for 48Vdc low-voltage electrified tracks with 15 PMMA microlenses.				
471-019	C 2700K	Z 12°	Z	-30
	B 3000K	Y 20°		
	A 4000K	W 50°		
		R 14°+41° transversal		
		Q 14°+41° longitudinal		

48Vdc



Caratteristiche illuminotecniche / Lighting specifications

Watt	LED Lumen	Product Lumen	Colour T	CRI
17	1650	1320	2700	90
	1650	1320	3000	90
	1650	1320	4000	90

Codice base Base code	Colour T (K)	Fascio Beam	Finitura Finish
Con driver DALI integrato - utilizzare con apposito trasformatore DALI / With integrated DALI driver - to be used with proper DALI transformer			
472-019	C 2700K	Z 12°	-30
	B 3000K	Y 20°	
	A 4000K	W 50°	
		R 14°+41° transversal	
		Q 14°+41° longitudinal	

Reference configurator

Il codice prodotto si compone mettendo in fila, da sinistra a destra, i dati contenuti nelle colonne a partire da "Codice base". Nel caso di proiettori PWM, la lettera Z per il controllo non è obbligatoria.

The product code is created by putting in sequence the data starting from "Base code", from left to right.

For PWM spotlights, the Z letter for control is not mandatory.

es: 471-019CWZ-30



31 Bianco mat / Mat white 30 Nero / Black

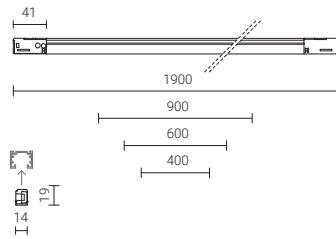

DALI

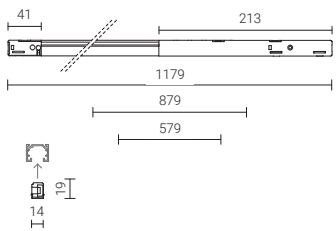

Codice Code	Lunghezza Length (mm)	LED Lumen	Product Lumen	Watt	Colour T (K)	CRI
-------------	-----------------------	-----------	---------------	------	--------------	-----

Dimmerabile PWM per binari a bassa tensione 48V_{dc} - con schermo in policarbonato opale satinato / PWM dimmable for 48V_{dc} low-voltage electrified tracks with opal frosted polycarbonate screen

470-009C04-	400	776	-	7,2	2700	90
470-00904-	400	776	-	7,2	3000	90
470-009A04-	400	776	-	7,2	4000	90
470-079C06-	600	1292	-	12	2700	90
470-07906-	600	1292	-	12	3000	90
470-079A06-	600	1292	-	12	4000	90
470-089C09-	900	2068	-	19	2700	90
470-08909-	900	2068	-	19	3000	90
470-089A09-	900	2068	-	19	4000	90
470-099C19-	1900	4653	-	43	2700	90
470-09919-	1900	4653	-	43	3000	90
470-099A19-	1900	4653	-	43	4000	90

Con sistema di controllo wireless remoto per binari a bassa tensione 48VDC - con schermo in policarbonato opale satinato / With wireless remote control system for 48VDC low-voltage electrified tracks with opal frosted polycarbonate screen

470-009CZ04-	400	776	-	7,2	2700	90
470-009Z04-	400	776	-	7,2	3000	90
470-009AZ04-	400	776	-	7,2	4000	90
470-079CZ06-	600	1292	-	12	2700	90
470-079Z06-	600	1292	-	12	3000	90
470-079AZ06-	600	1292	-	12	4000	90
470-089CZ09-	900	2068	-	19	2700	90
470-089Z09-	900	2068	-	19	3000	90
470-089AZ09-	900	2068	-	19	4000	90
470-099CZ19-	1900	4653	-	43	2700	90
470-099Z19-	1900	4653	-	43	3000	90
470-099AZ19-	1900	4653	-	43	4000	90

Con driver DALI integrato - utilizzare con apposito trasformatore DALI. Con schermo in policarbonato opale satinato / With integrated DALI driver - to be used with proper DALI transformer. With opal frosted polycarbonate screen

469-019C-	579	1220	-	7,5	2700	90
469-019B-	579	1220	-	7,5	3000	90
469-019A-	579	1220	-	7,5	4000	90
469-029C-	879	2441	-	15	2700	90
469-029B-	879	2441	-	15	3000	90
469-029A-	879	2441	-	15	4000	90
469-039C-	1179	3661	-	22,5	2700	90
469-039B-	1179	3661	-	22,5	3000	90
469-039A-	1179	3661	-	22,5	4000	90

48V_{dc}



NANOPERFETTO 48V_{DC}

CON LENTE / WITH LENS



21 **Bianco mat**
 Mat white
 16 **Nero**
Black
124 **Oro satinato**
Satin gold

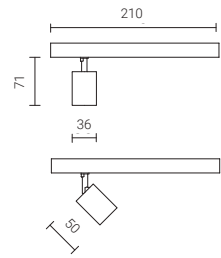

0,3 Kg

Codice base Base code	Colour T (K)	Fascio Beam	Controllo Control	Finitura Finish
--------------------------	-----------------	----------------	----------------------	--------------------

Dimmerabile PWM per binari a bassa tensione 48V_{DC} - con lente in PMMA / PWM dimmable for 48V_{DC} low-voltage electrified tracks with PMMA lens.

752-289	C 2700K	Z 21°	Z	-16
	B 3000K	W 38°		-21
	A 4000K	V 52°		-124
		R 15°+41°		

Codice base Base code	Colour T (K)	Fascio Beam	Finitura Finish
--------------------------	-----------------	----------------	--------------------

Sistema Dim to Warm / Dim to Warm system

752-1089	M 1800-2700K	Z 21°		-16
		W 38°		-21
		V 52°		-124
		R 15°+41°		

48V_{DC}

IP20

Caratteristiche illuminotecniche / Lighting specifications

Watt	LED Lumen	Product Lumen	Colour T	CRI	
5	494*	420	1800-2700 Dim to Warm	90	*Valore riferito alla massima dimmerazione Value referring to max dimming
7,3	675	581	2700	90	
	713	613	3000	90	
	763	656	4000	90	

Reference configurator

Il codice prodotto si compone mettendo in fila, da sinistra a destra, i dati contenuti nelle colonne a partire da "Codice base".

Nel caso di proiettori PWM, la lettera Z per il controllo non è obbligatoria.

The product code is created by putting in sequence the data starting from "Base code", from left to right.

For PWM spotlights, the Z letter for control is not mandatory.

es: 752-889BR-16

MICROPERFETTO LARGE 48V_{DC} CON LENTE / WITH LENS

Luci a binario 48V 48V track lights



21 Bianco mat
Mat white

16 Nero
Black

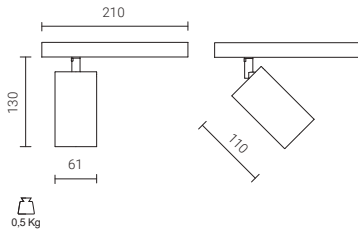

Codice base
Base code

Colour
T (K)

Fascio
Beam

Controllo
Control

Finitura
Finish

Dimmerabile PWM per binari elettrificati a bassa tensione
48V_{DC} - con lente in silicone / PWM dimmable for 48V_{DC}
low-voltage electrified tracks - with silicone lens

795-189 18,5W	C 2700K	Z 15°	Z	-16
	B 3000K	W 35°		-21
	A 4000K			

Codice base
Base code

Colour
T (K)

Fascio
Beam

Controllo
Control

Finitura
Finish

Dimmerabile PWM per binari elettrificati a bassa tensione
48V_{DC} - con lente in silicone / PWM dimmable for 48V_{DC}
low-voltage electrified tracks - with silicone lens

795-389 25W	C 2700K	Y 21°	Z	-16
	B 3000K	X 30°		-21
	A 4000K			

Codice base
Base code

Colour
T (K)

Fascio
Beam

Finitura
Finish

Dimmerabile DALI per binari elettrificati a bassa tensione
48V_{DC} - con lente in silicone / DALI dimmable for 48V_{DC}
low-voltage electrified tracks - with silicone lens

798-389 25W	C 2700K	Y 21°		-16
	B 3000K	X 30°		-21
	A 4000K			

48V_{DC}



Caratteristiche illuminotecniche / Lighting specifications

Watt	LED Lumen	Product Lumen	Colour T	CRI
18,5	1630	1386	2700	90
	1760	1496	3000	90
	1815	1543	4000	90
25	2650	2253	2700	90
	2760	2346	3000	90
	3179	2702	4000	90

MICROPERFETTO LARGE 48V_{DC} ZOOM



21 Bianco mat
Mat white

16 Nero
Black

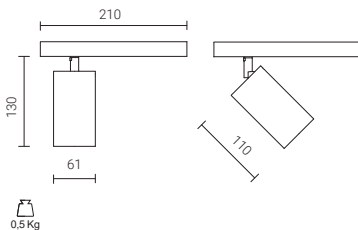

Codice base
Base code

Colour
T (K)

Controllo
Control

Finitura
Finish

Dimmerabile PWM per binari elettrificati a bassa tensione
48V_{DC} - con lente zoom regolabile in 7 posizioni / PWM
dimmable for 48V_{DC} low-voltage electrified tracks - with
zoom lens adjustable in 7 positions.

794-189 18,5W	C 2700K	Z	-16
	B 3000K		-21
	A 4000K		

Codice base
Base code

Colour
T (K)

Finitura
Finish

Dimmerabile DALI per binari elettrificati a bassa tensione
48V_{DC} - con lente zoom regolabile in 7 posizioni / DALI
dimmable for 48V_{DC} low-voltage electrified tracks - with
zoom lens adjustable in 7 positions.

797-189 18,5W	C 2700K		-16
	B 3000K		-21
	A 4000K		

Codice base
Base code

Colour
T (K)

Finitura
Finish

Sistema Dim to Warm - con lente zoom regolabile in
7 posizioni / Dim to Warm system - with zoom lens
adjustable in 7 positions.

797-049 12W	M 1800-2700K	-16
		-21

48V_{DC}



Caratteristiche illuminotecniche / Lighting specifications

Watt	LED Lumen	Product Lumen	Colour T (K)	CRI	Fascio Beam
12	1130*	757	1800-2700 Dim to Warm	90	18° to 46°
18,5	1630	1092	2700	90	13° to 47°
	1760	1174	3000	90	13° to 47°
	1815	1216	4000	90	13° to 47°

*Valore riferito alla massima dimmerazione
Value referring to max dimming

Zoom technology

La rotazione del cilindro interno
permette di modificare l'angolo
del fascio.

The rotation of the internal snoot
modifies the beam angle.

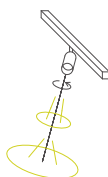

48V_{dc} QUADRO/SQUARE



Codice base Base code	Lunghezza Length (mm)	Finitura Finish
--------------------------	--------------------------	--------------------

Binari a bassa tensione / Low voltage tracks

6445-	10 1000mm	-16
	20 2000mm	-21
	30 3000mm	

48V_{dc} - 15A

21 Bianco mat
Mat white

16 Nero
Black

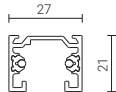

Per trasformatori e dispositivi di regolazione, vedi pagina accanto
For transformers, dimmers and controllers, see the following page

Accessori binario 48V_{dc} quadro / 48V_{dc} square track accessories

6453-00
Giunto lineare
Straight joint

30 31 25 850°

6454-10
Giunto lineare senza contatti
Mechanical joint without electrical contacts

30 31 25 850°

6455-10
Giunto L interno / Inside L joint

6455-11
Giunto L esterno / Outside L joint

30 31 5 850°

6464-10
Giunto T destro / Right T joint

6464-11
Giunto T sinistro / Left T joint

30 31 4 850°

6456-00
Giunto flessibile
Flexible joint

30 31 2 850°

6458-06 (2000 mm)
Kit sospensione con cavo acciaio, piattina e bloccacavo automatico
Suspension kit with steel wire, plate and automatic locking device

30 31 10 850°

6458-00 (2000 mm)
Kit sospensione con cavo acciaio e piattina / Suspension kit with steel wire and plate

30 31 10 850°

6459-20
Kit soffitto/parete a coppia
Wall/ceiling pair

30 31 10 850°

6463-00-00
Kit attacco soffitto
Ceiling kit

10 850°

6461-00 (1000 mm)
Copertura binario
Track cover

30 31 10 850°

6460-00
Chiusura
Dead end

30 31 10 850°

Alimentatori binario 48V_{dc} quadro / 48V_{dc} square track live-ends

6451-10
Alimentazione destra
Right live-end

30 31 10 850°

6451-11
Alimentazione sinistra
Left live-end

30 31 10 850°

6452-00
Alimentazione centrale
Central connector

30 31 5 850°

6503-10 (150W)
Alimentazione destra con trasformatore integrato
Right live-end with integrated transformer

30 31

6503-11 (150W)
Alimentazione sinistra con trasformatore integrato
Left live-end with integrated transformer

30 31

6506-00 (150W)
Alimentazione con trasformatore integrato per binario sospeso
Live-end with integrated transformer for suspended track

30 31

6504-10 (150W)
Alimentazione destra con trasformatore integrato DALI
Right live-end with integrated transformer DALI

30 31

6504-11 (150W)
Alimentazione sinistra con trasformatore integrato DALI
Left live-end with integrated transformer DALI

30 31

6507-00 (150W)
Alimentazione con trasformatore integrato per binario sospeso DALI
Live-end with integrated transformer for suspended track DALI

30 31

6505-10 (100W)
Alimentazione destra con trasformatore integrato
Right live-end with integrated transformer

30 31

6505-11 (100W)
Alimentazione sinistra con trasformatore integrato
Left live-end with integrated transformer

30 31

48V_{dc} INCASSO TL / TL RECESSED



Codice base Base code	Lunghezza Length (mm)	Finitura Finish
Binari a bassa tensione / Low voltage tracks		
6446-	10 1000mm	-30
	20 2000mm	-31
	30 3000mm	

48V_{dc} - 15A

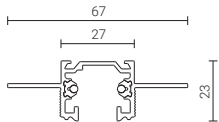

31 Bianco
White 30 Nero
Black



Accessori binario 48V_{dc} incasso / 48V_{dc} recessed track accessories

 6453-00 Giunto lineare Straight joint   	 6454-10 Giunto lineare senza contatti Mechanical joint without electrical contacts   	 6484-10 Giunto L interno Inside L joint   	 6484-11 Giunto L esterno Outside L joint   
 6457-00-00 (120 mm) Piattina (obbligatoria per la congiunzione di più binari) / Plate (compulsory for the connection between tracks)  	 6461-00 (1000 mm) Copertura binario Track cover   	 6483-00 Chiusura Dead end   	

Alimentatori binario 48V_{dc} incasso TL / 48V_{dc} TL recessed track transformers

 6480-10 Alimentazione destra Right live-end   	 6480-11 Alimentazione sinistra Left live-end   	 6481-00 Alimentazione centrale Central connection   
---	---	--

Trasformatori binario 48V_{dc} incasso TL 48V_{dc} TL recessed track transformers



- 81-09000**
Trasformatore PWM 100W 230V/48V per uso remoto
100W 230V/48V PWM transformer for remote use
- 81-09001**
Trasformatore PWM 200W 230V/48V per uso remoto
200W 230V/48V PWM transformer for remote use
- 81-90122**
Trasformatore PWM 300W 230V/48V per uso remoto
300W 230V/48V PWM transformer for remote use
- 6465-03-31**
Trasformatore elettronico 150W 220-240V/48V_{dc} DALI per uso remoto / 150W 220-240V/48VDC DALI electronic transformer for remote use

Dispositivi di regolazioni per trasformatori Dimmers and controllers for transformers



- 81-90089**
Dimmer Casambi Bluetooth 48V 4 canali
(per trasformatori cod. 81-09000, 81-09001, 81-90122)
Bluetooth Casambi dimmer 48V 4 channels
(for transformers codes 81-09000, 81-09001, 81-90122)
- 81-90124**
Dimmer DALI (per trasformatori cod. 81-09000, 81-09001, 81-90122)
DALI dimmer (for transformers codes 81-09000, 81-09001, 81-90122)
- 81-90123**
Dimmer PWM (per trasformatori cod. 81-09000, 81-09001, 81-90122)
PWM dimmer (for transformers codes 81-09000, 81-09001, 81-90122)
- 81-90128**
Controller Bluetooth DALI (per trasformatore cod. 6465-03-31)
Bluetooth DALI controller (for transformer code 6465-03-31)



03

Punti

luci a binario 230V

230V track lights

Linearità al servizio della creatività

Linearity at the service of creativity

^{ITA} I binari sono progettati per essere facilmente installati a soffitto, a parete oppure incassati, per l'utilizzo di proiettori o apparecchi a sospensione. La semplicità di installazione degli apparecchi consente di avere impianti di illuminazione facilmente modificabili senza la necessità di interventi tecnici onerosi, così da creare scenari dinamici adattabili ai diversi ambienti.

^{EN} Tracks are designed to be easily installed, either on or recessed into the ceiling or wall and for use with spotlights or with suspended fittings. This easy and quick installation allows modification of the lighting layout at any time, avoiding expensive works and providing a dynamic solution that can fit in many different spaces.



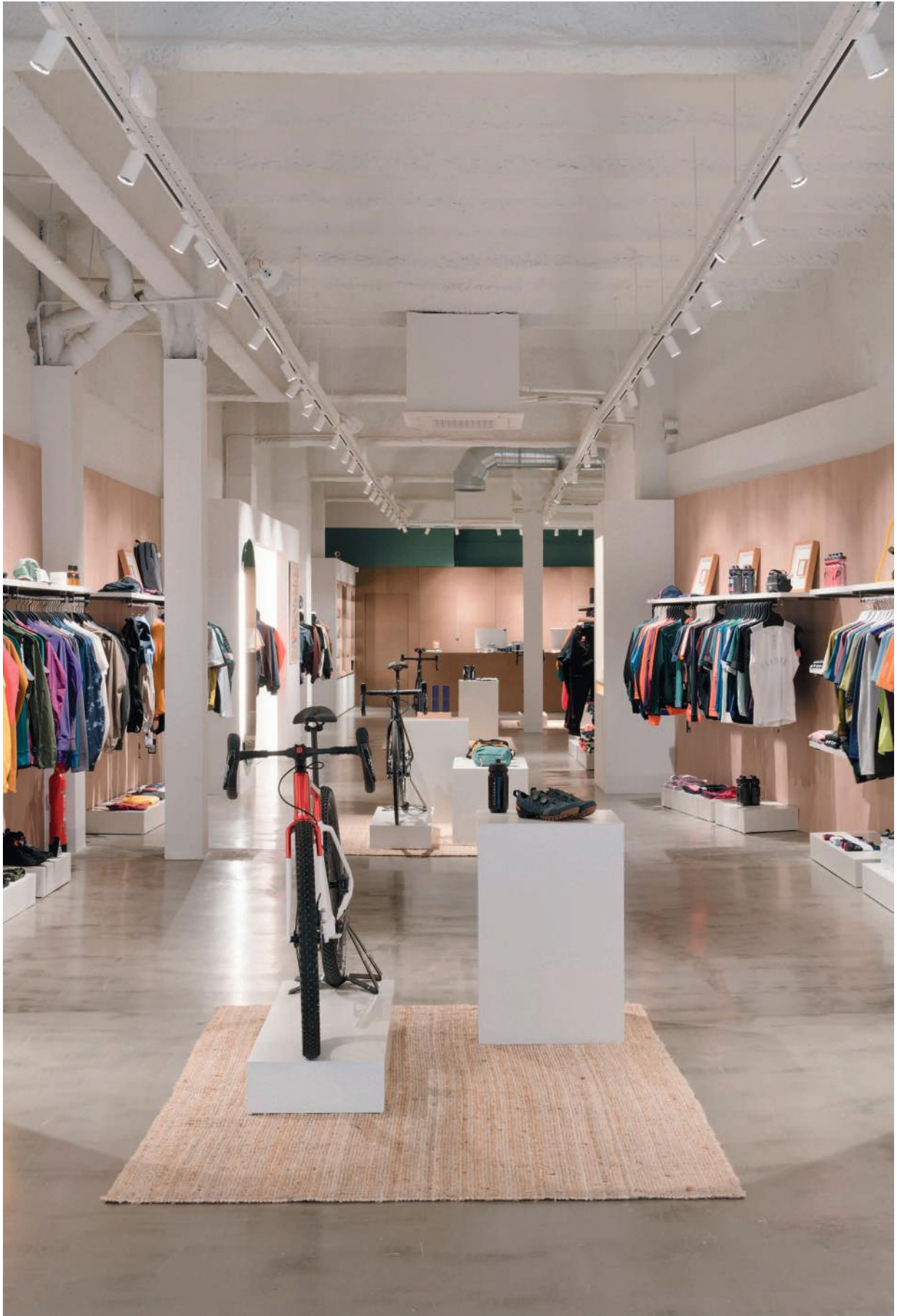

Velodrom CC store - Barcelona
(Photo: Mario Wurzbürger / Lights: Difusiona)





Velodrom CC store - Barcelona
(Photo: Mario Wurzbürger / Lights: Difusiona)



Brass Monkey - Dubai
Lighting project: Skyelume

Estetica essenziale per luce d'accento

Essential design for accent light

^{ITA} Proiettori LKM, come Perfetto Puro e la gamma dei Microperfetto Large, sono ideali per quei contesti, come il retail, dove un elevato apporto di luce è caratteristica che può fare la differenza. In ambienti di questo tipo, infatti, ciò che è necessario valorizzare non è solo lo store, come nel caso dei progetti negli scatti, ma anche i prodotti esposti che, ovviamente, acquistano maggior valore per il cliente se esaltati dalla giusta luce.

^{EN} LKM spotlights, such as Perfetto Puro and the Microperfetto Large range are ideal for retail contexts where a high amount of light is a feature that can make the difference. In fact, in these spaces, not only the store should be promoted, but also the displayed products that obviously acquire a greater value for the customer if enhanced by the right light.



Brass Monkey - Dubai
Lighting project: Skyelume

DKM DIMMERABILE / DKM DIMMABLE

^{ITA} I binari DKM monofase permettono di gestire una varietà di applicazioni per la programmazione luminosa (DALI, DMX, 1-10V). Questa tecnologia consente, oltre a un consistente risparmio energetico, la possibilità di dar vita a scenografie luminose per ambienti espositivi, spazi polifunzionali e centri commerciali.

^{EN} The DKM tracks are applicable with the main systems in use to control light (DALI, DMX, 1-10V). This technology generates significant economies in terms of energy saving and it is ideal for exhibition areas, shopping and multifunctional centres.



Quadro / Square

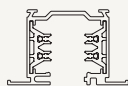

Incasso / Recessed



LKM TRIFASE / LKM THREE-PHASE

^{ITA} Light Kit Main è un sistema di binari trifase per tre circuiti elettrici separati. Le tre varianti di sezione, tonda, quadra o da incasso, permettono un utilizzo in molteplici ambienti.

^{EN} Light Kit Main is a three-phase track system with 3 separate circuits. Three different designs (round, square or recessed) make the system highly versatile for a wide range of applications.

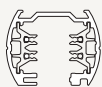

Tondo / Round



Quadro / Square

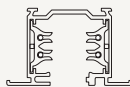

Incasso / Recessed





Fred Perry Flagship Store – Milano
Perfetto Puro LKM



Fred Perry Flagship Store – Milano
Perfetto Puro LKM

DKM

^{ITA} Il binario monofase dimmerabile DKM è disponibile in differenti lunghezze per applicazioni a plafone, a sospensione e a incasso. Il binario DKM è idoneo per l'applicazione dei principali sistemi di programmazione luminosa (DALI, DMX, 1-10V). Alimentazione alla rete monofase 230-250V, carico complessivo di 16A corrispondente a 3680/4000W. Sono disponibili proiettori con driver DALI e appositi adattatori per binari dimmerabili DKM.

^{EN} The single-phase dimmable track DKM is available in different lengths for installation on the ceiling, suspended or recessed. The DKM track is applicable with the main systems in use to control light (DALI, DMX, 1-10V). Connection to single phase 230-250V mains, total load of 16A corresponding to 3680/4000W. Spotlights including DALI drivers and specific adapters are available for DKM dimmable tracks.



ITA LUCE DINAMICA

La possibilità di gestire, da un sistema remoto, l'intensità dei flussi luminosi di ogni singolo punto luce in modo indipendente consente un elevato livello di personalizzazione e di valorizzazione delle aree espositive. I sistemi di controllo dell'illuminazione consentono un reale miglioramento dell'efficienza energetica e permettono di creare scenografie della luce in diverse applicazioni, quali ambienti espositivi, musei, centri commerciali.

EN DYNAMIC LIGHT

Remote light control for the variation of the light intensity of each fitting in an independent way allows both a high level of customization and the right emphasis in exhibition areas. Light control systems make it possible to achieve real improvements in terms of energetic efficiency and to create scenic effects with light for different applications such as exhibition areas, museums, shopping centres.

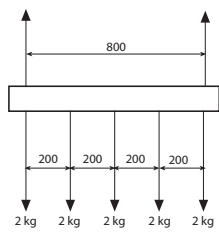

**CAPACITÀ DI CARICO
LOAD CAPACITY**

ITA Il binario può sopportare un carico di 2 Kg ogni 200 mm. Nel caso di carico di 10 Kg ogni 200 mm, la distanza di fissaggio deve essere di 400 mm.

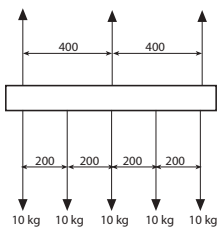

EN The track has a load capacity of 2 Kg every 200 mm. In case of 10 Kg load every 200 mm, a distance of 400 mm between the fixing point is recommended.



ITA SCHEMA ELETTRICO

Il collegamento alla rete elettrica monofase 230/250V consente un carico complessivo di 16A che corrisponde a 3680/4000 Watt.

EN WIRING DIAGRAM

Connection to single phase 230/250V mains allows a total load of 16A corresponding to 3680/4000W.

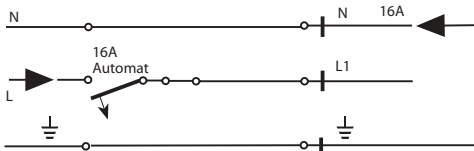

ITA ACCESSORI

Il binario DKM é corredato da una serie di accessori dedicati (adattatore e connettori di alimentazione), e di altri in comune con il sistema quadro LKM. É obbligatorio l'uso dello specifico adattatore elettromeccanico cod. 7559.

EN ACCESSORIES

The DKM track system includes a range of specific accessories such as an adapter and live-ends, together with a set of other accessories, that are in common with the LKM square system. The use of the specific electro-mechanic adapter code 7559 is compulsory.



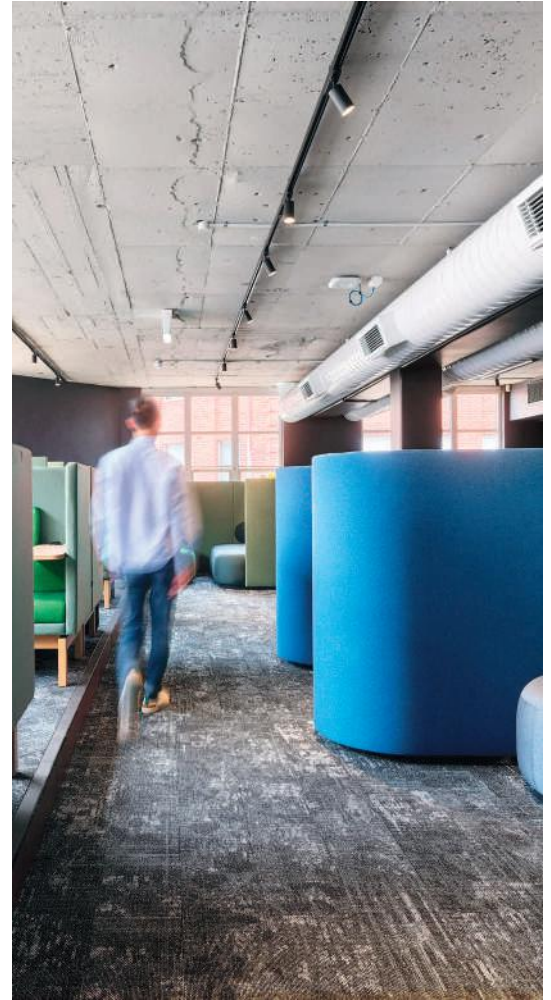

University of Notre Dame, Prindiville Hall – Fremantle (Australia)
 Interior design: Actus Associates
 Lights: Inlite
 Photo: DMax Photography

LKM

^{ITA} Accensioni, disponibile in quattro lunghezze per applicazioni a plafone e a sospensione. Le differenti versioni, da appoggio o da incasso, soddisfano ogni esigenza di installazione. La completezza degli accessori rende LKM ideale nella progettazione illuminotecnica per flessibilità e versatilità. Tensione di rete 230/250V. Tensione di rete industriale 380/440V. Carico complessivo 16A.

^{EN} Light Kit Main is a system of three-phase tracks with three circuits, available in 4 different lengths for installation on the ceiling or on the wall. The range, which also includes recessed tracks, is suitable for several installation needs. The complete range of accessories makes LKM extremely flexible and versatile in lighting design. Power supply 230/250V. Industrial power supply 380/440V. Total load 16A.

Tipologie di binari

Il binario trifase LKM è disponibile in tre versioni: a sezione tonda e quadra. La versione da incasso è dotata di due alette laterali che permettono l'appoggio su controsoffitti o pannellature.

Track version

The three-phase LKM track is available in 3 designs: round or square shaped. The recessed one is supplied with two side wings, to allow installation in false ceilings and panels.

ITA SCHEMI ELETTRICI

Il collegamento a una rete elettrica monofase 230/250V consente un carico complessivo di 16A, che corrisponde a 3680/4000 Watt suddivisibile su tre circuiti. Il collegamento alla rete elettrica trifase 230/400V consente un carico complessivo di 16A, che corrisponde a 11040 Watt ripartibili su tre circuiti (3x3680 Watt).

EN WIRING DIAGRAMS

The connections to a single phase 230/250V mains allows a total load of 16A, corresponding to 3680/4000 Watt, which can be divided among 3 circuits. The connection to a three-phase 230/400V electricity mains allows a total load of 16A, corresponding to 11040 Watt, which can be divided among 3 circuits (3x3680 Watt).

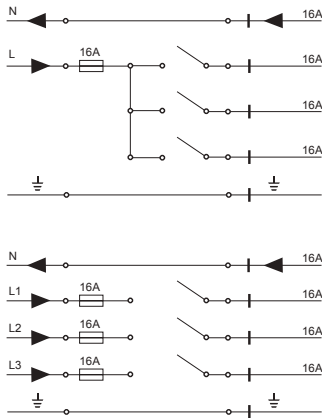

ITA CAPACITÀ DI CARICO

I binari trifase LKM possono sopportare un carico di 2 Kg ogni 200 mm con una distanza massima fra i punti di fissaggio di 800 mm. Nel caso di carico di 10 Kg ogni 200 mm, la distanza di fissaggio deve essere di 400 mm.

EN LOAD CAPACITY

LKM three-phase tracks have a load capacity of 2 Kg every 200 mm, with a maximum distance of 800 mm between the fixing point. For a 10 Kg load every 200 mm, a maximum fixing distance of 400 mm is recommended.

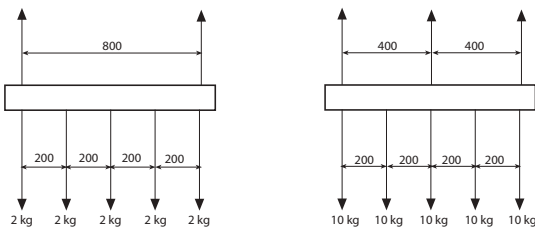

Continuità della messa a terra (vista in planimetria dall'alto)
Continuity of the earthing (top plan view)

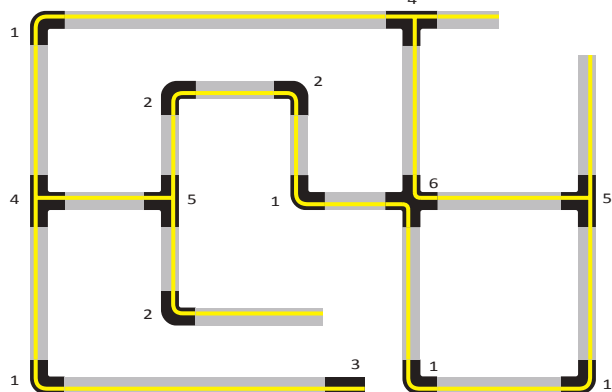
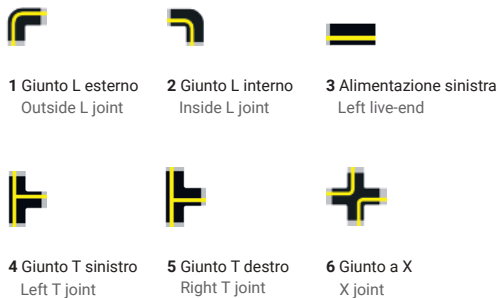

ITA CONTINUITÀ DELLA MESSA A TERRA

Per una corretta installazione di tutti gli accessori che concorrono alla formazione di un impianto di binari trifase, ha grande importanza la continuità della linea a terra tra ogni elemento. Il posizionamento dei conduttori di terra, infatti, deve essere consequenziale tra componente e componente.

EN CONTINUITY OF THE EARTHING

For a correct installation of all the accessories in a three-phase track composition, the continuity of the earthing between each element has the highest importance. The earth conductors of each component must be positioned consistently.



Conduttore di terra con alimentazione sinistra L

Conduttore di terra con alimentazione destra R

Live-end with earth on the left L

Live-end with earth on the right R









03

Punti

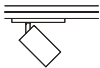
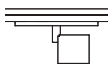
luci a binario 230V

230V track lights



	Products	Pages
	Microperfetto Large LKM con lente	258
	Microperfetto Large LKM	260
	Microperfetto Large Zoom LKM	260
	Perfetto Puro LKM	261
	Binario LKM - tondo / round	262
	Binario LKM - quadro / square	263
	Binario LKM - incasso / recessed	265
	Binario DKM - quadro / square	266
	Binario DKM - incasso / recessed	267

MICROPERFETTO LARGE LKM

CON LENTE / WITH LENS



21 Bianco mat
Mat white

16 Nero
Black

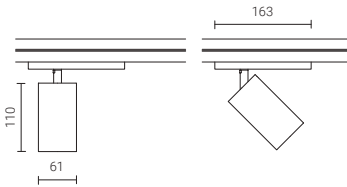

0,5 Kg

DALI

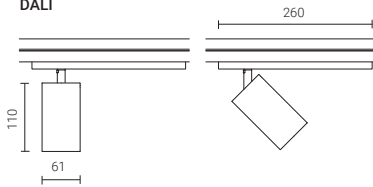

0,5 Kg

Codice base Base code	Colour T (K)	Fascio Beam	Controllo Control	Finitura Finish
--------------------------	-----------------	----------------	----------------------	--------------------

Per binari elettrificati trifase LKM - con lente in silicone
For LKM three-phase electrified tracks - with silicone lens

779-169 18,5W	C 2700K	Z 15°	Z	-16
	B 3000K	W 35°		-21
	A 4000K			

Codice base Base code	Colour T (K)	Fascio Beam	Finitura Finish
--------------------------	-----------------	----------------	--------------------

Con driver DALI - per binari dimmerabili DKM con apposito adattatore - con lente in silicone / With DALI driver - for DKM dimmable tracks with proper adapter - with silicone lens

782-169 18,5W	C 2700K	Z 15°	-16
	B 3000K	W 35°	-21
	A 4000K		

Codice base Base code	Colour T (K)	Fascio Beam	Controllo Control	Finitura Finish
--------------------------	-----------------	----------------	----------------------	--------------------

Per binari elettrificati trifase LKM - con lente in silicone
For LKM three-phase electrified tracks - with silicone lens

779-269 29W	C 2700K	Y 21°	Z	-16
	B 3000K	X 30°		-21
	A 4000K			

Codice base Base code	Colour T (K)	Fascio Beam	Finitura Finish
--------------------------	-----------------	----------------	--------------------

Con driver DALI - per binari dimmerabili DKM con apposito adattatore - con lente in silicone / With DALI driver - for DKM dimmable tracks with proper adapter - with silicone lens

782-269 29W	C 2700K	Y 21°	-16
	B 3000K	X 30°	-21
	A 4000K		

220/240V - 50/60Hz

CE IP20

Caratteristiche illuminotecniche / Lighting specifications

Watt	LED Lumen	Product Lumen	Colour T	CRI
18,5	1630	1386	2700	90
	1760	1496	3000	90
	1815	1543	4000	90
29	2980	2533	2700	90
	3100	2635	3000	90
	3566	3031	4000	90

Reference configurator

Il codice prodotto si compone mettendo in fila, da sinistra a destra, i dati contenuti nelle colonne a partire da "Codice base".

Nel caso di proiettori non DALI, la lettera Z per il controllo non è obbligatoria.

The product code is created by putting in sequence the data starting from "Base code", from left to right.

For non DALI spotlights, the Z letter for control is not mandatory.

es: 779-269AYZ-21



21 Bianco mat / Mat white 16 Nero / Black

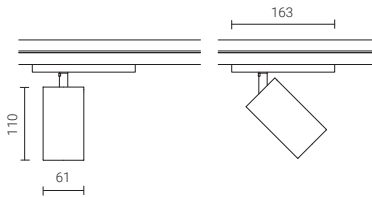

0.5 Kg

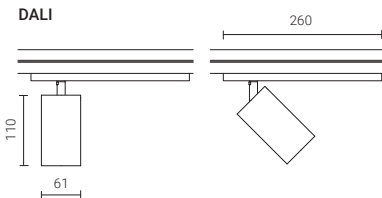

0.5 Kg

Codice base Base code	Colour T (K)	Fascio Beam	Controllo Control	Finitura Finish
Per binari elettrificati trifase LKM For LKM three-phase electrified tracks				
780-369 25W	C 2700K	Y 20°	Z	-16
	B 3000K	X 30°		-21
	A 4000K	W 42°		

Codice base Base code	Colour T (K)	Fascio Beam	Controllo Control	Finitura Finish
Per binari elettrificati trifase LKM For LKM three-phase electrified tracks				
780-269 29W	C 2700K	Y 20°	Z	-16
	B 3000K	X 30°		-21
	A 4000K	W 42°		

Codice base Base code	Colour T (K)	Fascio Beam	Finitura Finish
Con driver DALI - per binari dimmerabili DKM con apposito adattatore / With DALI driver - for DKM dimmable tracks with proper adapter			
783-269 29W	C 2700K	Y 20°	-16
	B 3000K	X 30°	-21
	A 4000K	W 42°	

220/240V - 50/60Hz



Caratteristiche illuminotecniche / Lighting specifications

Watt	LED Lumen	Product Lumen	Colour T	CRI
25	2650	2120	2700	90
	2760	2208	3000	90
	3179	2543	4000	90
29	2980	2384	2700	90
	3100	2480	3000	90
	3566	3067	4000	90

Reference configurator

Il codice prodotto si compone mettendo in fila, da sinistra a destra, i dati contenuti nelle colonne a partire da "Codice base". Nel caso di proiettori non DALI, la lettera Z per il controllo non è obbligatoria.

The product code is created by putting in sequence the data starting from "Base code", from left to right.

For non DALI spotlights, the Z letter for control is not mandatory.

es: 783-269CW-16

Accessori ottici intercambiabili / Replaceable optical accessories

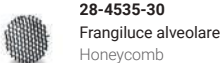

28-4535-30
Frangiluce alveolare
Honeycomb



28-4534-47
Vetro zigrinato
Prismatic spread lens

MICROPERFETTO LARGE LKM

ZOOM - 13° to 47°



21 **Bianco mat**
Mat white

16 **Nero**
Black

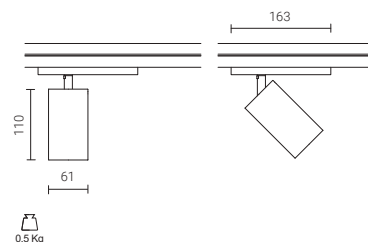

0,5 Kg

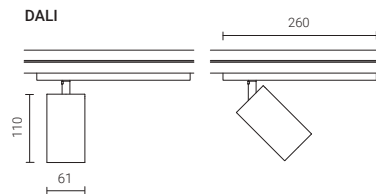

0,5 Kg

Codice base	Colour	Controllo	Finitura
Base code	T (K)	Control	Finish

Per binari elettrificati trifase LKM - con lente zoom regolabile in 7 posizioni / For LKM three-phase electrified tracks - with zoom lens adjustable in 7 positions

778-169 18,5W	C 2700K	Z	-16
	B 3000K		-21
	A 4000K		

Codice base	Colour	Finitura
Base code	T (K)	Finish

Con driver DALI - per binari dimmerabili DKM con apposito adattatore / With DALI driver - for DKM dimmable tracks with proper adapter

781-169 18,5W	C 2700K	-16
	B 3000K	-21
	A 4000K	

220/240V - 50/60Hz

CE IP20

Caratteristiche illuminotecniche / Lighting specifications

Watt	LED Lumen	Product Lumen	Colour T	CRI
18,5	1630	1092	2700	90
	1760	1174	3000	90
	1815	1216	4000	90

Zoom technology

La rotazione del cilindro interno permette di modificare l'angolo del fascio da 13° a 47°.

The rotation of the internal snoot modifies the beam angle from 13° to 47°.

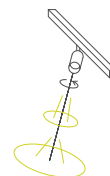

Reference configurator

Il codice prodotto si compone mettendo in fila, da sinistra a destra, i dati contenuti nelle colonne a partire da "Codice base".

Nel caso di proiettori non DALI, la lettera Z per il controllo non è obbligatoria.

The product code is created by putting in sequence the data starting from "Base code", from left to right.

For non DALI spotlights, the Z letter for control is not mandatory.

es: 778-169BZ-21



21 Bianco mat
Mat white

16 Nero
Black

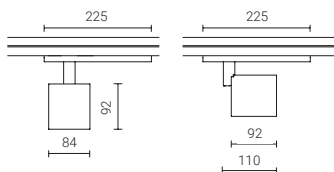

0,9Kg

Codice base	Colour	Fascio	Finitura
Base code	T (K)	Beam	Finish

Con driver DALI - per binari dimmerabili DKM con apposito adattatore / With DALI driver - for DKM dimmable tracks with proper adapter

771-069 32W	B 3000K	Z 17°	-16
		X 30°	-21
		V 55°	
		T 70°	

Codice base	Colour	Fascio	Finitura
Base code	T (K)	Beam	Finish

Con driver DALI - per binari dimmerabili DKM con apposito adattatore / With DALI driver - for DKM dimmable tracks with proper adapter

771-261 32W	A 4000K	Z 17°	-16
		X 30°	-21
		V 55°	
		T 70°	

Codice base	Colour	Fascio	Finitura
Base code	T (K)	Beam	Finish

Per binari elettrificati trifase LKM
For LKM three-phase electrified tracks

770-269 37W	B 3000K	Z 17°	-16
		A 4000K	-21
		V 55°	
		T 70°	

220/240V - 50/60Hz

CE IP20

Caratteristiche illuminotecniche / Lighting specifications

Watt	LED Lumen	Product Lumen	Colour T	CRI
32	3830	3409	3000	90
	4500	4005	4000	90
37	4400	3916	3000	90
	5119	4556	4000	90

Reference configurator

Il codice prodotto si compone mettendo in fila, da sinistra a destra, i dati contenuti nelle colonne a partire da "Codice base".

The product code is created by putting in sequence the data starting from "Base code", from left to right.

es: 770-269AX-16

Accessori ottici intercambiabili / Replaceable optical accessories



28-3957-30
Cilindro antiabbagliamento
Snoot



28-3959-30
Frangiluce alveolare (da utilizzare insieme a snoot cod. 28-3957-30)
Honeycomb (to be used with snoot code 28-3957-30)

LKM
TONDO / ROUND



Codice base Base code	Lunghezza Length (mm)	Finitura Finish
Binario LKM trifase tondo / LKM 3-phase round track		
7501-	10 1000mm	-30
	20 2000mm	-31
	30 3000mm	
230/440V-16A		

31 Bianco White 30 Nero Black

CE IP20

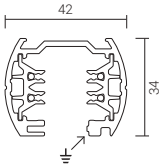

Adattatore e alimentatori / Adapter and live-ends

7600-00 (portata / load 10kg)
Adattatore elettromeccanico 6A
Electro/mechanical adapter 6A

30 31 8

7558-00 (portata / load 5kg)
Adattatore elettromeccanico 6A
Electro/mechanical adapter 6A

30 31 10

7557-00 (200-700mA 8,8-31W, load 5kg)
Adattatore elettromeccanico con driver elettronico integrato 220/240V
Electro/mechanical adapter with integrated electronic driver 220/240V

30 31 1

7602-10-W
Alimentazione destra
Right live-end

30 31 10

7602-11-W
Alimentazione sinistra
Left live-end

30 31 10

7603-10-W
Alimentazione centrale e giunto lineare / Central connector and straight joint

30 31 2

Accessori LKM tondo / Round LKM accessories

7605-10-W
Giunto L interno
Inside L joint

30 31 4

7605-11-W
Giunto L esterno
Outside L joint

30 31 4

7621-10-W
Giunto T destro
Right T joint

30 31 2

7621-11-W
Giunto T sinistro
Left T joint

30 31 2

7622-10-W
Giunto X
X joint

30 31 2

7610-10-W
Giunto flessibile
Flexible joint

30 31 2

7604T-10-W
Giunto lineare elettrificato con contatti e con blocco
Electrical straight joint with stop

30 31 6

7625-00
Adattatore meccanico
Mechanical adapter

30 31 10

7618-00 (2000 mm)
Adattatore meccanico con bloccacavo e cavo acciaio
Mechanical adapter with automatic locking and steel wire

30 31 10

7606-05 (2000 mm)
Kit sospensione con cavo acciaio e piastrina 120 mm / Suspension kit with steel wire and 120 mm plate

30 31 10

7606-06 (2000 mm)
Kit sospensione con cavo acciaio, piastrina 60 mm e bloccacavo automatico
Suspension kit with steel wire, 60 mm plate and automatic locking device

30 31 10

7606-00 (2000 mm)
Kit sospensione con cavo acciaio e piastrina 60 mm / Suspension kit with steel wire and 60 mm plate

30 31 10

7626-00-00 (1000 mm)
Kit sospensione con tige e rosone traslucido / Suspension kit with pipe and translucent ceiling base

30 31 4

7623-00-W
Terminale di chiusura
Dead end

30 31 10

7606-04-00 (120 mm)
Piastrina
Plate

30 31 50

7609-00-00
Raccordo per adattatore elettromeccanico M10x1 / Nut for electro/mechanical adapter M10x1

30 31 10

7607-00-00
Kit attacco soffitto
Ceiling kit

30 31 10

7624-00 (1000 mm)
Copertura binario
Track cover

30 31 10



Codice base Base code	Lunghezza Length (mm)	Finitura Finish
Binario LKM trifase quadrato / LKM 3-phase square track		
7511-	10 1000mm	-30
	20 2000mm	-31
	30 3000mm	-42
	40 4000mm	
230/440V-16A		

31 Bianco White 30 Nero Black 42 Anodizzato naturale Satin silver

CE IP20

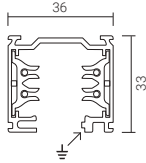

Adattatore e alimentatori / Adapter and live-ends

7600-00 (portata / load 10kg)
Adattatore elettromeccanico 6A
Electro/mechanical adapter 6A



30 31 20 8

7558-00 (portata / load 5kg)
Adattatore elettromeccanico 6A
Electro/mechanical adapter 6A



30 31 20 10

7557-00 (200-700mA 8,8-31W, load 5kg)
Adattatore elettromeccanico con driver elettronico integrato 220/240V
Electro/mechanical adapter with integrated electronic driver 220/240V



30 31 20 1

7652-10-W
Alimentazione destra
Right live-end



30 31 20 10

7652-11-W
Alimentazione sinistra
Left live-end



30 31 20 10

7653-10-W
Alimentazione centrale e giunto lineare
Central connector and straight joint



30 31 20 2

Accessori LKM quadro / Square LKM accessories

7655-10-W
Giunto L interno / Inside L joint



7655-11-W
Giunto L esterno / Outside L joint



30 31 20 4

7656-10-W
Giunto T destro / Right T joint



7656-11-W
Giunto T sinistro / Left T joint



30 31 20 2

7657-10-W
Giunto X
X joint



30 31 20 2

7658-10-W
Giunto flessibile
Flexible joint



30 31 20 2

7660-00-W
Giunto mobile
Mobile joint



30 31 20 4

7604Q-10-W
Giunto lineare elettrificato con contatti e blocco / Electrical straight joint with stop



30 31 6

7654-10-W
Giunto lineare con blocco senza contatti (solo meccanico) / Mechanical straight joint with stop without electrical contacts

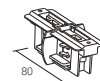

30 31 6

7625-00
Adattatore meccanico
Mechanical adapter



30 31 52 10

7618-00 (2000 mm)
Adattatore meccanico con bloccacavo e cavo acciaio
Mechanical adapter with automatic locking and steel wire



30 31 10

7606-05 (2000 mm)
Kit sospensione con cavo acciaio e piastrina 120 mm / Suspension kit with steel wire and 120 mm plate



30 31 10

7606-06 (2000 mm)
Kit sospensione con cavo acciaio, piastrina 60 mm e bloccacavo automatico
Suspension kit with steel wire, 60 mm plate and automatic locking device



30 31 10

7606-00 (2000 mm)
Kit sospensione con cavo acciaio e piastrina 60 mm / Suspension kit with steel wire and 60 mm plate



30 31 10

7626-00-00 (1000 mm)
Kit sospensione con tige e rosone traslucido / Suspension kit with pipe and translucent ceiling base



4

7659-00-W
Terminale di chiusura
Dead end



30 31 20 10

7606-04-00 (120 mm)
Piastrina
Plate



50

7609-00-00
Raccordo per adattatore elettromeccanico M10x1 / Nut for electro/mechanical adapter M10x1



10

7607-00-00
Kit attacco soffitto
Ceiling kit



10

7624-00 (1000 mm)
Copertura binario
Track cover



30 31 10



Velodrom CC store - Barcelona
(Photo: Mario Wurzbürger / Lights: Difusiona)



Codice base Base code	Lunghezza Length (mm)	Finitura Finish
Binario trifase LKM da incasso / LKM 3-phase recessed track		
7512-	10 1000mm	-30
	20 2000mm	-31
	30 3000mm	
	40 4000mm	
230/440V-16A		

31 Bianco White 30 Nero Black

CE IP20

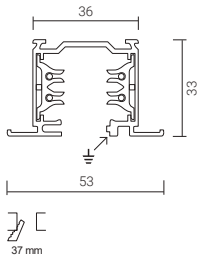

Adattatore e alimentatori / Adapter and live-ends

 <p>7600-00 (portata / load 10kg) Adattatore elettromeccanico 6A Electro/mechanical adapter 6A</p> <p>30 31 8 </p>	 <p>7558-00 (portata / load 5kg) Adattatore elettromeccanico 6A Electro/mechanical adapter 6A</p> <p>30 31 10 </p>	 <p>7557-00 (200-700mA 8,8-31W, load 5kg) Adattatore elettromeccanico con driver elettronico integrato 220/240V Electro/mechanical adapter with integrated electronic driver 220/240V</p> <p>30 31 1 </p>	 <p>7662-10-W Alimentazione destra Right live-end</p> <p>30 31 10 </p>
 <p>7662-11-W Alimentazione sinistra Left live-end</p> <p>30 31 10 </p>	 <p>7663-10-W Alimentazione centrale e giunto lineare / Central connector and straight joint</p> <p>30 31 2 </p>		

Accessori LKM incasso / Recessed LKM accessories

 <p>7604-10-W Giunto lineare elettrificato con contatti / Electrical straight joint</p> <p>30 31 6 </p>	 <p>7654-10-W Giunto lineare con blocco senza contatti (solo meccanico) Mechanical straight joint with stop without electrical contacts</p> <p>30 31 6 </p>	 <p>7625-00 Adattatore meccanico Mechanical adapter</p> <p>30 31 10 </p>	 <p>7618-00 (2000 mm) Adattatore meccanico con bloccacavo e cavo acciaio Mechanical adapter with automatic locking and steel wire</p> <p>30 31 10 </p>
 <p>7606-06 (2000 mm) Kit sospensione con cavo acciaio, piastrina 60 mm e bloccacavo automatico Suspension kit with steel wire, 60 mm plate and automatic locking device</p> <p>30 31 10 </p>	 <p>7606-00 (2000 mm) Kit sospensione con cavo acciaio e piastrina 60 mm / Suspension kit with steel wire and 60 mm plate</p> <p>30 31 10 </p>	 <p>7664-00-48 Sospensione per controsoffitto Suspension for false ceiling</p> <p>30 31 10 </p>	 <p>76591-00-W Terminale di chiusura Dead end</p> <p>30 31 10 </p>
 <p>7609-00-00 Raccordo per adattatore elettromeccanico M10x1 / Nut for electro/mechanical adapter M10x1</p> <p>30 31 10 </p>	 <p>7607-00-00 Kit attacco soffitto Ceiling kit</p> <p>30 31 10 </p>	 <p>7624-00 (1000 mm) Copertura binario Track cover</p> <p>30 31 10 </p>	

DKM

QUADRO / SQUARE



Codice base Base code	Lunghezza Length (mm)	Finitura Finish
Binario monofase DKM dimmerabile quadro DKM single-phase square dimmable tracks		
7520-	10 1000mm	-30
	20 2000mm	-31
	30 3000mm	
	40 4000mm	
230/250V - 16A		

31 Bianco White 30 Nero Black

CE $\approx 850^\circ$ IP20

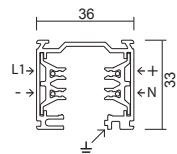

Adattatore e alimentatori / Adapter and live-ends

7559-00 (portata / load 10kg)
Adattatore elettromeccanico
DALI 6A / DALI electro/mechanical adapter 6A

30 31 10 $\approx 850^\circ$

7651-10-W
Alimentazione destra
Right live-end

30 31 10 $\approx 850^\circ$

7651-11-W
Alimentazione sinistra
Left live-end

30 31 10 $\approx 850^\circ$

7661-10-W
Alimentazione centrale e giunto lineare / Central connector and straight joint

30 31 2 $\approx 850^\circ$

Accessori DKM / DKM accessories

7655-10-W
Giunto L interno / Inside L joint

30 31 4 $\approx 850^\circ$

7655-11-W
Giunto L esterno / Outside L joint

30 31 4 $\approx 850^\circ$

7656-10-W
Giunto T destro / Right T joint

30 31 2 $\approx 850^\circ$

7656-11-W
Giunto T sinistro / Left T joint

30 31 2 $\approx 850^\circ$

7657-10-W
Giunto X
X joint

30 31 2 $\approx 850^\circ$

7658-10-W
Giunto flessibile
Flexible joint

30 31 2 $\approx 850^\circ$

7660-00-W
Giunto mobile
Mobile joint

30 31 4 $\approx 850^\circ$

7604Q-10-W
Giunto lineare elettrificato con contatti e blocco / Electrical joint with stop

30 31 6 $\approx 850^\circ$

7654-10-W
Giunto lineare con blocco senza contatti (solo meccanico)
Mechanical straight joint with stop without electrical contacts

30 31 6 $\approx 850^\circ$

7625-00
Adattatore meccanico
Mechanical adapter

30 31 10 $\approx 850^\circ$

7618-00 (2000 mm)
Adattatore meccanico con bloccacavo e cavo acciaio
Mechanical adapter with automatic locking and steel wire

30 31 10 $\approx 850^\circ$

7606-05 (2000 mm)
Kit sospensione con cavo acciaio e piastrina 120 mm / Suspension kit with steel wire and 120 mm plate

30 31 10 $\approx 850^\circ$

7606-06 (2000 mm)
Kit sospensione con cavo acciaio, piastrina 60 mm e bloccacavo automatico
Suspension kit with steel wire, 60 mm plate and automatic locking device

30 31 10 $\approx 850^\circ$

7606-00 (2000 mm)
Kit sospensione con cavo acciaio e piastrina 60 mm / Suspension kit with steel wire and 60 mm plate

30 31 10 $\approx 850^\circ$

7626-00-00 (1000 mm)
Kit sospensione con tige e rosone traslucido / Suspension kit with pipe and translucent ceiling base

30 31 4 $\approx 850^\circ$

7659-00-W
Terminale di chiusura
Dead end

30 31 10 $\approx 850^\circ$

7606-04-00 (120 mm)
Piattina
Plate

30 31 50

7609-00-00
Raccordo per adattatore elettromeccanico M10x1 / Nut for electro/mechanical adapter M10x1

30 31 10 $\approx 850^\circ$

7607-00-00
Kit attacco soffitto
Ceiling kit

30 31 10 $\approx 850^\circ$

7624-00 (1000 mm)
Copertura binario
Track cover

30 31 10 $\approx 850^\circ$





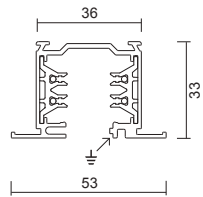

Codice base Base code	Lunghezza Length (mm)	Finitura Finish
Binario monofase DKM dimmerabile quadro DKM single-phase square dimmable tracks		
7521-	20 2000mm	-30
	30 3000mm	-31

230/250V - 16A

31 Bianco White 30 Nero Black



Adattatore e alimentatori / Adapter and live-ends

 <p>7559-00 (portata / load 10kg) Adattatore elettromeccanico DALI 6A / DALI electro/mechanical adapter 6A</p> <p>30 31 10 850°</p>	 <p>7665-10-W Alimentazione destra Right live-end</p> <p>30 31 8 850°</p>	 <p>7665-11-W Alimentazione sinistra Left live-end</p> <p>30 31 8 850°</p>	 <p>7666-10-W Alimentazione centrale e giunto lineare Central connector and straight joint</p> <p>30 31 2 850°</p>
--	---	--	--

Accessori DKM incasso / Recessed DKM accessories

 <p>7604-10-W Giunto lineare elettrificato con contatti / Electrical straight joint</p> <p>30 31 6 850°</p>	 <p>7654-10-W Giunto lineare con blocco senza contatti (solo meccanico) / Mechanical straight joint with stop without electrical contacts</p> <p>30 31 6 850°</p>	 <p>7625-00 Adattatore meccanico Mechanical adapter</p> <p>30 31 10 850°</p>	 <p>7618-00 (2000 mm) Adattatore meccanico con bloccacavo e cavo acciaio Mechanical adapter with automatic locking and steel wire</p> <p>30 31 10 850°</p>
 <p>7664-00-48 Sospensione per controsoffitto Suspension for false ceiling</p> <p>10 850°</p>	 <p>76591-00-W Terminale di chiusura Dead end</p> <p>30 31 10 850°</p>	 <p>7609-00-00 Raccordo per adattatore elettromeccanico M10x1 / Nut for electro/mechanical adapter M10x1</p> <p>10 850°</p>	 <p>7607-00-00 Kit attacco soffitto Ceiling kit</p> <p>10 850°</p>
 <p>7624-00 (1000 mm) Copertura binario Track cover</p> <p>30 31 10 850°</p>			



04

Punti

luci da parete e plafone

wall / ceiling lights

Il design al centro della scena

The design takes center stage

^{ITA} I prodotti della gamma di luci da parete e plafone rappresentano l'ibrido perfetto tra vintage e modernità. Tutta la serie è caratterizzata da un profilo particolarmente sottile e da forme geometriche essenziali quali il cerchio e il rettangolo, che le consentono di essere collocata in spazi anche con altezze ridotte, a soffitto o a parete, in ambiti sia residenziali che pubblici. Prodotti versatili che fanno della semplicità di installazione un punto di forza fondamentale.

^{EN} The products in the range of wall and ceiling lights represent the perfect hybrid between vintage and modernity. The whole series features a very shallow profile and minimal geometric shapes such as the circle and the rectangle, which allow it to be placed in spaces even with reduced heights, on the ceiling or wall, in both residential and public settings. Versatile products that make installation simplicity a fundamental strength.



Minirooler Base (1:1 size)



Minirooler Base in finitura nera o rame spazzolato (dettaglio a sinistra)
Minirooler Base in black or brushed copper finish (detail, on the left)



Concepito per il benessere visivo

Designed for visual well-being

^{ITA} Minirooler Base rappresenta a tutti gli effetti la rivoluzione del comfort visivo non solo in termini di performance illuminotecnica, ma anche di adattamento allo spazio architettonico. Un lingotto di pura luce dove la personalizzazione della finitura estetica lo rende all'occorrenza minimale o protagonista negli spazi. Integrato mimeticamente nei soffitti o esaltato nelle sue caratteristiche di finiture materiche esclusive si pone come una nuova visione di sistema declinabile in alte performance illuminotecniche e di qualità visiva.

^{EN} Minirooler Base is a revolution in visual comfort, not only in terms of lighting performance but also in adaptation to architectural space. A line of pure light where the customization of the finish makes it minimalist or protagonist in spaces when needed. Camouflaged into ceilings or enhanced with its exclusive material finish features, it can be considered a new vision of the lighting system which declines high lighting performance and visual quality.



Distribuzione luminosa morbida e pulita.

Smooth and clean light distribution.

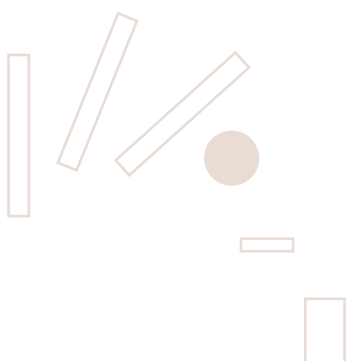

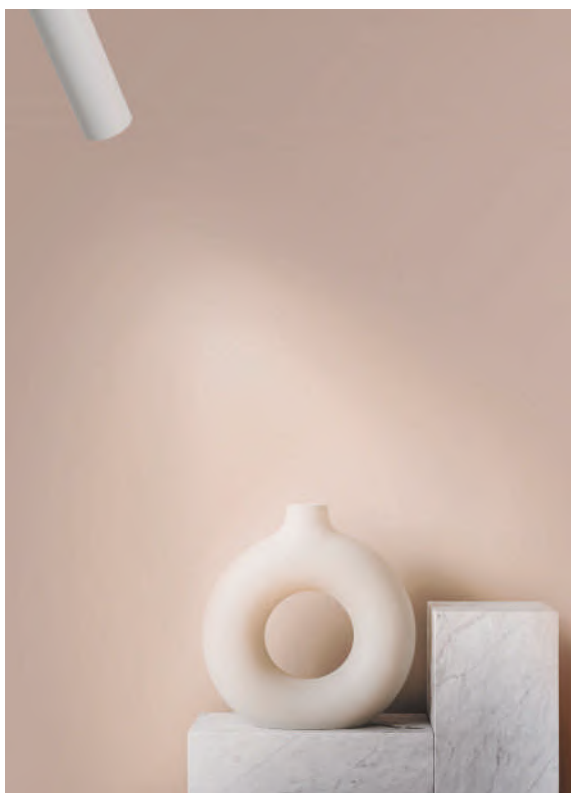

ITA Miniperfetto Base è sinonimo di versatilità: un design, molteplici applicazioni, per offrire soluzioni illuminotecniche personalizzate e flessibili, ideali per ogni esigenza progettuale.

EN Miniperfetto Base is synonymous with versatility: one design, multiple applications, for customized and flexible lighting solutions, ideal for every design requirement.



Esprimi la tua personalità

Express your personality

Private residence - Neuilly-sur-Seine (a sinistra / on the left)
Interior & Lighting Design: SLAM Architects

Brentano Hub - Milano (in alto / above)
JRK Design

Private residence - Roma (a destra / on the left)



04

Punti

luci da parete e plafone

wall / ceiling lights



	Products	Pages
	Minirooler Base 10 luci	276
	Minirooler Base 15 luci	277
	Nanoperfetto Base	278
	Microperfetto Large Base Zoom	280
	Miniperfetto Base	281

MINIROOLER BASE

10 LUCI / 10 LIGHTS

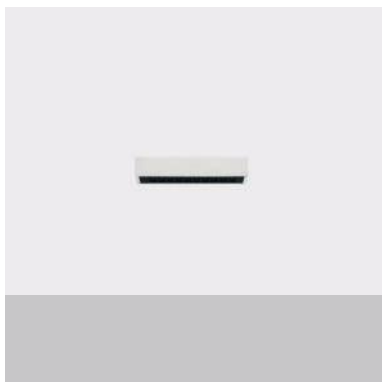

21 Bianco mat / Mat white 16 Nero / Black 88 Rame spazzolato / Brushed copper

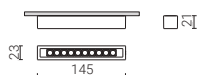

0,1 Kg



Codice base Base code	Colour T (K)	Fascio Beam	No driver	Finitura Finish
--------------------------	-----------------	----------------	-----------	--------------------

Fisso con 10 microlenti in PMMA, per applicazione a superficie
Fixed with 10 PMMA microlenses, for surface application

3898-019	C 2700K	Z 12°	N	-16
	B 3000K	Y 20°		-21
	A 4000K	V 50°	Q 14°+41° longitudinal	-88

CE 850° IP40

Caratteristiche illuminotecniche / Lighting specifications

Watt	mA	LED Lumen	Product Lumen	Colour T (K)	CRI
10,4	350	1100	880	2700	90
		1100	880	3000	90
		1100	880	4000	90

Driver da ordinare separatamente / Driver to be ordered separately

- 81-04010** Output 350mA - max 1 apparecchio / max 1 fitting
Regolabile sul taglio di fase / Dimmable on the mains
- 81-04003** Output 350mA - max 3 apparecchi / max 3 fittings
Dimmerabile DALI, 1-10V, Push / DALI dimmable, 1-10V, Push
- 81-04090** Output 350mA
Wireless Bluetooth

Reference configurator

Il codice prodotto si compone mettendo in fila, da sinistra a destra, i dati contenuti nelle colonne a partire da "Codice base".

The product code is created by putting in sequence the data starting from "Base code", from left to right.

es: 3898-019BVN-88

MINIROOLER BASE

15 LUCI / 15 LIGHTS

Luci da parete e plafone

Wall / ceiling lights

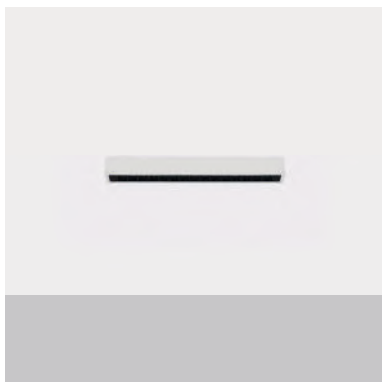

21 Bianco mat / Mat white 16 Nero / Black 88 Rame spazzolato / Brushed copper

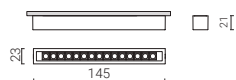

0,1 Kg



Codice base Base code	Colour T (K)	Fascio Beam	No driver	Finitura Finish
--------------------------	-----------------	----------------	-----------	--------------------

Fisso con 15 microlenti in PMMA, per applicazione a superficie
Fixed with 15 PMMA microlenses, for surface application

3896-019	C 2700K	Z 12°	N	-16
	B 3000K	Y 20°		-21
	A 4000K	V 50°		-88
		Q 14°+41° longitudinal		

CE 850° IP40

Caratteristiche illuminotecniche / Lighting specifications

Watt	mA	LED Lumen	Product Lumen	Colour T (K)	CRI
15,5	350	1650	1320	2700	90
		1650	1320	3000	90
		1650	1320	4000	90

Driver da ordinare separatamente / Driver to be ordered separately

81-02464	Output 350mA - max 1 apparecchio / max 1 fitting Regolabile sul taglio di fase / Dimmable on the mains
81-04003	Output 350mA - max 1 apparecchio / max 1 fitting Dimmerabile DALI, 1-10V, Push / DALI dimmable, 1-10V, Push

Reference configurator

Il codice prodotto si compone mettendo in fila, da sinistra a destra, i dati contenuti nelle colonne a partire da "Codice base".

The product code is created by putting in sequence the data starting from "Base code", from left to right.

es: 3896-019CZN-21

NANOPERFETTO BASE



21 Bianco mat
Mat white

16 Nero
Black

0G Oro satinato
Satin gold

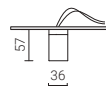

0,1 Kg

Codice base
Base code

Colour
T (K)

Fascio
Beam

No driver

Finitura
Finish

Fisso con lente in PMMA e base per applicazione a superficie
Fixed with PMMA lens and base for surface application

752-729	C 2700K	Y 21°	N0	-16
	B 3000K	W 38°		-21
	M 1800-2700K	V 52°		-0G
		R 15°+41°		

Codice base
Base code

Colour
T (K)

Fascio
Beam

No driver

Finitura
Finish

Sistema Dim to Warm / Dim to Warm system

752-929	M 1800-2700K	Y 21°	N0	-16
		W 38°		-21
		V 52°		-0G
		R 15°+41°		

CE IP40

Caratteristiche illuminotecniche / Lighting specifications

Watt	mA	LED Lumen	Product Lumen	Colour T (K)	CRI
5	300	494*	420	1800-2700 Dim to Warm	90
6	500	579	498	2700	90
		611	525	3000	90

*Valore riferito alla massima dimmerazione
Value referring to max dimming

Driver da ordinare separatamente / Driver should be ordered separately

81-04029 Output 500mA
Regolabile sul taglio di fase / Dimmable on the mains

81-04026 Output 500mA
Dimmerabile DALI / DALI dimmable

81-04087 Output 500mA
Wireless Bluetooth

81-04075 Output 300mA
Dimmerabile sulla fase / Dimmable on the mains

81-04074 Output 300mA
Dimmerabile DALI / DALI dimmable

81-04072 Output 300mA
Dimmerabile 1-10V / 1-10V dimmable

81-04089 Output 300mA
Wireless Bluetooth

Reference configurator

Il codice prodotto si compone mettendo in fila, da sinistra a destra, i dati contenuti nelle colonne a partire da "Codice base".

The product code is created by putting in sequence the data starting from "Base code", from left to right.

es: 752-729BRN0-0G

Accessori ottici intercambiabili / Replaceable optical accessories



28-4499-30
Frangilucente alveolare
Honeycomb



Nanoperfetto Base (1:1 size)

MICROPERFETTO LARGE BASE

ZOOM - 13° to 47°



21 **Bianco mat** / Mat white
16 **Nero** / Black

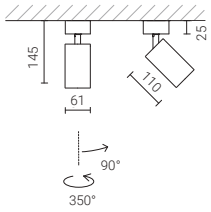

0,5kg

Codice base Base code	Colour T (K)	No driver	Finitura Finish
--------------------------	-----------------	-----------	--------------------

Con lente zoom regolabile in 7 posizioni e basetta per applicazione a superficie / With zoom lens adjustable in 7 positions and base for surface application

784-129	C 2700K	N	-16
	B 3000K		-21
	A 4000K		

CE IP20

Caratteristiche illuminotecniche / Lighting specifications

Watt	mA	LED Lumen	Product Lumen	Colour T (K)	CRI
18,5	500	1216	1034	2700	90
		1310	1114	3000	90
		1815	1216	4000	90

Driver da ordinare separatamente / Driver should be ordered separately

81-04011	Output 500mA
81-04002	Output 500mA Dimmerabile DALI / DALI dimmable
81-04092	Output 500mA Wireless Bluetooth

Zoom technology

La rotazione del cilindro interno permette di modificare l'angolo del fascio da 13° a 47°.

The rotation of the internal snoot modifies the beam angle from 13° to 47°.

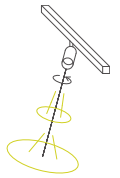

Reference configurator

Il codice prodotto si compone mettendo in fila, da sinistra a destra, i dati contenuti nelle colonne a partire da "Codice base".

The product code is created by putting in sequence the data starting from "Base code", from left to right.

es: **784-129CN-16**



Codice base Base code	Colour T (K)	Fascio Beam	Finitura Finish
--------------------------	-----------------	----------------	--------------------

Con basetta per applicazione a superficie, con driver integrato
With base for surface application, with integrated driver

748-129	C 2700K	Y 24°	-16
	B 3000K	V 45°	-21
	A 4000K		

Regolabile sulla fase / Dimmable on the mains
220/240V - 50/60Hz

CE IP20

21 Bianco mat
Mat white

16 Nero
Black

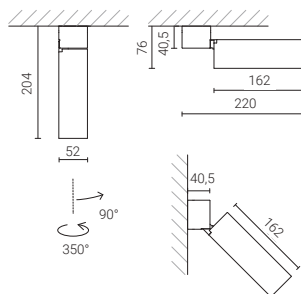

0,6 Kg

Caratteristiche illuminotecniche / Lighting specifications

Watt	LED Lumen	Product Lumen	Colour T (K)	CRI
9	1100	915	2700	90
	1170	972	3000	90
	1241	1030	4000	90

Reference configurator

Il codice prodotto si compone mettendo in fila, da sinistra a destra, i dati contenuti nelle colonne a partire da "Codice base".

The product code is created by putting in sequence the data starting from "Base code", from left to right.

es: 748-129AV-21

Accessori ottici intercambiabili / Replaceable optical accessories



28-3979-100
Cilindro oro satinato
Satinated gold baffle



28-4536-30
Frangiluce alveolare
Honeycomb



05

Punti

sospensioni

pendants

Minimalismo ed eleganza

Minimal and elegant

^{ITA} Sottili fili in tessuto sospendono in aria i corpi luminosi. Di grande effetto scenografico, i punti luce sono forme leggere e lineari da cui fuoriesce la giusta luce per creare accenti e atmosfere. Ideali in abbinamento ad altri apparecchi, per soluzioni architettoniche formali e funzionali allo stesso tempo.

^{EN} Thin fabric wires suspend the luminous bodies in the air. The pendant design is made to be minimalistic, linear shapes for a great visual effect, providing both accent and atmosphere lighting. Ideal in combination with other fittings, to meet both formal and functional demands.





Brentano Hub - Milano (JRK Design)
Miniperfetto-S



JRK Design Showroom – Geneve

Miniperfetto-S custom version



^{ITA} Miniperfetto-S è l'elegante versione a sospensione della gamma di proiettori Miniperfetto. Consente soluzioni illuminotecniche su misura, ideali per ogni esigenza progettuale. Le ottiche arretrate e lo snoot di serie riducono al minimo l'abbagliamento.

Il suo design, dalle linee compatte e dalla sottile testa cilindrica, si inserisce facilmente in numerosi contesti, dal retail, all'hospitality, al residenziale.

^{EN} Miniperfetto-S is the elegant suspended version of the Miniperfetto spotlight range. It allows customized lighting solutions, ideal for every design requirement. The retracted optics and the standard snoot reduce glare to a minimum.

Its design, with solid lines and a thin cylindrical head, fits easily into numerous contexts, from retail to hospitality to residential.

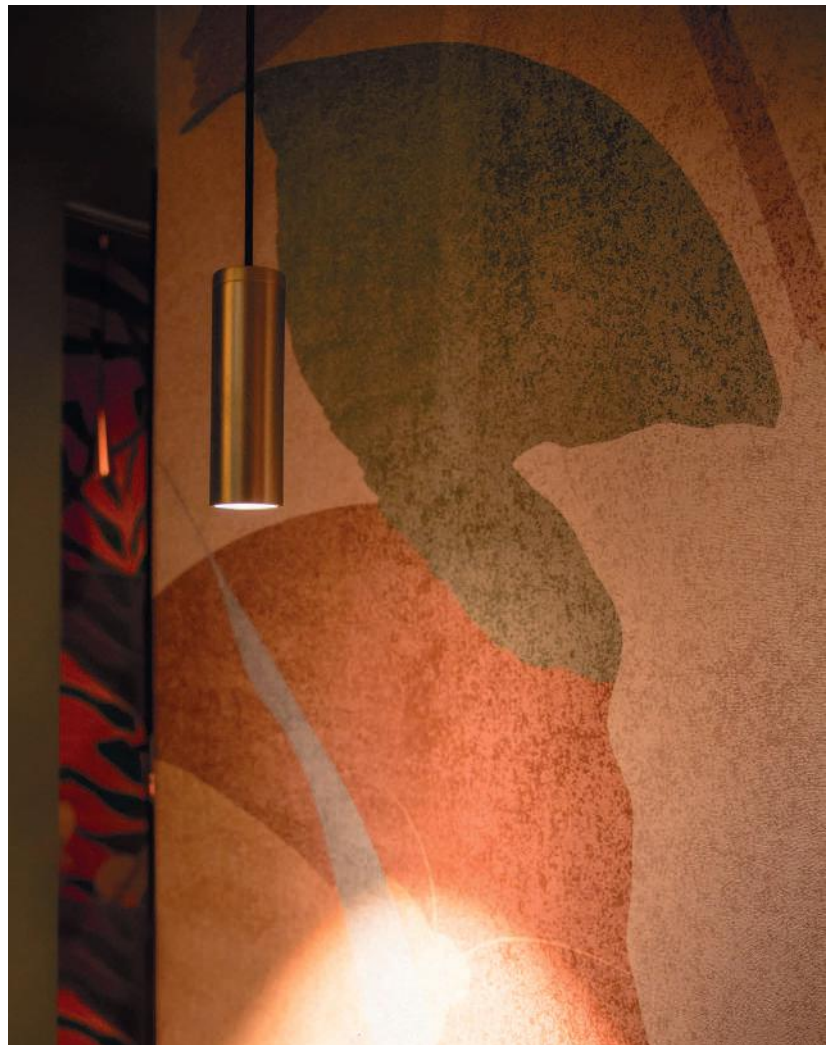



^{ITA} Nanoperfetto-S è una sospensione ideale in abbinamento ad altri apparecchi dal medesimo design. Miniaturizzato e quasi impercettibile è un prodotto integrabile in ogni contesto ambientale. Progettati con sorgenti LED COB ad alta efficienza luminosa, sono ideali sia come singolo punto luce, sia in composizione multipla. Le ottiche arretrate e lo snoot di serie consentono un elevato comfort visivo. Nanoperfetto-S si installa nel controsoffitto grazie all'apposito rosone.

^{EN} Nanoperfetto-S is a tiny suspension ideal when combined with other luminaries with a similar design. It can be integrated into any space thanks to its miniaturized and almost imperceptible shape. Designed with high luminous efficiency COB LED sources, it is ideal as a single light point and as multiple compositions. The rearward optics and the standard snoot allow a high visual comfort. Nanoperfetto-S has a canopy for installation in false ceilings.



Nanoperfetto-S + Linea 48Vdc

05





Punti

sospensioni

pendants



Iconica con rosone custom
Iconica with custom canopy

	Products	Pages
	Nanoperfetto-S	290
	Miniperfetto-S	291
	Perfetto Compact-S	291
	Iconica	292

NANOPERFETTO - S



21 **Bianco mat** / Mat white 16 **Nero** / Black 124 **Oro satinato** / Satin gold

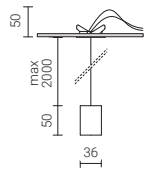

h 50 mm Ø 42 mm 0,4 Kg

Reference configurator

Il codice prodotto si compone mettendo in fila, da sinistra a destra, i dati contenuti nelle colonne a partire da "Codice base".

The product code is created by putting in sequence the data starting from "Base code", from left to right.

es: 752-219CYN-124

Codice base Base code	Colour T (K)	Fascio Beam	No driver	Finitura Finish
--------------------------	-----------------	----------------	-----------	--------------------

Con rosone per installazione a incasso in controsoffitto
With canopy for recessed installation in a false ceiling

752-219	C 2700K	Y 26°	N	-16
	B 3000K	W 34°		-21
		V 54°		-124

CE 85° IP20

Caratteristiche illuminotecniche / Lighting specifications

Watt	mA	LED Lumen	Product Lumen	Colour T (K)	CRI
3,5	350	340	222	2700	90
		355	248	3000	90
4,5	500	470	307	2700	90
		490	343	3000	90
6,5	700	620	405	2700	90
		650	425	3000	90

Driver da ordinare separatamente / Driver should be ordered separately

81-02408 Output 350mA

81-04029 Output 500mA
Regolabile sul taglio di fase / Dimmable on the mains

81-04027 Output 700mA
Regolabile sul taglio di fase / Dimmable on the mains

81-04028 Output 700mA*
Dimmerabile DALI / DALI dimmable

*Per una corretta installazione, considerare una profondità di incasso a soffitto di 200 mm
For a correct installation, please consider a ceiling recessed depth of 200 mm

81-04088 Output 700mA
Wireless Bluetooth

Accessori ottici intercambiabili / Replaceable optical accessories



28-4175-100
Cilindro oro satinato
Satined gold baffle



28-4200-30
Frangiluce alveolare
Honeycomb

MINIPERFETTO - S

Sospensioni

Pendants



21 Bianco mat
Mat white

16 Nero
Black

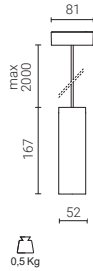

Codice base Base code	Colour T (K)	Fascio Beam	Finitura Finish
Con rosone per installazione a soffitto. Regolabile sulla fase With canopy for ceiling application. Dimmable on the mains			
748-219 9W	C 2700K	Y 24°	-16
	B 3000K	V 45°	-21
	A 4000K		

Codice base Base code	Colour T (K)	Fascio Beam	Finitura Finish
Con rosone per installazione a soffitto With canopy for ceiling application			
748-119 12W	C 2700K	Y 24°	-16
	B 3000K	V 45°	-21
	A 4000K		

220/240V - 50/60Hz

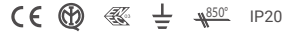

Caratteristiche illuminotecniche / Lighting specifications

Watt	LED Lumen	Product Lumen	Colour T (K)	CRI
9	1078	895	2700	90
	1148	953	3000	90
	1241	1030	4000	90
12	1478	1227	2700	90
	1574	1306	3000	90
	1702	1413	4000	90

PERFETTO COMPACT - S



21 Bianco mat
Mat white

16 Nero
Black

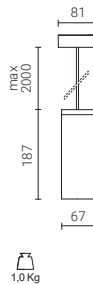

Codice base Base code	Colour T (K)	Fascio Beam	Finitura Finish
Con rosone per installazione a soffitto With canopy for ceiling application			
751-219	C 2700K	Y 20°	-16
	B 3000K	X 29°	-21
	A 4000K	W 42°	

220/240V - 50/60Hz



Caratteristiche illuminotecniche / Lighting specifications

Watt	LED Lumen	Product Lumen	Colour T (K)	CRI
26	2760	2007	2700	90
	2940	2146	3000	90
	3179	2321	4000	90

Accessori ottici intercambiabili solo per Miniperfetto - S
Replaceable optical accessories only for Miniperfetto - S



28-3979-100
Cilindro oro satinato
Satined gold baffle



28-4536-30
Frangiluce alveolare
Honeycomb

Accessori ottici intercambiabili solo per Perfetto Compact - S
Replaceable optical accessories only for Perfetto Compact - S



28-9004-30
Cilindro antiabbagliamento
Snoot



28-4080-30
Frangiluce alveolare (da utilizzare insieme
a snoot cod. 28-9004-30)
Honeycomb (to be used with snoot code
28-9004-30)



28-3905-47
Schermo di chiusura in
termoplastico trasparente
Closing screen in clear
thermoplastic material

ICONICA



- 21 **Bianco mat**
Mat white
- 16 **Nero**
Black
- 88 **Rame spazzolato**
Brushed copper

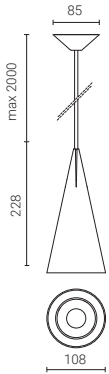

1,3 Kg

Reference configurator

Il codice prodotto si compone mettendo in fila, da sinistra a destra, i dati contenuti nelle colonne a partire da "Codice base".

The product code is created by putting in sequence the data starting from "Base code", from left to right.

es: **3920-02BX-88**

Codice base Base code	Colour T (K)	Fascio Beam	Finitura Finish
--------------------------	-----------------	----------------	--------------------

Con rosone per installazione a soffitto. Con driver integrato 230V
With canopy for ceiling application. With 230V integrated driver

3920-02 12W	C 2700K	Z 12°	-16
	B 3000K	X 30°	-21
	A 4000K	V 55°	-88
		T 70°	

Regolabile sulla fase / Dimmable on the mains

220/240V - 50/60Hz



Codice base Base code	Colour T (K)	Fascio Beam	No driver	Finitura Finish
--------------------------	-----------------	----------------	-----------	--------------------

Con rosone per installazione a soffitto. Driver da ordinare separatamente
With canopy for ceiling application. Driver should be ordered separately

3922-02 26W	C 2700K	Z 12°	N	-16
	B 3000K	X 30°		-21
	A 4000K	V 55°		-88
		T 70°		



Caratteristiche illuminotecniche / Lighting specifications

Watt	V / mA	LED Lumen	Product Lumen	Colour T (K)	CRI
12	230V	1478	1227	2700	90
		1574	1306	3000	90
		1702	1413	4000	90
26	700mA	2760	2291	2700	90
		2940	2440	3000	90
		3179	2639	4000	90

Driver per uso remoto da ordinare separatamente
LED drivers for remote use should be ordered separately

81-04012	Output 700mA
81-04044	Output 700mA Regolabile sul taglio di fase / Dimmable on the mains
81-02413	Output 700mA Dimmerabile DALI / DALI dimmable

Accessori ottici intercambiabili / Replaceable optical accessories



28-3959-30
Frangiluce alveolare (da utilizzare insieme a snoot cod. 28-3957-30)
Honeycomb (to be used with snoot code 28-3957-30)



28-3957-30
Cilindro antiabbagliamento
Snoot



Iconica



06

Punti sistemi da incasso

recessed systems

Lo sguardo segue percorsi di luce

The eye follows paths of light

^{ITA} I sistemi da incasso sono gli autori di coreografie sempre nuove, perché l'effetto di continuità luminosa sui soffitti è personalizzabile per creare combinazioni ogni volta inedite. Le necessità architettoniche sono ampiamente corrisposte dal design del prodotto.

Il sistema Broadway è innovativo e coerente. Inserito in un ambiente sobrio, ma elegante e ricercato, è in grado di trasformarsi da punto luce a vero e proprio complemento d'arredo.

^{EN} Recessed systems are the authors of ever-new choreographies, because the effect of luminous continuity on the ceilings can be customized to create combinations that are new every time. The architectural needs are certainly matched by the product design.

The Broadway recessed system is innovative and consistent. Integrated into a sober but elegant and refined environment, it can transform itself from a light point into a real piece of furniture.



Broadway con proiettore custom / Broadway with custom spotlight



Villa Mirella – Ruta di Camogli (Interior & Lighting Design: SLAM Architects)



Huawei Flagship Store – Berlin (Retail Architecture Studio: Lonsdale Design / Lights: IPSO)
Broadway con proiettori custom / Broadway with custom spotlights

^{ITA} La luce all'interno dei profili genera composizioni flessibili e dinamiche.

^{EN} The light inside the profiles generates flexible and dynamic compositions.

Broadway

^{ITA} Applicato in controsoffitti di cartongesso, consente l'installazione di apparecchi a scomparsa. È costituito da due misure di profili in alluminio estruso in finitura nera, con o senza binario elettrificato trifase oppure monofase dimmerabile DALI.

Tramite un innovativo sistema di ancoraggio a slitta, sul binario si posizionano proiettori cilindrici, con sorgenti luminose LED COB e lenti siliconiche.

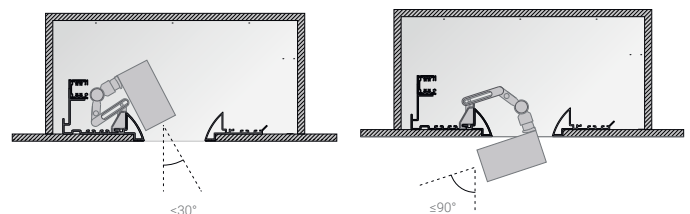

^{EN} Installed in plasterboard false ceilings, Broadway allows the installation of retractable light fittings. It consists of two extruded aluminium profiles in black finish, with a three-phase or DALI dimmable single-phase electrified track as an option.

The cylindrical spotlights are equipped with the last generation of LEDs and silicone lenses. They can be anchored to the track through an innovative slide fixing system.

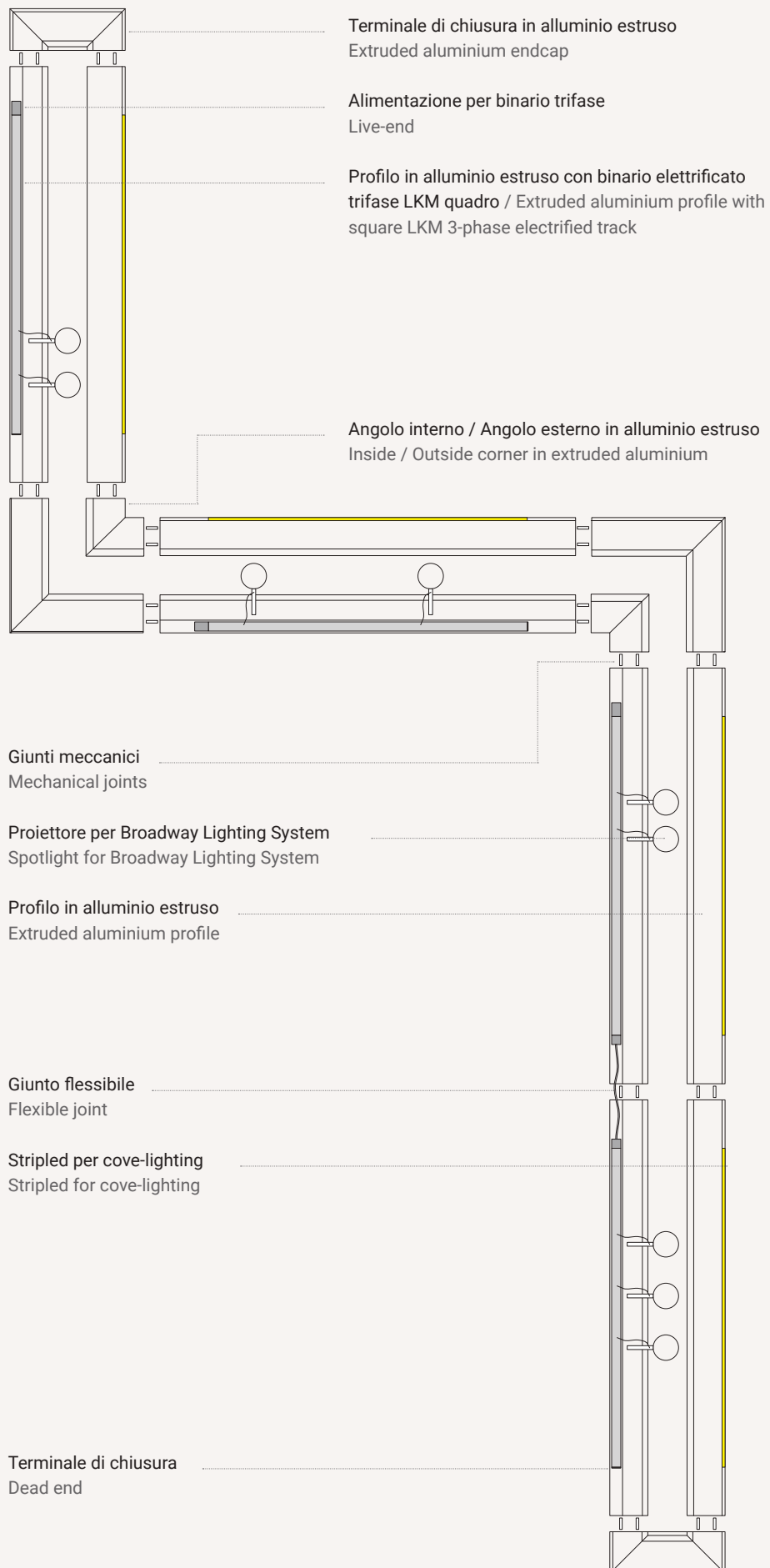

05

Punti



sistemi da incasso

recessed system



Huawei Flagship Store – Berlin
(Retail Architecture Studio: Lonsdale Design
Lights: IPSO)

Broadway con proiettori custom
Broadway with custom spotlights

	Products	Pages
	Broadway	300
	Microperfetto Large Broadway Zoom	302

BROADWAY



Codice base Base code	Lunghezza Length (mm)	Finitura Finish
Profilo in alluminio estruso / Extruded aluminium profile		
7842-	13 1300mm	-16
	23 2300mm	

16 Nero
Black

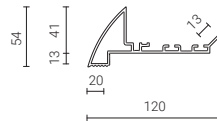
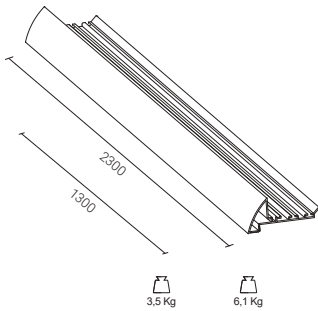

Codice base Base code	Lunghezza Length (mm)	Finitura Finish
Profilo in alluminio estruso con binario elettrificato trifase LKM quadro / Extruded aluminium profile with square LKM three-phase electrified track		
7841-	13 1300mm	-16
	23 2300mm	

Codice base Base code	Lunghezza Length (mm)	DALI	Finitura Finish
Profilo in alluminio estruso con binario elettrificato monofase DKM dimmerabile DALI / Extruded aluminium profile with DALI dimmable DKM single-phase electrified track			
7841-	13 1300mm	D	-16
	23 2300mm		

16 Nero
Black

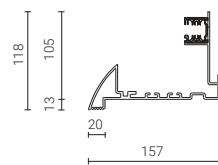
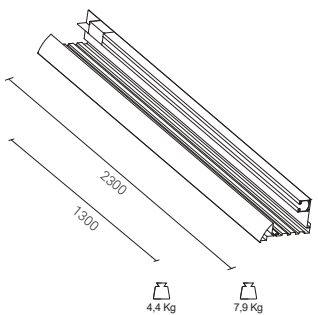

Accessori per binario trifase LKM quadro / monofase DKM dimmerabile DALI
Accessories for LKM three-phase / DALI dimmable DKM single-phase square track

7658-10-W
Giunto flessibile (LKM / DKM)
Flexible joint



30

7659-00-W
Terminale di chiusura (LKM / DKM)
Dead end



30

7652-10-W
Alimentazione destra (LKM)
Right live-end



30

7652-11-W
Alimentazione sinistra (LKM)
Left live-end



30

7651-10-W
Alimentazione destra (DKM)
Right live-end



30

7651-11-W
Alimentazione sinistra (DKM)
Left live-end



30



Codice base	Finitura
Base code	Finish

Terminale di chiusura in alluminio estruso
Extruded aluminium endcap

7850-00 -16

16 Nero
Black

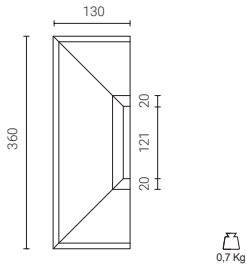

Codice base	Applicazione	Finitura
Base code	Application	Finish

Angolo interno / esterno in alluminio estruso
Inside / outside corner in extruded aluminium

7850-	0I-00 interno / inside	-16
	0E-00 esterno / outside	

16 Nero
Black

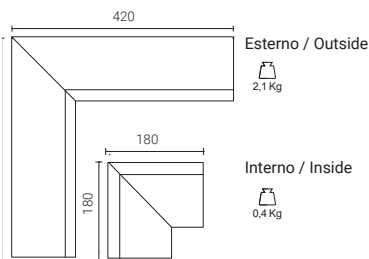

Accessorio / Accessory

12	7851-00-00
80	Giunto meccanico (kit da 4 pezzi)
	Mechanical joint (4 pieces kit)

MICROPERFETTO LARGE BROADWAY

CON LENTE / WITH LENS

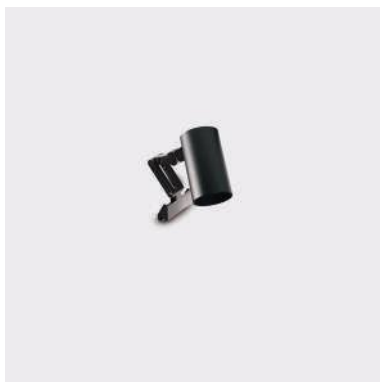

16 Nero
Black

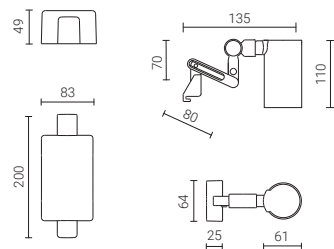

Codice base Base code	Colour T (K)	Fascio Beam	Finitura Finish
--------------------------	-----------------	----------------	--------------------

Max 4 apparecchi per ogni profilo da 1300 mm. Max 8 apparecchi per ogni profilo da 2300 mm / Max 4 fittings for each 1300 mm profile. Max 8 fittings for each 2300 mm profile

788-369 25W	C 2700K	Y 21°	-16
	B 3000K	X 30°	
	A 4000K		

Codice base Base code	Colour T (K)	Fascio Beam	DALI	Finitura Finish
--------------------------	-----------------	----------------	------	--------------------

Per profilo Broadway con binario elettrificato monofase DKM dimmerabile DALI / For Broadway profile with DALI dimmable DKM single-phase electrified track

788-369 25W	C 2700K	Y 21°	DD	-16
	B 3000K	X 30°		
	A 4000K			

Codice base Base code	Colour T (K)	Finitura Finish
--------------------------	-----------------	--------------------

Lente zoom regolabile in 7 posizioni. Max 4 apparecchi per ogni profilo da 1300 mm. Max 8 apparecchi per ogni profilo da 2300 mm / Zoom lens adjustable in 7 positions. Max 4 fittings for each 1300 mm profile. Max 8 fittings for each 2300 mm profile

787-069 12,4W	C 2700K	-16
	B 3000K	
	A 4000K	

Codice base Base code	Colour T (K)	DALI	Finitura Finish
--------------------------	-----------------	------	--------------------

Lente zoom regolabile in 7 posizioni. Per profilo Broadway con binario elettrificato monofase DKM dimmerabile DALI Zoom lens adjustable in 7 positions. For Broadway profile with DALI dimmable DKM single-phase electrified track

787-369 12,4W	C 2700K	DD	-16
	B 3000K		
	A 4000K		

220/240V - 50/60Hz

CE IP20

Caratteristiche illuminotecniche / Lighting specifications

Watt	LED Lumen	Product Lumen	Colour T (K)	CRI	Fascio Beam
25	2650	2253	2700	90	
	2760	2346	3000	90	
	3179	2543	4000	90	
12,4	1216	1034	2700	90	13° to 47°
	1310	1114	3000	90	13° to 47°
	1390	1182	4000	90	13° to 47°

Reference configurator

Il codice prodotto si compone mettendo in fila, da sinistra a destra, i dati contenuti nelle colonne a partire da "Codice base".

The product code is created by putting in sequence the data starting from "Base code", from left to right.

es: 788-369CYDD-16

Zoom technology
La rotazione del cilindro interno permette di modificare l'angolo del fascio da 13° a 47°.
The rotation of the internal snoot modifies the beam angle from 13° to 47°.

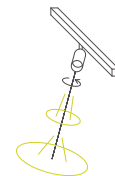



Villa Mirella – Ruta di Camogli (Interior & Lighting Design: SLAM Architects)



□ 07

Punti incassi per esterni

exterior recessed lights

Morbidi bagliori modellano il buio

A reliable guide toward the stage

^{ITA} Semplici e definite geometrie danno forma a soffuse ed eleganti atmosfere notturne. Il rigore del design della gamma di luci da incasso per esterni si armonizza con la morbidezza della luce emanata, valorizzando percorsi e architetture nel buio. Gli incassi da terra per esterni segnano il percorso della luce, orientando il cammino. Caratterizzati da un'estetica minimal garantiscono un'ottima qualità della luce ovunque siano collocati. Illuminano gli spazi verdi e zone di passaggio, valorizzando le architetture del contesto.

^{EN} Simple and defined geometries give shape to soft and elegant night-time atmospheres. The rigorous design of this range of exterior recessed wall lights harmonizes with the softness of the light, enhancing paths and architecture in the dark. The exterior inground lights mark a path of light, directing the way or lighting up walls and columns. Featuring a minimal design, and a very small recess depth, they offer excellent quality of light wherever they are placed.





Nauto è perfettamente integrabile nella pavimentazione come luce segnapasso e decorativa. La versione con lente in PMMA rende il prodotto ancora più versatile.

Nauto can be perfectly fitted in the floor and it is ideal as step light and marker in many applications. The version with a PMMA lens makes the product even more versatile.



^{ITA} Forme discrete nascondono le viti illuminando un disegno pulito ed elegante, declinabile in molteplici finiture che permettono un alto grado di personalizzazione del progetto.

Grazie alla controcassa di dimensioni contenute, Wall Cut può essere installato in muri di spessore ridotto anche in interni.

I paletti Pole-Cut 80 con finitura ruggine creano la giusta atmosfera abbinati agli incassi Wall-Cut 80 con cornice bianca e piastra decorativa oro, per un'armonia di stile e funzionalità.

^{EN} Discrete shapes hide the screws, illuminating a clean and elegant design, available in multiple finishes that allow a high level of customization of the project.

Wall-Cut can be installed in walls with shallow thickness, for interior use, thanks to the reduced size of the recessed housing.

The Pole-Cut 80 bollards with a rust finish create the right atmosphere combined with the Wall-Cut 80 recessed fittings with white frame and gold decorative plate, for a harmony of style and functionality.



^{ITA} Wall-Cut 80: un taglio nello spessore della parete dà origine a incassi quadrati. Una geometria leggera ed armoniosa che enfatizza dettagli nell'oscurità.

^{EN} Wall-Cut 80: a cut in the thickness of the wall gives rise to square recessed lights. A light and harmonious geometry that emphasizes details in the dark.



^{ITA} La cornice, la piastra decorativa e il corpo interno si possono comporre per ottenere diverse combinazioni. La sottigliezza dell'apparecchio è ulteriormente enfatizzata dalla cornice che, nascondendo la fonte luminosa, crea un gioco di spessore di grande effetto visivo.

^{EN} You can mix the frame, the decorative plate, and the inner body to get different combinations. The frame creates a thick play of stunning visual effect, hiding the light source and emphasizing the thinness of the luminaire.





Villa Mirella – Ruta di Camogli (Interior & Lighting Design: SLAM Architects)



Minimo ingombro, massima resa, anche IP

Small footprint, maximum output. IP rated, too

^{ITA} Parte della gamma degli incassi è sviluppata con alti gradi IP per far sì che i prodotti, oltre a risultare affidabili e resistenti, possano essere integrati anche in spazi con elevati livelli di umidità (bagni, docce, spa) ed aumentando quindi le possibilità di applicazione.

^{ITA} Hanno una ridotta profondità di incasso e una moderna cornice in acciaio inox. Adatti per essere utilizzati in ambienti esterni e interni, possono essere incassati a pavimento, parete o soffitto, per effetti luminosi scenografici.

^{EN} Part of the downlights range is developed with high IP protection ratings. The fittings are reliable and resistant and can be installed into spaces with high levels of humidity (bathrooms, showers, spas). For many more possibilities of application.

^{EN} The uplights have a shallow recessed depth and a stainless steel frame with the highest IP rating of IP68 1m. Suitable for both exterior and interior use; recessed in the floor, wall or ceiling.

















07

Punti

incassi per esterni

exterior recessed lights



Products	Pages
 Perfetto-IN 50 IP65	312
 Perfetto-IN 60 IP65/20	313
 Perfetto-IN 90 IP66	313
 Perfetto-IN 90 IP66/20	314
 RA 8 L IP65 / RA 8 IP65	316
 RA 8 IP66 oscillante / tiltable	317
 Nanoperfetto IN-ground	318
 Nanoperfetto IN-ground antiglare	319
 Perfetto IN-ground	320
 Perfetto IN-ground antiglare	321
 Nauto con lente	322
 Wall-cut 80	323
 Wall-cut 150	324
 Acquarius	326
 Daisy R	328
 Daisy S	329

PERFETTO - IN 50

IP65



21 Bianco mat / Mat white
16 Nero / Black

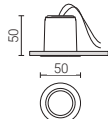

h 50 mm
Ø 43 mm
0,1 Kg

Reference configurator

Il codice prodotto si compone mettendo in fila, da sinistra a destra, i dati contenuti nelle colonne a partire da "Codice base".

The product code is created by putting in sequence the data starting from "Base code", from left to right.

es: 225-129CVN-16

Codice base Base code	Colour T (K)	Fascio Beam	No driver	Finitura Finish
Fisso con schermo in termoplastico satinato / Fixed with frosted thermoplastic screen				
225-129	C 2700K	Y 26°	N	-16
	B 3000K	V 54°		-21
	A 4000K			

CE IP65/20 IK08

Caratteristiche illuminotecniche / Lighting specifications

Watt	mA	LED Lumen	Product Lumen	Colour T (K)	CRI
4,5	500	470	329	2700	90
		490	343	3000	90
		504	353	4000	90
6,5	700	620	434	2700	90
		650	455	3000	90
		675	473	4000	90

Driver da ordinare separatamente / Driver should be ordered separately

81-04029	Output 500mA Regolabile sul taglio di fase / Dimmable on the mains
81-04026	Output 500mA Dimmerabile DALI / DALI dimmable
81-04087	Output 500mA Wireless Bluetooth
81-04027	Output 700mA Regolabile sul taglio di fase / Dimmable on the mains
81-04028	Output 700mA* - max 4 apparecchi / max 4 fittings Dimmerabile DALI / DALI dimmable <small>* Considerare una profondità di incasso a soffitto di 200 mm / Please consider a ceiling recessed depth of 200 mm</small>
81-04088	Output 700mA Wireless Bluetooth

PERFETTO - IN 60 IP65/20

CON LENTE / WITH LENS



21 Bianco mat / Mat white
16 Nero / Black

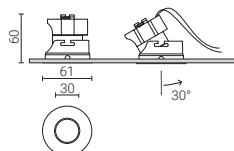

h 60 mm
Ø 57 mm
0,2 Kg

Codice base Base code	Colour T (K)	Fascio Beam	No driver	Finitura Finish
Oscillante con lente in PMMA / Tilttable with PMMA lens				
261-069	C 2700K	Y 21°	N	-16
	B 3000K	W 38°		-21
	A 4000K	R 15°+41°		

CE IP65/20

Caratteristiche illuminotecniche / Lighting specifications

Watt	mA	LED Lumen	Product Lumen	Colour T (K)	CRI
6	500	579	492	2700	90
		611	519	3000	90
		654	562	4000	90

Driver da ordinare separatamente / Driver should be ordered separately

81-04029	Output 500mA Regolabile sul taglio di fase / Dimmable on the mains
81-04026	Output 500mA Dimmerabile DALI / DALI dimmable
81-04087	Output 500mA Wireless Bluetooth

Accessori / Accessories



28-4499-30
Frangiluce alveolare
Honeycomb



28-4449-47
Vetro zigrinato
Prismatic spread lens

PERFETTO - IN 90 IP66

CON LENTE / WITH LENS

Incassi per esterni Exterior recessed system



21 Bianco mat
Mat white

16 Nero
Black

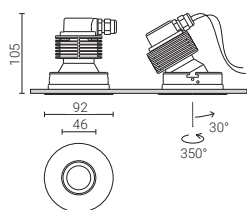

h 105 mm
Ø 92 mm
0,5 Kg



Codice base Base code	Colour T (K)	Fascio Beam	No driver	Finitura Finish
Oscillante e rotante con lente in PMMA e schermo in termoplastico satinato Rotatable and tiltable with PMMA lens and frosted thermoplastic screen				
266-069	C 2700K	Y 21°	N	-16
	B 3000K	W 38°		-21
	A 4000K			

CE IP66 IK08

Caratteristiche illuminotecniche / Lighting specifications

Watt	mA	LED Lumen	Product Lumen	Colour T (K)	CRI
6	500	579	498	2700	90
		611	525	3000	90
		654	562	4000	90
8,7	700	766	659	2700	90
		809	696	3000	90
		866	745	4000	90

Driver da ordinare separatamente / Driver should be ordered separately

81-04040	Output 500mA (IP68)
81-04029	Output 500mA Regolabile sul taglio di fase / Dimmable on the mains
81-04026	Output 500mA Dimmerabile DALI / DALI dimmable
81-04032	Output 700mA (IP68)
81-04034	Output 700mA (IP68) Dimmerabile DALI / DALI dimmable
81-04027	Output 700mA Regolabile sul taglio di fase / Dimmable on the mains
81-04028	Output 700mA Dimmerabile DALI / DALI dimmable
81-04088	Output 700mA Wireless Bluetooth

Reference configurator

Il codice prodotto si compone mettendo in fila, da sinistra a destra, i dati contenuti nelle colonne a partire da "Codice base".

The product code is created by putting in sequence the data starting from "Base code", from left to right.

es: 266-069BYN-21

Accessori ottici intercambiabili / Replaceable optical accessories



28-4163-30
Frangiluce alveolare
Honeycomb

Accessori su richiesta / Accessories on demand



84108
Connettore stagno
Rated cable connector

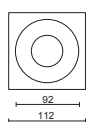

28-4318-21
Cornice quadra bianco mat
Mat white square frame

Ø 100 mm

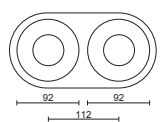

28-4181-21
Cornice tonda doppia bianco mat
Mat white twin round frame

2 x Ø 100 mm

PERFETTO - IN 90

IP66 / 20



16 Bianco / Deflettore nero
 White / Black baffle

16 Nero
 Black

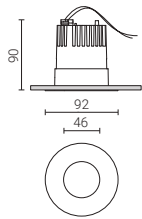

h 90 mm
 Ø 70 mm
 0,5 Kg

Reference configurator

Il codice prodotto si compone mettendo in fila, da sinistra a destra, i dati contenuti nelle colonne a partire da "Codice base".

The product code is created by putting in sequence the data starting from "Base code", from left to right.

es: 265-250CNV-73

Codice base Base code	Colour T (K)	No driver	Fascio Beam	Finitura Finish
--------------------------	-----------------	-----------	----------------	--------------------

Fisso / Fixed

265-250	C 2700K	N	Y 26°	-16
	B 3000K		W 38°	-73
	A 4000K		V 44°	

IP66/20 IK08

Caratteristiche illuminotecniche / Lighting specifications

Watt	mA	LED Lumen	Product Lumen	Colour T (K)	CRI
6	180	788	441	2700	90
		839	470	3000	90
		907	508	4000	90
9	250	1078	604	2700	90
		1148	643	3000	90
		1241	695	4000	90
12	350	1478	828	2700	90
		1574	881	3000	90
		1702	953	4000	90

Driver da ordinare separatamente / Driver should be ordered separately

81-04023	Output 180mA Regolabile sul taglio di fase e 1-10V Dimmable on the mains and 1-10V
81-04009	Output 250mA
81-04010	Output 350mA Regolabile sul taglio di fase / Dimmable on the mains
81-04003	Output 350mA Dimmerabile DALI / DALI dimmable
81-04090	Output 350mA Wireless Bluetooth

Accessori ottici intercambiabili / Replaceable optical accessories



28-4163-30
 Frangiluce alveolare
 Honeycomb



28-4190-47
 Vetro zigrinato
 Prismatic spread lens



28-4073-61
 Vetro sabbiato
 Frosted glass



28-4073-103
 Vetro ellittico
 Elliptical spread lens

Accessori su richiesta / Accessories on demand



84108
 Connettore stagno
 Rated cable connector



Silversea – Silver Dawn

RA 8 L DIXIT LED IP65



73 Bianco / Deflettore nero
White / Black baffle

16 Nero
Black

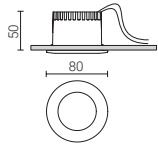

h 50 mm Ø 70 mm 0,4 Kg

Reference configurator

Il codice prodotto si compone mettendo in fila, da sinistra a destra, i dati contenuti nelle colonne a partire da "Codice base".

The product code is created by putting in sequence the data starting from "Base code", from left to right.

es: 237-239ANT-16

Codice base Base code	Colour T (K)	No driver	Fascio Beam	Finitura Finish
237-239	C 2700K	N	Y 26°	-16
	B 3000K		V 45°	-73
	A 4000K		T 65°	

CE

Caratteristiche illuminotecniche / Lighting specifications

Watt	mA	LED Lumen	Product Lumen	Colour T (K)	CRI
5,5	350	520	473	2700	90
		550	501	3000	90
		601	547	4000	90
8,5	500	670	610	2700	90
		700	638	3000	90
		751	683	4000	90

Driver da ordinare separatamente / Driver should be ordered separately

- 81-04007** Output 350mA
Regolabile sul taglio di fase e 1-10V
Dimmable on the mains and 1-10V
- 81-04003** Output 350mA
Dimmerabile DALI / DALI dimmable
- 81-04008** Output 500mA
Regolabile sul taglio di fase e 1-10V / Dimmable on the mains and 1-10V
- 81-04002** Output 500mA
Dimmerabile DALI / DALI dimmable
- 81-04087** Output 500mA
Wireless Bluetooth

RA 8 DIXIT LED IP65



73 Bianco / Deflettore nero
White / Black baffle

16 Nero
Black

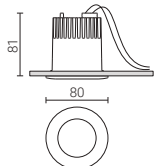

h 81 mm Ø 70 mm 0,4 Kg

Codice base Base code	Colour T (K)	No driver	Fascio Beam	Finitura Finish
237-250	C 2700K	N	Y 26°	-16
	B 3000K		V 45°	-73
	A 4000K		T 65°	

CE

Caratteristiche illuminotecniche / Lighting specifications

Watt	mA	LED Lumen	Product Lumen	Colour T (K)	CRI
9	250	1258	1107	2700	80
		1328	1169	3000	80
		1344	1183	4000	80
12	350	1726	1519	2700	80
		1821	1602	3000	80
		1843	1622	4000	80

Driver da ordinare separatamente / Driver should be ordered separately

- 81-04009** Output 250mA
- 81-04042** Output 250mA
Dimmerabile DALI / DALI dimmable
- 81-04010** Output 350mA
Regolabile sul taglio di fase / Dimmable on the mains
- 81-04003** Output 350mA
Dimmerabile DALI / DALI dimmable
- 81-04090** Output 350mA
Wireless Bluetooth

RA 8 DIXIT LED IP66

OSCILLANTE / TILTABLE

Incassi per esterni Exterior recessed system



21 **Bianco mat** / Mat white
 16 **Nero** / Black

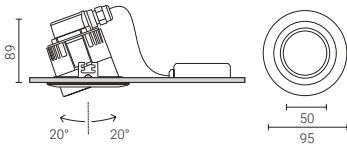

h 89 mm Ø 95 mm 0,7 Kg

Codice base Base code	Colour T (K)	Fascio Beam	Finitura Finish
--------------------------	-----------------	----------------	--------------------

LED driver incluso / LED driver included

235-250	C 2700K	Y 26°	-16
	B 3000K	V 45°	-21
	A 4000K	T 65°	

220/240V - 50/60Hz



Caratteristiche illuminotecniche / Lighting specifications

Watt	LED Lumen	Product Lumen	Colour T (K)	CRI
12	1726	1519	2700	80
	1821	1602	3000	80
	1843	1622	4000	80

NANOPERFETTO IN - GROUND CON LENTE / WITH LENS

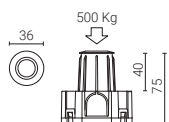
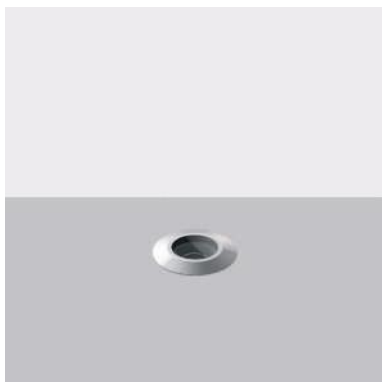

Reference configurator

Il codice prodotto si compone mettendo in fila, da sinistra a destra, i dati contenuti nelle colonne a partire da "Codice base".

The product code is created by putting in sequence the data starting from "Base code", from left to right.

es: 1528BX010

Codice base Base code	Colour T (K)	Fascio Beam	Chiusura Closing
--------------------------	-----------------	----------------	---------------------

Con molle e controcassa per installazione a terra come **calpestabile**.
Con lente non sostituibile / With springs and recessed housing for in-ground installation as a walk-over fitting. With not replaceable lens

1528	C 2700K	Z 14°	000
	B 3000K	X 30°	
		V 45°	



Caratteristiche illuminotecniche / Lighting specifications

Watt	mA	LED Lumen	Product Lumen	Colour T (K)	CRI
3	700	350	315	2700	90
		350	315	3000	90

Driver da ordinare separatamente / Driver should be ordered separately

81-02531 Output 700mA - max 3 apparecchi / max 3 fittings
Corrente costante / Constant current

NANOPERFETTO IN - GROUND CON LENTE / WITH LENS

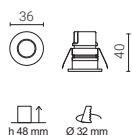
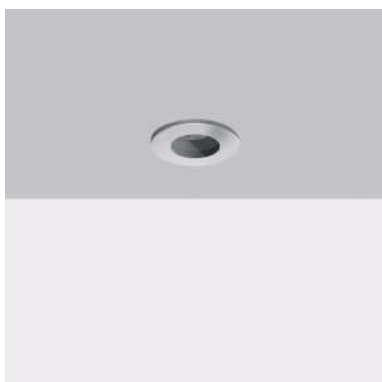

Codice base Base code	Colour T (K)	Fascio Beam	Chiusura Closing
--------------------------	-----------------	----------------	---------------------

Con molle per installazione in **pannellature** e controsoffitti. Con lente non sostituibile. / With springs for panelling and false ceiling mounting. With not replaceable lens.

1528	C 2700K	Z 14°	010
	B 3000K	X 30°	
		V 45°	



Caratteristiche illuminotecniche / Lighting specifications

Watt	mA	LED Lumen	Product Lumen	Colour T (K)	CRI
3	700	350	315	2700	90
		350	315	3000	90

Driver da ordinare separatamente / Driver should be ordered separately

81-02531 Output 700mA - max 3 apparecchi / max 3 fittings
Corrente costante / Constant current

Accessori su richiesta / Accessories on demand

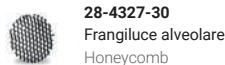
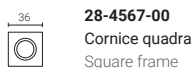
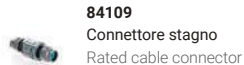

NANOPERFETTO IN - GROUND

ANTIGLARE

Incassi per esterni Exterior recessed system

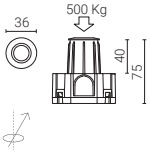

Codice base Base code	Colour T (K)	Chiusura Closing
--------------------------	-----------------	---------------------

Con molle e controcassa per installazione a terra come calpestabile.
Fascio asimmetrico / With springs and recessed housing for in-ground installation as a walk-over fitting. **Asymmetric beam**

1528	C 2700K	100
	B 3000K	

CE IP68 IK10
1mt

Caratteristiche illuminotecniche / Lighting specifications

Watt	mA	LED Lumen	Product Lumen	Colour T (K)	CRI
3	700	350	315	2700	90
		350	315	3000	90

Driver da ordinare separatamente / Driver should be ordered separately

81-02531 Output 700mA - max 3 apparecchi / max 3 fittings
 Corrente costante / Constant current

Reference configurator

Il codice prodotto si compone mettendo in fila, da sinistra a destra, i dati contenuti nelle colonne a partire da "Codice base".

The product code is created by putting in sequence the data starting from "Base code", from left to right.

es: **1528C100**

Accessori su richiesta / Accessories on demand

84109
 Connettore stagno
 Rated cable connector

28-4567-00
 Cornice quadra
 Square frame

PERFETTO IN - GROUND CON LENTE / WITH LENS

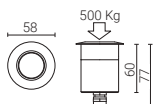
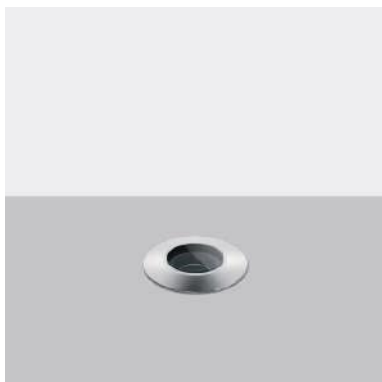

0.7 Kg

Codice base Base code	Colour T (K)	Fascio Beam	Chiusura Closing
--------------------------	-----------------	----------------	---------------------

Con lente non sostituibile / With not replaceable lens

1456	C 2700K B 3000K	Y 21°	000
-------------	----------------------------------	--------------	------------

CE IP68 1mt IK10

Caratteristiche illuminotecniche / Lighting specifications

Watt	mA	LED Lumen	Product Lumen	Colour T (K)	CRI
4	350	511	460	2700	85
		534	480	3000	85
4,7	400	575	518	2700	85
		602	541	3000	85

Driver da ordinare separatamente / Driver should be ordered separately

81-04020 Output 350mA - max 3 apparecchi / max 3 fittings

81-04056 Output 400mA - max 3 apparecchi / max 3 fittings

PERFETTO IN - GROUND

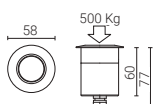

0.7 Kg

Codice base Base code	Colour T (K)	Fascio Beam	Chiusura Closing
--------------------------	-----------------	----------------	---------------------

1455	C 2700K B 3000K	W 34° V 52°	000
-------------	----------------------------------	------------------------------	------------

CE IP68 1mt IK10

Caratteristiche illuminotecniche / Lighting specifications

Watt	mA	LED Lumen	Product Lumen	Colour T (K)	CRI
6,5	700	761	685	2700	80
		785	550	3000	80

Driver da ordinare separatamente / Driver should be ordered separately

81-04065 Output 700mA (IP67) - max 2 apparecchi / max 2 fittings

Accessori ottici intercambiabili solo per Perfetto IN - Ground con lente / Replaceable optical accessories only for Perfetto IN - Ground with lens



28-4499-30
Frangiluce alveolare
Honeycomb



28-4499-47
Vetro zigrinato
Prismatic spread lens

Accessori ottici intercambiabili solo per Perfetto IN - Ground / Replaceable optical accessories only for Perfetto IN - Ground



28-4200-30
Frangiluce alveolare
Honeycomb



28-4177-4730
Vetro trasparente semi serigrafato
nero, effetto antiabbagliante
Black silk-screened clear glass,
with anti-dazzling effect



28-4177-47
Vetro zigrinato
Prismatic spread lens

Accessori su richiesta / Accessories on demand



28-4195-30
Controcassa per installazione
come calpestabile / Recessed
housing for installation in-ground



28-4197-48
Molle per montaggio in
controsoffitti e pannellature
Springs for false ceilings and
panelling mounting



160821
Bobina di cavo di alimentazione
H05RN-F, 2x1mm², 10 mt
10 mt supply cable coil H05RN-F
2x1mm²



84108
Connettore stagno
Rated cable connector

PERFETTO IN - GROUND

ANTIGLARE

Incassi per esterni Exterior recessed system

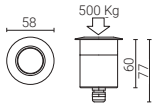

0.7 Kg



Codice base Base code	Colour T (K)	Chiusura Closing
Fascio asimmetrico / Asymmetric beam.		
1453	C 2700K	100
	B 3000K	

CE IP68 1mt IK10

Caratteristiche illuminotecniche / Lighting specifications

Watt	mA	LED Lumen	Product Lumen	Colour T (K)	CRI
3	700	350	315	2700	80
		350	315	3000	80

Driver da ordinare separatamente / Driver should be ordered separately

81-04065 Output 700mA (IP67) - max 4 apparecchi / max 4 fittings

Reference configurator

Il codice prodotto si compone mettendo in fila, da sinistra a destra, i dati contenuti nelle colonne a partire da "Codice base".

The product code is created by putting in sequence the data starting from "Base code", from left to right.

es: 1453B100

Accessori su richiesta / Accessories on demand



28-4195-30
Controcassa per installazione
come calpestabile / Recessed
housing for installation in-ground



28-4197-48
Molle per montaggio in
controsoffitti e pannellature
Springs for false ceilings and
panelling mounting



160821
Bobina di cavo di alimentazione
H05RN-F, 2x1mm², 10 mt
10 mt supply cable coil H05RN-F
2x1mm²



84108
Connettore stagno
Rated cable connector

NAUTO

CON LENTE / WITH LENS

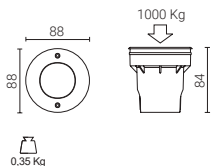

Codice base Base code	Colour T (K)	Fascio Beam	Linea Line	Chiusura Closing
--------------------------	-----------------	----------------	---------------	---------------------

Con lente in PMMA e controcassa inclusa
With PMMA lens and recessed housing included

1557	B 3000K	Z 24°	1	10
	A 4000K	W 39°	2	

CE IP67 IK10

Caratteristiche illuminotecniche / Lighting specifications

Watt	mA	LED Lumen	Product Lumen	Colour T (K)	CRI
4,7	400	600	528	3000	85
		632	556	4000	85

Driver da ordinare separatamente / Driver should be ordered separately

81-04056 Output 400mA

Reference configurator

Il codice prodotto si compone mettendo in fila, da sinistra a destra, i dati contenuti nelle colonne a partire da "Codice base".

The product code is created by putting in sequence the data starting from "Base code", from left to right.

es: 1557AZ210

Accessori / Accessories



160821
Bobina di cavo di alimentazione
H05RN-F, 2x1mm², 10 mt
10 mt supply cable coil H05RN-F
2x1mm²



84108
Connettore stagno
Rated cable connector

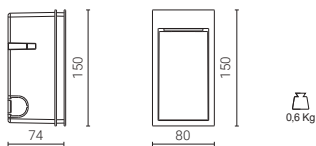
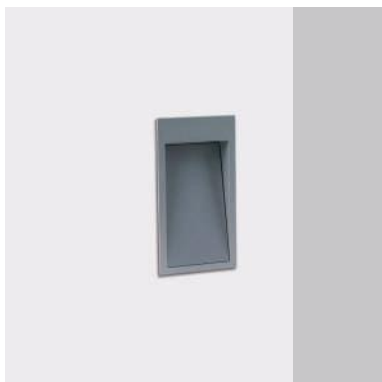

Codice base Base code	Colour T (K)	Chiusura Closing
---------------------------------	------------------------	----------------------------

Corpo interno (LED + driver + controcassa)
Inner body (LED + driver + recessed housing)

1511	C 2700K B 3000K	47
-------------	----------------------------------	-----------

220/240V - 50/60Hz



Caratteristiche illuminotecniche / Lighting specifications

Watt	LED Lumen	Product Lumen	Colour T (K)	CRI	Fascio Beam
4,5	500	225	2700	80	α 53° / β 91°
	500	225	3000	80	α 53° / β 91°

Corpo esterno da ordinare separatamente (cornice + piastra decorativa)
Outer body to be ordered separately (frame + decorative plate)

Codice Code	Cornice Frame		Piastra Plate
28-04093-01	Nero / Black	+	Nero / Black
28-04093-2131	Bianco / White	+	Bianco / White
28-04093-67	Ruggine / Rust	+	Ruggine / Rust
28-04093-85	Metal / Silver	+	Metal / Silver
28-04093-100	Nero / Black	+	Oro satinato / Satined gold

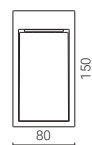

Reference configurator

Il codice prodotto si compone mettendo in fila, da sinistra a destra, i dati contenuti nelle colonne a partire da "Codice base".

The product code is created by putting in sequence the data starting from "Base code", from left to right.

es: 1511C47

Accessori su richiesta / Accessories on demand



28-4285-00
Struttura con molle per montaggio su pannellature e cartongesso
Body with springs for panelling and plasterboard mounting



67 mm



140 x 75 mm

Accessori intercambiabili / Replaceable accessories



28-04094-30
Piastra decorativa nera
Black front plate



28-04094-31
Piastra decorativa bianca
White front plate



28-04094-51
Piastra decorativa metal
Silver front plate



28-04094-67
Piastra decorativa ruggine
Rust front plate



28-04094-100
Piastra decorativa oro satinato
Satined gold front plate

WALL-CUT 150

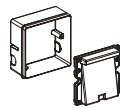
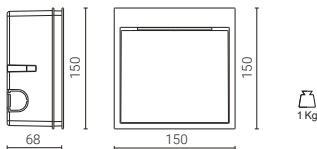

Codice base Base code	Watt	Colour T (K)	Chiusura Closing
--------------------------	------	-----------------	---------------------

Corpo interno (LED + driver + controcassa)
Inner body (LED + driver + recessed housing)

150	7 2,8W	C 2700K	47
	8 9W	B 3000K	

220/240V - 50/60Hz



Caratteristiche illuminotecniche / Lighting specifications

Watt	LED Lumen	Product Lumen	Colour T (K)	CRI	Fascio Beam
2,8	250	140	2700	90	α 53° / β 91°
	250	140	3000	90	α 53° / β 91°
9	1000	412	2700	80	α 53° / β 91°
	1000	412	3000	80	α 53° / β 91°

Corpo esterno da ordinare separatamente (cornice + piastra decorativa)
Outer body to be ordered separately (frame + decorative plate)

Codice Code	Cornice Frame		Piastra Plate
28-04082-01	Nero / Black	+	Nero / Black
28-04082-2131	Bianco / White	+	Bianco / White
28-04082-67	Ruggine / Rust	+	Ruggine / Rust
28-04082-85	Metal / Silver	+	Metal / Silver

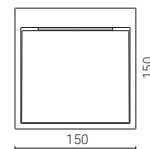

Reference configurator

Il codice prodotto si compone mettendo in fila, da sinistra a destra, i dati contenuti nelle colonne a partire da "Codice base".

The product code is created by putting in sequence the data starting from "Base code", from left to right.

es: 1508C47

Accessori intercambiabili / Replaceable accessories



28-04083-30
Piastra decorativa nera
Black front plate



28-04083-31
Piastra decorativa bianca
White front plate



28-04083-51
Piastra decorativa metal
Silver front plate



28-04083-67
Piastra decorativa ruggine
Rust front plate

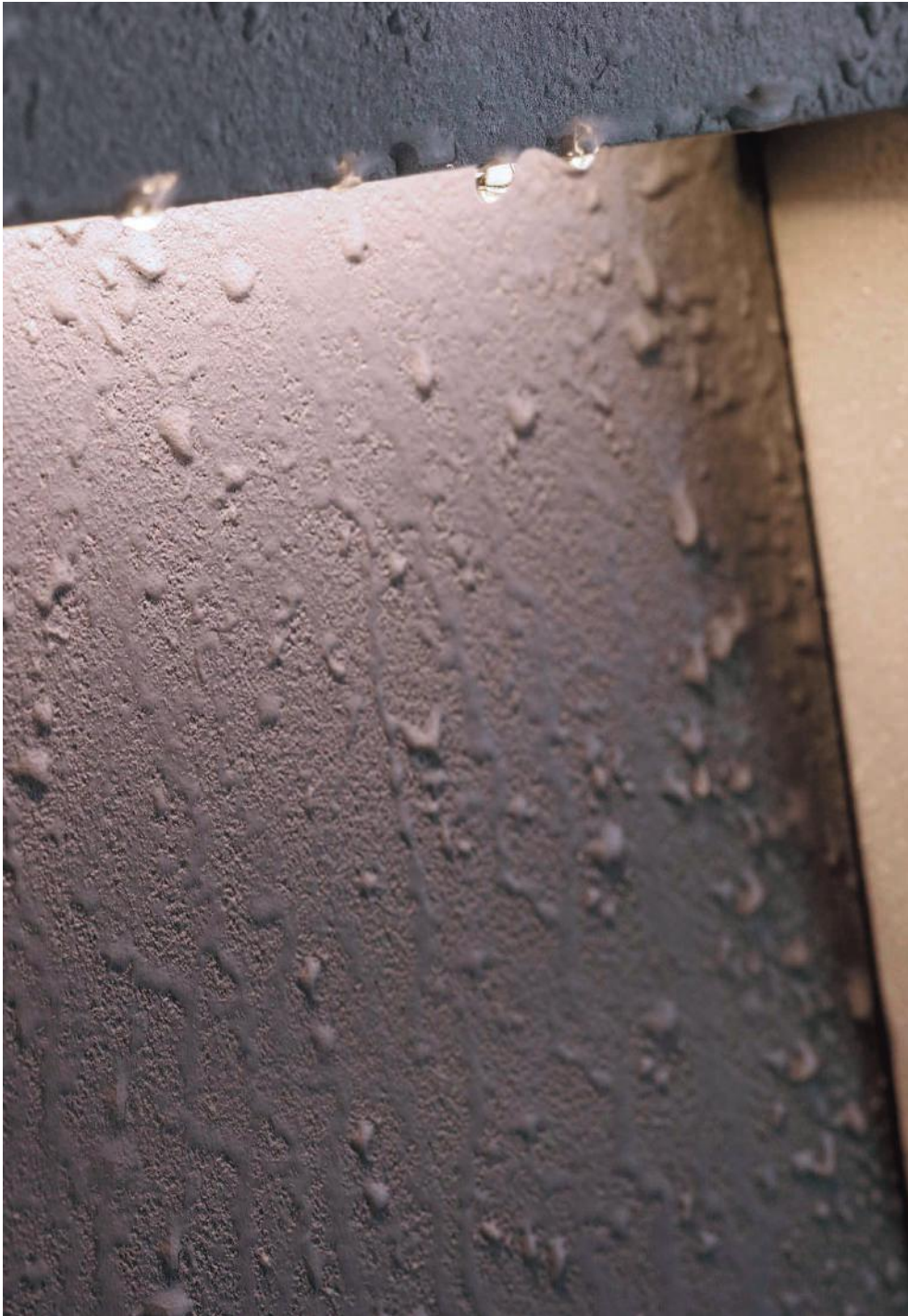

AQUARIUS

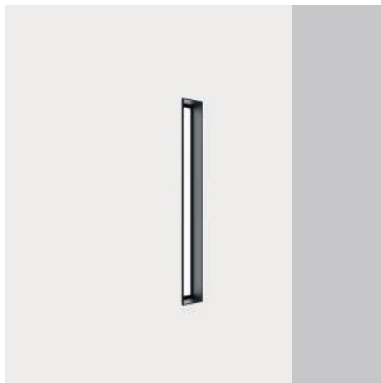

01 Bianco mat
Mat white

02 Nero
Black

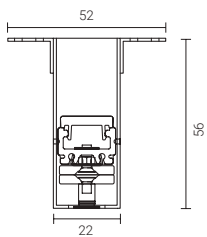

h 56 mm
270x52 mm
0,60 Kg

Modalità di applicazione Application mode

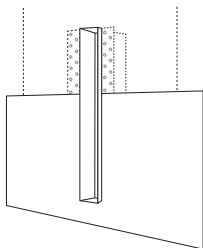

Reference configurator

Il codice prodotto si compone mettendo in fila, da sinistra a destra, i dati contenuti nelle colonne a partire da "Codice base".

The product code is created by putting in sequence the data starting from "Base code", from left to right.

es: AQ2702-OZ01L27

Codice base Base code	Ottica Optic	Colour T (K)	Finitura Finish	Chiusura Closing
--------------------------	-----------------	-----------------	--------------------	---------------------

Variante da comporre a seconda delle proprie necessità
Variant to compose according to your needs.

AQ2702 - 16W	O opale / opal	Z 2700K	01	L27 270mm
		C 3000K	02	
		N 4000K		

24Vdc



Caratteristiche illuminotecniche / Lighting specifications

Watt	Vdc	LED Lumen	Product Lumen	Colour T (K)	CRI
16	24	261	385	2700	93
		305	75	3000	93
		-	410	4000	93

Driver da ordinare separatamente / Drivers to be ordered separately

AL00078 Output 24Vdc
On/Off - DALI
Massimo numero faretti 3/ Maximum number of spotlights 3

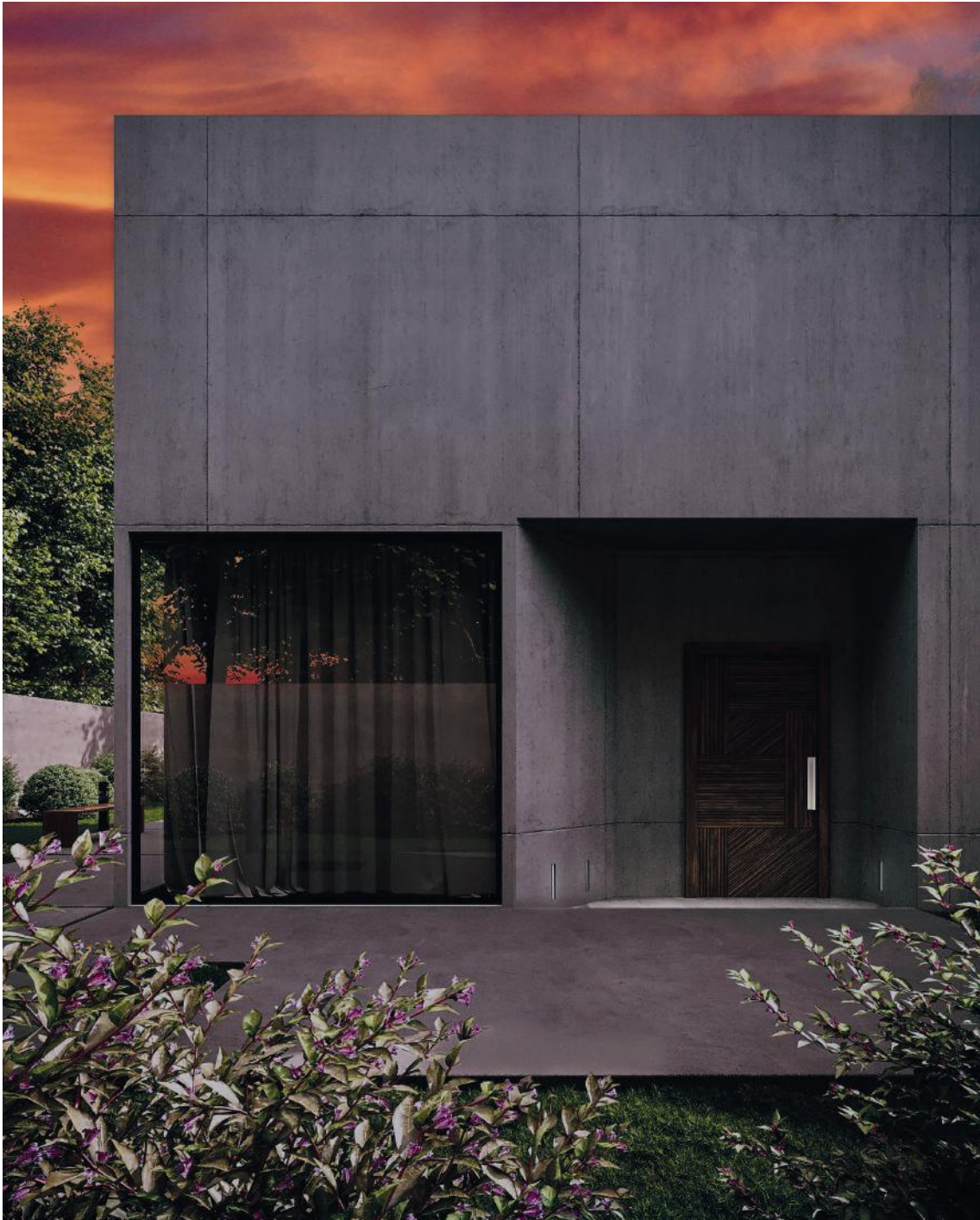

Aquarius

DAISY R



01 Bianco White 02 Nero Black 07 Oro Gold

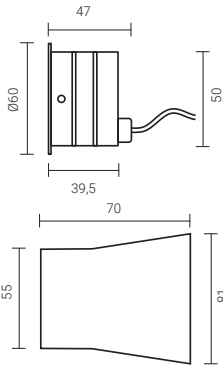

h 70 mm Ø 81 mm 0,22 Kg

Codice base Base code	Ottica Optic	Colour T (K)	Finitura Finish	Chiusura Closing
--------------------------	-----------------	-----------------	--------------------	---------------------

Variante da comporre a seconda delle proprie necessità
Variant to compose according to your needs.

D60R -		Z 2700K	01	
		C 3000K	02	
		N 4000K	07	

12Vdc



Caratteristiche illuminotecniche / Lighting specifications

Watt	Vdc	LED Lumen	Product Lumen	Colour T (K)	CRI
1	12	105	84	2700	83
		111	89	3000	83
		116	93	4000	83

Driver da ordinare separatamente / Drivers to be ordered separately

AL00079 Output 12V
On/Off - DALI
Massimo numero faretti 8 / Maximum number of spotlights 8

Reference configurator

Il codice prodotto si compone mettendo in fila, da sinistra a destra, i dati contenuti nelle colonne a partire da "Codice base".

The product code is created by putting in sequence the data starting from "Base code", from left to right.

es: D60R-C02



- 01 **Bianco**
White
- 02 **Nero**
Black
- 07 **Oro**
Gold

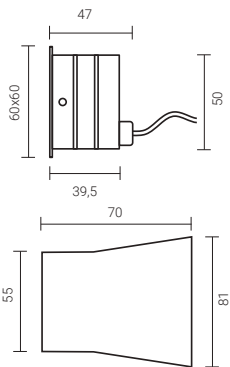

- h 70 mm
- Ø 81 mm
- 0,22 Kg

Codice base Base code	Colour T (K)	Finitura Finish	Chiusura Closing
--------------------------	-----------------	--------------------	---------------------

Variante da comporre a seconda delle proprie necessità
Variant to compose according to your needs.

D60S -	Z 2700K	01	
	C 3000K	02	
	N 4000K	07	

12 Vdc



Caratteristiche illuminotecniche / Lighting specifications

Watt	Vdc	LED Lumen	Product Lumen	Colour T (K)	CRI
1	12	105	84	2700	83
		111	89	3000	83
		116	93	4000	83

Driver da ordinare separatamente / Drivers to be ordered separately

AL00079 Output 12V
On/Off - DALI
Massimo numero faretti 8/ Maximum number of spotlights 8

Reference configurator

Il codice prodotto si compone mettendo in fila, da sinistra a destra, i dati contenuti nelle colonne a partire da "Codice base".

The product code is created by putting in sequence the data starting from "Base code", from left to right.

es: D60S-Z07



□ 08

Punti

proiettori per esterni

exterior projectors

L'accento è sull'esterno

The focus is on the exterior

^{ITA} Un'attenta ricerca in sviluppo e progettazione è a fondamento della creazione di questi proiettori. Una gamma che fa del minimalismo un elemento distintivo con la volontà di rendere i prodotti quasi impercettibili. Lo scopo è quello di limitare al massimo l'aspetto invasivo dell'apparecchio e focalizzarsi su ciò che è importante, ovvero gli elementi da valorizzare.

^{EN} Careful research in development and design is the basis of the creation of these projectors. A range that makes minimalism a peculiar detail for almost imperceptible fittings. The aim is to minimize the invasive part of the device and focus on what is salient, that is, the elements to be enhanced.



Perfetto IP66 con snoot asimmetrico.
Perfetto IP66 with asymmetric snoot



^{ITA} Danno il loro meglio negli spazi esterni dove è richiesta una luce d'accento. Accessoriabili con dispositivi ottici per ridurre l'abbagliamento e direzionare il fascio luminoso, si distinguono per la purezza della forma e la scelta dei materiali.

^{EN} These projectors are well suited for accent lighting in exterior spaces. They feature accessories for glare reduction and for shielding the light beam. The purity of their shape and the choice of the construction materials makes them original and unique.



^{ITA} I proiettori Microperfetto IP66 e Perfetto IP66 possono essere accessoriati con snoot asimmetrico per direzionare il fascio luminoso e ridurre l'abbagliamento. Numerose le applicazioni: a parete, a soffitto, a pavimento oppure nel terreno.

^{EN} Microperfetto IP66 and Perfetto IP66 projectors can be equipped with an asymmetrical snoot to shield off the light beam and to reduce glare. They are suitable for many applications: wall, ceiling, or floor mounted.



^{ITA} Grazie al design minimale, dalle dimensioni miniaturizzate, contribuiscono alla resa estetica delle scelte d'arredo outdoor, in maniera discreta ed estremamente proporzionata. La semplicità di installazione e l'alta resistenza, favorita dallo speciale trattamento antiossidante e dalle guarnizioni siliciche, li rendono prodotti decisamente efficienti e versatili.

La gamma di proiettori per esterni nasce per illuminare spazi all'aperto, ma design e performance accompagnano coerentemente il progetto anche negli spazi ibridi tra indoor e outdoor, suggerendo una continuità percettiva del confine permeabile tra l'interno e l'esterno.

^{EN} Thanks to the minimal design, with miniaturized dimensions, they contribute in a discreet and proportionate way to the aesthetics of the outdoor furniture. The easiness of installation and high resistance, thanks to the special antioxidant treatment and silicone gaskets, make them very efficient and versatile products.

The range of outdoor projectors aims to illuminate outdoor spaces. Their consistent design and performance adapt the project even in hybrid spaces between interior and outdoor, suggesting a perceptive continuity of the permeable boundary between inside and outside.



08

Punti

proiettori per esterni

exterior projectors



	Products	Pages
	Microperretto IP66	336
	Perfetto IP66	338
	Dino con lente	339

MICROPERFETTO IP66

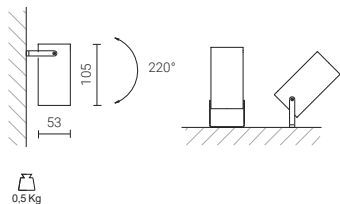

Codice base Base code	Colour T (K)	Fascio Beam	Finitura Finish
Driver integrato 230V - con lente in PMMA 230V integrated driver - with PMMA lens			
1910	C 2700K	Y 21°	0030 nero / black
	B 3000K	W 38°	0067 ruggine / rust
			0088 rame spazzolato brushed copper

Codice base Base code	Colour T (K)	Fascio Beam	Finitura Finish
Per trasformatore elettronico 48Vdc - con lente in PMMA For 48Vdc electronic transformer - with PMMA lens			
1912	C 2700K	Y 21°	0030 nero / black
	B 3000K	W 38°	0067 ruggine / rust
			0088 rame spazzolato brushed copper

CE IP66 IK10

Caratteristiche illuminotecniche / Lighting specifications

Watt	V/Vdc	LED Lumen	Product Lumen	Colour T (K)	CRI
6	230V	699	615	2700	85
		730	643	3000	85
8,7	48Vdc	925	773	2700	85
		976	808	3000	85

Trasformatori elettronici 48Vdc per uso remoto da ordinare separatamente
48Vdc electronic transformers for remote use to be ordered separately

- 81-04054** Output 48Vdc 150W 220-240V
Dimmerabile PWM / PWM dimmable
- 81-04055** Output 48Vdc 150W 220-240V
On / Off

Reference configurator

Il codice prodotto si compone mettendo in fila, da sinistra a destra, i dati contenuti nelle colonne a partire da "Codice base".

The product code is created by putting in sequence the data starting from "Base code", from left to right.

es: 1910BY0088

Accessori ottici intercambiabili / Replaceable optical accessories



28-4499-30
Frangiluce alveolare
Honeycomb



28-4445-30
Cilindro asimmetrico
Asymmetric snoot



28-2377-30
Picchetto in termoplastico nero
Black thermoplastic spike



Codice base Base code	Colour T (K)	Fascio Beam	No driver	Finitura Finish
Sistema Dim to Warm - con lente in PMMA Dim to Warm system - with PMMA lens				
1928	M 1800-2700K	Y 19° W 36°	N	0030 nero / black 0067 ruggine / rust 0088 rame spazzolato brushed copper

Codice base Base code	Colour T (K)	Fascio Beam	No driver	Finitura Finish
Per driver DALI - con lente in PMMA For DALI driver - with PMMA lens				
1927	C 2700K B 3000K	Y 21° W 38°	N	0030 nero / black 0067 ruggine / rust 0088 rame spazzolato brushed copper

CE IP66 IK10

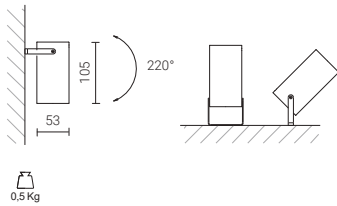

Caratteristiche illuminotecniche / Lighting specifications

Watt	mA	LED Lumen	Product Lumen	Colour T (K)	CRI
4	350	511	450	2700	85
		534	470	3000	85
6	350	564*	508	1800-2700 Dim to Warm	90
6	500	699	615	2700	85
		730	643	3000	85
8,7	700	925	773	2700	85
		967	808	3000	85

*Valore riferito alla massima dimmerazione
Value referring to max dimming

Reference configurator

Il codice prodotto si compone mettendo in fila, da sinistra a destra, i dati contenuti nelle colonne a partire da "Codice base".
The product code is created by putting in sequence the data starting from "Base code", from left to right.

es: 1927CWN0067

Driver da ordinare separatamente / Drivers should be ordered separately

- 81-04038 Output 350mA (anche per Dim to Warm / also for Dim to Warm) IP68
Dimmerabile DALI / DALI dimmable
- 81-02472 Output 350mA IP68
Regolabile sul taglio di fase / Dimmable on the mains
- 81-04039 Output 500mA IP68 - max 4 apparecchi / max 4 fittings
Dimmerabile DALI / DALI dimmable
- 81-04034 Output 700mA IP68 - max 3 apparecchi / max 3 fittings
Dimmerabile DALI / DALI dimmable
- 81-04007 Output 350mA
Regolabile sul taglio di fase e 1-10V
Dimmable on the mains and 1-10V

Accessori ottici intercambiabili / Replaceable optical accessories

28-4499-30
Frangiluce alveolare
Honeycomb

28-4445-30
Cilindro asimmetrico
Asymmetric snoot

Accessori su richiesta / Accessories on demand

28-2377-30
Picchetto in termoplastico nero
Black thermoplastic spike

PERFETTO IP66

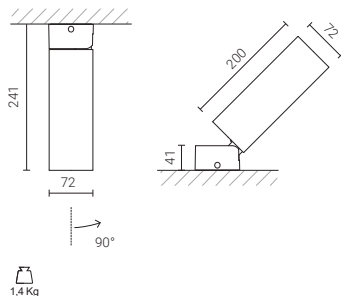

Codice base Base code	Colour T (K)	Fascio Beam	Finitura Finish	Codice base Base code	Colour T (K)	Fascio Beam	Finitura Finish
--------------------------	-----------------	----------------	--------------------	--------------------------	-----------------	----------------	--------------------

Regolabile sulla fase / Dimmable on the mains

1035 18W	B 3000K	Z 16°	0030 nero / black	1037 30W	B 3000K	X 29°	0030 nero / black
	A 4000K	Y 26°			A 4000K	W 42°	
		V 45°					

230/240V - 50/60Hz

CE IP66 IK10

Caratteristiche illuminotecniche / Lighting specifications

Watt	LED Lumen	Product Lumen	Colour T (K)	CRI
18	2400	1778	3000	85
	2450	1816	4000	85
30	3500	2594	3000	85
	3590	2660	4000	85

Reference configurator

Il codice prodotto si compone mettendo in fila, da sinistra a destra, i dati contenuti nelle colonne a partire da "Codice base".

The product code is created by putting in sequence the data starting from "Base code", from left to right.

es: 1035AV0030

Accessori ottici intercambiabili / Replaceable optical accessories



28-4163-30 (18W)
Frangiluce alveolare
Honeycomb



28-04191-47 (18W)
Vetro zigrinato
Prismatic spread lens



28-4208-30 (30W)
Frangiluce alveolare
Honeycomb



28-04190-47 (30W)
Vetro zigrinato
Prismatic spread lens



28-4130-30
Cilindro asimmetrico
Asymmetric snoot

Accessori su richiesta / Accessories on demand



28-2377-30
Picchetto in termoplastico nero
Black thermoplastic spike



84108
Connettore stagno
Rated cable connector

DINO
CON LENTE / WITH LENS

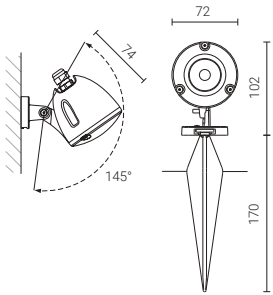

0,4 Kg

Codice base Base code	Colour T (K)	Fascio Beam	Finitura Finish
--------------------------	-----------------	----------------	--------------------

Con lente in PMMA / With PMMA lens

173	B 3000K	Z 14°	0020 grigio / grey
	A 4000K	W 36°	0030 nero / black

230/240V - 50/60Hz

CE 850° IP67/44 IK08

Caratteristiche illuminotecniche / Lighting specifications

Watt	LED Lumen	Product Lumen	Colour T (K)	CRI
4,1	534	401	3000	80
	561	421	4000	80

Reference configurator

Il codice prodotto si compone mettendo in fila, da sinistra a destra, i dati contenuti nelle colonne a partire da "Codice base".

The product code is created by putting in sequence the data starting from "Base code", from left to right.

es: **173BZ0020**



Punti

luci da facciata / plafone

façade / exterior ceiling lights

La giusta atmosfera in ogni luogo

The right atmosphere in every space

^{ITA} Apparecchi architettonici che permettono di realizzare disegni di luce sugli esterni degli edifici, esaltandone i ritmi e i particolari architettonici. Una gamma di prodotti completa caratterizzata da semplicità geometrica e tratti sinuosi che ben si adatta ad applicazioni anche in interni.

^{EN} Architectural lights allow the creation of light designs on the exterior of buildings, enhancing the rhythms and architectural details. They are a complete range of products featuring geometric simplicity and sinuous lines that are well suited also for indoor applications.



Microperfetto IP66 Applique



^{ITA} Microperpetto IP66 Applique è ideale per applicazioni in aree di passaggio e come luce da facciata. Può essere montata con luce rivolta verso l'alto o verso il basso, per effetti di luce scenografici e di grande impatto.

^{EN} Microperpetto IP66 Applique is an outdoor wall-mounted luminaire ideal for applications in public and residential areas such as passageways and façades. It can be mounted both with up-light and down-light, for scenographic light effects of great impact.



^{ITA} La gamma di luci da facciata Balti comprende quattro dimensioni che offrono svariate possibilità di illuminazione. La diffusione della luce è sottolineata da una leggera increspatura nel corpo del prodotto, che consente a Balti di collocarsi con eleganza anche in interni. Un profilo estremamente aderente alla parete, lo rende ideale per applicazioni in aree di passaggio, terrazze e come luce da facciata.

Il fascio luminoso di Balti è stato studiato con un'apertura specifica che permette di illuminare ampiamente la parete e, a seconda dell'applicazione, il soffitto o il pavimento senza abbagliare, grazie al particolare grado di inclinazione del LED all'interno dell'apparecchio.

^{EN} The fittings of the range Balti are available in four dimensions, that offer a wide spectrum of lighting options. The light diffusion is underlined by a slight rippling in the body, allowing to install Balti with elegance also in indoor applications. The fittings reduce to a minimum the protrusion from the wall: they are ideal for applications in passageways, corridors, and terraces.

Balti has been designed with a specific beam to ensure a wide lighting of the wall or of the ceiling and of the floor without glare, thanks to the specific angle of inclination of the LED within the fittings.

Balti è modello di design depositato.
Design: Enrico Davide Bona e Elisa Nobile.

Balti is a registered design model.
Design: Enrico Davide Bona e Elisa Nobile.

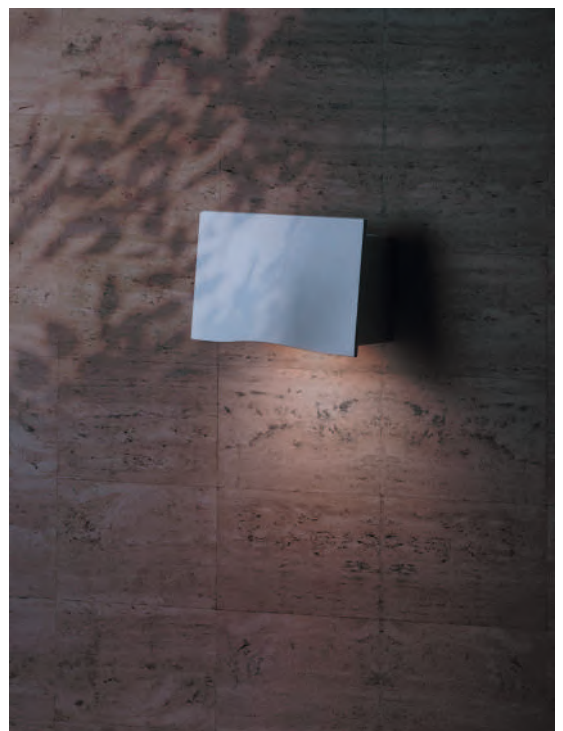



Bidi è modello di design depositato.
Design: Enrico Davide Bona e Elisa Nobile.

Bidi is a registered design model.
Design: Enrico Davide Bona e Elisa Nobile.



^{ITA} Bidi Applique è un apparecchio dal design minimale e dalla figura parallelepipedica estremamente piatta, in grado di offrire elevate prestazioni luminose, ideale per l'illuminazione di facciate, superfici verticali o porticati. E' possibile scegliere tra la versione monodirezionale con ottica simmetrica oppure la versione bidirezionale con ottica asimmetrica e luce diffusa.

^{EN} Bidi Applique is an innovative wall light with a minimal design and an extremely flat parallelepiped shape, able to stand out for the high-lighting performance. It is ideal to be mounted on façades, vertical surfaces, or arcades. It is possible to choose between the single light version with symmetric optic or the bidirectional one with asymmetric optic and diffused light.



All'aria aperta

Lighting the exterior

^{ITA} Linee geometriche essenziali, forme tonde, ma non per questo banali. Profili estremamente sottili, ma garbati ed eleganti. Prodotti che, all'interno di ambienti di vario genere si integrano senza fatica, con discrezione e sobrietà.

^{EN} Essential geometric lines, round and square shapes. Simple but not banal. They feature an extremely shallow but graceful and elegant profile. Fittings that easily integrate with discretion and sobriety into various spaces, also indoors.



^{ITA} Le plafoniere per esterni PN sono state studiate appositamente per ospitare sorgenti LED COB di ultima generazione, in grado di garantire un'elevata qualità della luce, oltre ad un considerevole risparmio energetico. Applicabile a parete o a plafone, è ideale per risolvere molteplici esigenze di illuminazione anche in ambienti interni come atri, balconi, portici, aree residenziali e spazi a verde in generale.

Il design ha privilegiato forme geometriche essenziali ed uno spessore estremamente ridotto. Lo schermo frontale, elemento estetico oltre che protettivo, è senza viti a vista. PN è modello di design depositato.
Design: Enrico Davide Bona e Elisa Nobile.

^{EN} PN outdoor ceiling lights have been specially designed to accommodate the latest generation COB LED sources that guarantee high quality of light and considerable energy savings. Applicable to the wall or ceiling, it is ideal for solving multiple lighting needs in spaces such as atriums, balconies, porches, residential areas, and green areas.

The design has privileged geometric essential lines and an extremely small thickness. The front screen, having a decorative as well as a safety function, is screwless. PN is a registered design model.
Design: Enrico Davide Bona and Elisa Nobile.











09

Punti

luci da facciata / plafone

façade / exterior ceiling lights



	Products	Pages
	Microperfetto IP66 Applique	348
	Balti 80	350
	Balti 150	350
	Balti 220	351
	Balti 260	351
	Bidi Applique	352
	Microperfetto IP66 Cupcake	354
	PN 180	356
	PN 230	356
	PN 210	357
	PN 280	357

MICROPERFETTO APPLIQUE IP66

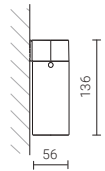

0,5 kg

Codice base Base code	Colour T (K)	Fascio Beam	Finitura Finish
--------------------------	-----------------	----------------	--------------------

Fisso con lente in PMMA / Fixed with PMMA lens

1915	B 3000K	Z 14°	00W21 bianco mat / mat white
		W 38°	00W30 nero / black
			00W67 ruggine / rust
			00W88 rame spazzolato brushed copper

220/240V - 50/60Hz

CE IP66 IK10

Caratteristiche illuminotecniche / Lighting specifications

Watt	LED Lumen	Product Lumen	Colour T (K)	CRI
6	730	642	3000	85

Reference configurator

Il codice prodotto si compone mettendo in fila, da sinistra a destra, i dati contenuti nelle colonne a partire da "Codice base".

The product code is created by putting in sequence the data starting from "Base code", from left to right.

es: 1915BW00W21



Microperetto IP66 Applique

BALTI 80



Codice base
Base code

Finitura
Finish

Monodirezionale / Single-light

1193

03
metal / silver

04
bianco / white

220/240V - 50/60Hz

CE IP65 IK09

Caratteristiche illuminotecniche / Lighting specifications

Watt	LED Lumen	Product Lumen	Colour T (K)	CRI	Fascio Beam
6,5	850	646	3000	85	110°

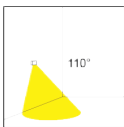
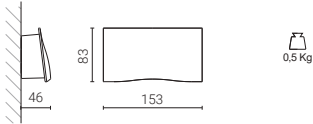

Reference configurator

Il codice prodotto si compone mettendo in fila, da sinistra a destra, i dati contenuti nelle colonne a partire da "Codice base".

The product code is created by putting in sequence the data starting from "Base code", from left to right.

es: 118504

BALTI 150



Codice base
Base code

Finitura
Finish

Monodirezionale / Single-light

1185
12W

03
metal / silver

04
bianco / white

Codice base
Base code

Finitura
Finish

Monodirezionale / Single-light

1183
26W

03
metal / silver

04
bianco / white

220/240V - 50/60Hz

CE IP66 IK08

Caratteristiche illuminotecniche / Lighting specifications

Watt	LED Lumen	Product Lumen	Colour T (K)	CRI	Fascio Beam
12	1800	1348	3000	85	110°
26	3400	2551	3000	85	110°

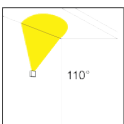
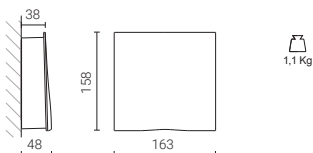

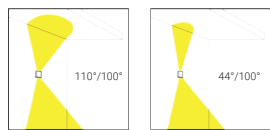
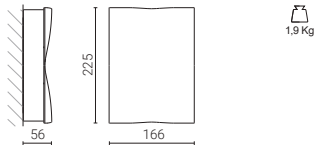

Reference configurator

Il codice prodotto si compone mettendo in fila, da sinistra a destra, i dati contenuti nelle colonne a partire da "Codice base".

The product code is created by putting in sequence the data starting from "Base code", from left to right.

es: 1081RWT03

Codice base Base code	Finitura Finish
---------------------------------	--------------------

Monodirezionale / Single-light

1196 37W	03 metal / silver
	04 bianco / white

Codice base Base code	Finitura Finish
---------------------------------	--------------------

Bidirezionale / Bi-directional

1198 2x26W	03 metal / silver
	04 bianco / white

Codice base Base code	Finitura Finish
---------------------------------	--------------------

Bidirezionale / Bi-directional

1197 18W+12,5W	03 metal / silver
	04 bianco / white

220/240V - 50/60Hz



Caratteristiche illuminotecniche / Lighting specifications

Watt	LED Lumen	Product Lumen	Colour T (K)	CRI	Fascio Beam
37	5200	4005	3000	85	100°
2x26	2x3400	2x2798	3000	85	110°/100°
18+12,5	2500+1200	2058+988	3000	85	44°/100°

BALTI 260

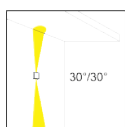
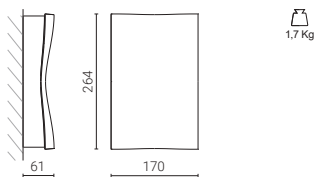

Codice base Base code	Fascio Beam	Finitura Finish
---------------------------------	-------------	--------------------

Bidirezionale / Bi-directional

1081RW	X 30°/30°	03 metal / silver
	V 50°/50°	04 bianco / white
	T 65°/65°	

220/240V - 50/60Hz



Caratteristiche illuminotecniche / Lighting specifications

Watt	LED Lumen	Product Lumen	Colour T (K)	CRI
2x18	2x2400	2x2040	3000	85

BIDI APPLIQUE



Codice base
Base code

Finitura
Finish

Testa illuminante monodirezionale con ottica simmetrica.
Regolabile sulla fase / Monodirectional lighting head with symmetric optic. Dimmable on the mains

1907
12W

01
nero / black

04
bianco / white

67
ruggine / rust

Codice base
Base code

Finitura
Finish

Testa illuminante bidirezionale con ottiche asimmetriche
Bi-directional lighting head with asymmetric optics

1906
2x12W

01
nero / black

04
bianco / white

67
ruggine / rust

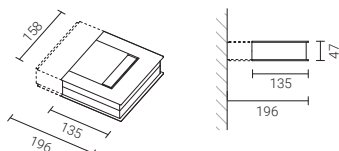

1,5kg

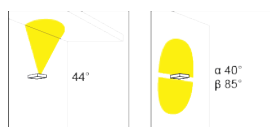

220/240V - 50/60Hz

CE IP66 IK10

Caratteristiche illuminotecniche / Lighting specifications

Watt	LED Lumen	Product Lumen	Colour T (K)	CRI	Fascio Beam
12	1800	1350	3000	85	44°
2x12	2x1800	2x1350	3000	85	α 40°/β 85°

Reference configurator

Il codice prodotto si compone mettendo in fila, da sinistra a destra, i dati contenuti nelle colonne a partire da "Codice base".

The product code is created by putting in sequence the data starting from "Base code", from left to right.

es: **190601**

Codice base
Base code

Finitura
Finish

Base per attacco a parete da ordinare separatamente
Base for wall mounting to be ordered separately

16350

01
nero / black

04
bianco / white

67
ruggine / rust

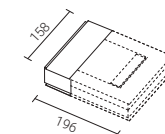
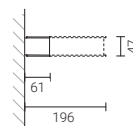

0.2 Kg



Bidi Applique

MICROPERFETTO IP66 CUPCAKE

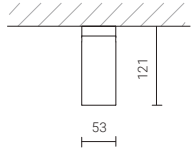

0,5 Kg

Codice base Base code	Colour T (K)	Fascio Beam	Finitura Finish
--------------------------	-----------------	----------------	--------------------

Driver integrato 230V - con lente in PMMA
230V integrated driver - with PMMA lens

⚡ 1915 6W	C 2700K	Y 21°	0021 bianco mat / mat white
	B 3000K	W 38°	0030 nero / black
			0067 ruggine / rust

Codice base Base code	Colour T (K)	Fascio Beam	Finitura Finish
--------------------------	-----------------	----------------	--------------------

Per trasformatore elettronico 48V_{dc} - con lente in PMMA
For 48V_{dc} electronic transformer - with PMMA lens

⚡ 1917 8,7W	C 2700K	Y 21°	0021 bianco mat / mat white
	B 3000K	W 38°	0030 nero / black
			0067 ruggine / rust

Codice base Base code	Colour T (K)	Fascio Beam	No driver	Finitura Finish
--------------------------	-----------------	----------------	-----------	--------------------

Per driver DALI - con lente in PMMA
For DALI driver - with PMMA lens

⚡ 1929 4W / 6W / 8,7W	C 2700K	Y 21°	N	0021 bianco mat / mat white
	B 3000K	W 38°		0030 nero / black
				0067 ruggine / rust

CE IP66 IK10

Caratteristiche illuminotecniche / Lighting specifications

Watt	V / V _{dc} / mA	LED Lumen	Product Lumen	Colour T (K)	CRI
4		511	450	2700	85
		534	470	3000	85
6	230V 500mA	699	615	2700	85
		730	643	3000	85
8,7	48V _{dc} 700mA	925	773	2700	85
		967	808	3000	85

Reference configurator

Il codice prodotto si compone mettendo in fila, da sinistra a destra, i dati contenuti nelle colonne a partire da "Codice base".

The product code is created by putting in sequence the data starting from "Base code", from left to right.

es: 1929BYN0030

Trasformatori elettronici 48V_{dc} per uso remoto da ordinare separatamente
48V_{dc} electronic transformers for remote use to be ordered separately

81-04054	Output 48V _{dc} 150W 220-240V Dimmerabile PWM / PWM dimmable
81-04055	Output 48V _{dc} 150W 220-240V On / Off

Driver da ordinare separatamente / Drivers should be ordered separately

81-04038	Output 350mA IP68 - max 5 apparecchi / max 5 fittings Dimmerabile DALI / DALI dimmable
81-04039	Output 500mA IP68 - max 4 apparecchi / max 4 fittings Dimmerabile DALI / DALI dimmable
81-04034	Output 700mA IP68 - max 3 apparecchi / max 3 fittings Dimmerabile DALI / DALI dimmable

Accessori ottici intercambiabili / Replaceable optical accessories



28-4499-30
Frangilucente alveolare
Honeycomb

Accessori su richiesta / Accessories on demand



84108
Connettore stagno
Rated cable connector



Microperfetto IP66 Cupcake

PN 180

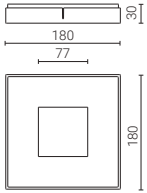

1.2Kg

Codice base
Base code

Finitura
Finish

1445

01
nero / black
03
metal / silver
04
bianco / white

220/240V - 50/60Hz

CE IP65 IK08

Caratteristiche illuminotecniche / Lighting specifications

Watt	LED Lumen	Product Lumen	Colour T (K)	CRI	Fascio Beam
12	1700	1453	3000	85	110°

Reference configurator

Il codice prodotto si compone mettendo in fila, da sinistra a destra, i dati contenuti nelle colonne a partire da "Codice base".

The product code is created by putting in sequence the data starting from "Base code", from left to right.

es: 144501

PN 230

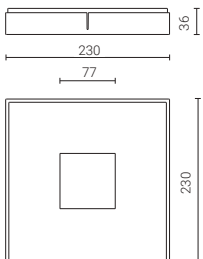

2.0 Kg

Codice base
Base code

Finitura
Finish

1440

01
nero / black
04
bianco / white

220/240V - 50/60Hz

CE IP65 IK08

Caratteristiche illuminotecniche / Lighting specifications

Watt	LED Lumen	Product Lumen	Colour T (K)	CRI	Fascio Beam
18	2400	2040	3000	85	110°

PN 210

Luci da facciata / plafone

Façade and ceiling lights

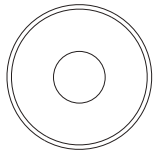
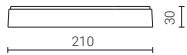

1,2 Kg

Reference configurator

Il codice prodotto si compone mettendo in fila, da sinistra a destra, i dati contenuti nelle colonne a partire da "Codice base".

The product code is created by putting in sequence the data starting from "Base code", from left to right.

es: 139203

Codice base

Base code

Finitura

Finish

1380

01
nero / black

03
metal / silver

04
bianco / white

230/240V - 50/60Hz

CE     IP65 IK08

Caratteristiche illuminotecniche / Lighting specifications

Watt	LED Lumen	Product Lumen	Colour T (K)	CRI	Fascio Beam
12	1800	1538	3000	85	120°

PN 280

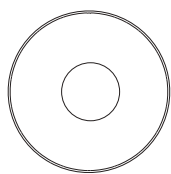
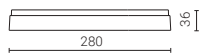

2,0 Kg

Codice base

Base code

Finitura

Finish

1390
18W

01
nero / black

03
metal / silver

04
bianco / white

Codice base

Base code

Finitura

Finish

1392
30W

01
nero / black

03
metal / silver

04
bianco / white

230/240V - 50/60Hz

CE     IP65 IK08

Caratteristiche illuminotecniche / Lighting specifications

Watt	LED Lumen	Product Lumen	Colour T (K)	CRI	Fascio Beam
18	2400	2040	3000	85	120°
30	3800	3230	3000	85	120°



□ **10**

Punti

luci d'appoggio per esterni

bollards

Protagonisti nella notte

Protagonists in the night

^{ITA} Linee sottili e geometrie compatte rendono questi prodotti diversi tra loro, ma coerenti con i contesti nei quali vengono inseriti.

La sobrietà che li caratterizza si adatta perfettamente con la resa illuminotecnica delle elevate performance che sono in grado di garantire in qualsiasi spazio esterno.

^{EN} Thin lines and compact geometries make these products different from each other but consistent with the space.

The sobriety that distinguishes them perfectly fits the high performance they can guarantee in any outdoor space.





Microperetto IP66 Stelo

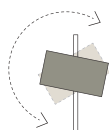

rotazione 220° | 220° tilting



In armonia con l'ambiente

In harmony with nature

^{ITA} Microperfetto IP66 Stelo è l'ultima novità della gamma di luci per esterno. Il design elegante lo rende adattabile e in perfetta armonia con qualsiasi contesto outdoor. Il prodotto è installabile in due differenti modalità: con picchetto, nel terreno, o direttamente a terra su base. Microperfetto IP66 Stelo è equipaggiato con LED COB di ultima generazione per un'elevata efficienza illuminotecnica.

^{EN} Microperfetto IP66 Stelo is the latest bollard in the range of outdoor luminaires. Its elegant and harmonious design enhances any exterior space. You can choose among different mounting options, with a spike for installation in the ground or with a steel base. Microperfetto IP66 Stelo features the latest generation of COB LEDs for high visual comfort.



Pole-cut 80



^{ITA} Pole-Cut è la nuova versione su palo di Wall-Cut, definito dalla sua rigorosa geometria e da finiture che lo rendono perfetto per applicazioni all'esterno. La luce, confortevole e morbida, valorizza percorsi e camminamenti. La coerenza di design fa sì che Pole-Cut e Wall-Cut possano essere abbinati in soluzioni progettuali prestigiose e ricercate.



^{EN} Pole-Cut is the new version on the pole of Wall-Cut recessed wall light, defined by its rigorous geometry and finishes that make it perfect for outdoor applications. The light, comfortable and soft, enhances paths and walkways. The coherence of design ensures that Pole-Cut and Wall-Cut can be combined for prestigious and refined design solutions.

QC Terme – Milano
Pole-Cut 80 ruggine / rust

10

Punti

luci d'appoggio per esterni

bollards



	Products	Pages
	Microperfitto IP66 stelo	366
	Pole-cut 80	367

MICROPERFETTO IP66 STELO

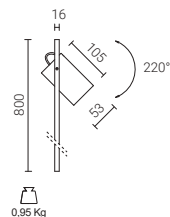

Codice base Base code	Colour T (K)	Fascio Beam	Finitura Finish
Driver integrato 230V - con lente in PMMA 230V integrated driver - with PMMA lens			
⚡ 1940 6W	C 2700K	Y 21°	0030 nero / black
	B 3000K	W 38°	0067 ruggine / rust

Codice base Base code	Colour T (K)	Fascio Beam	Finitura Finish
Per trasformatore elettronico 48Vdc - con lente in PMMA For 48Vdc electronic transformer - with PMMA lens			
⚡ 1941 8,7W	C 2700K	Y 21°	0030 nero / black
	B 3000K	W 38°	0067 ruggine / rust

CE IP66 IK10

Caratteristiche illuminotecniche / Lighting specifications

Watt	V/Vdc	LED Lumen	Product Lumen	Colour T (K)	CRI
6	230V	699	615	2700	85
		730	643	3000	85
8,7	48Vdc	925	773	2700	85
		967	808	3000	85

Trasformatori elettronici 48Vdc per uso remoto da ordinare separatamente
48Vdc electronic transformers for remote use to be ordered separately

81-04054	Output 48Vdc 150W 220-240V Dimmerabile PWM / PWM dimmable
81-04055	Output 48Vdc 150W 220-240V On / Off

Reference configurator

Il codice prodotto si compone mettendo in fila, da sinistra a destra, i dati contenuti nelle colonne a partire da "Codice base".

The product code is created by putting in sequence the data starting from "Base code", from left to right.

es: **1941CY0067**

Accessori ottici intercambiabili / Replaceable optical accessories



28-4445-30
Cilindro asimmetrico
Asymmetric snout



28-4499-30
Frangiluce alveolare
Honeycomb

Accessori obbligatori per l'installazione / Compulsory accessories for installation



28-04573-30
Picchetto in termoplastico nero
Black thermoplastic spike



28-04577-16
Base in acciaio verniciato nero
Base in black painted steel

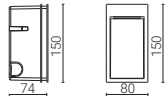

0.6 Kg

Codice base	Colour	Chiusura
Base code	T (K)	Closing

Corpo interno (LED + driver + controcassa)
Inner body (LED + driver + recessed housing)

1511	C 2700K	47
	B 3000K	

220/240V - 50/60Hz



Caratteristiche illuminotecniche / Lighting specifications

Watt	LED Lumen	Product Lumen	Colour T (K)	CRI	Fascio Beam
4,5	500	225	2700	80	α 53° / β 91°
	500	225	3000	80	α 53° / β 91°

Corpo esterno da ordinare separatamente (cornice + piastra decorativa)
Outer body to be ordered separately (frame + decorative plate)

Codice Code	Cornice Frame	Piastra Plate
-------------	---------------	---------------

28-04093-01	Nero / Black	+	Nero / Black
28-04093-67	Ruggine / Rust	+	Ruggine / Rust
28-04093-85	Metal / Silver	+	Metal / Silver
28-04093-100	Nero / Black	+	Oro satinato / Satined gold



Reference configurator

Il codice prodotto si compone mettendo in fila, da sinistra a destra, i dati contenuti nelle colonne a partire da "Codice base".

The product code is created by putting in sequence the data starting from "Base code", from left to right.

es: 1511B47

Palo rettangolare (con base e tappo)
Rectangular pole (with base and cap)

Codice Code	Finitura Finish	Altezza Height
-------------	-----------------	----------------

28-04497-01	Nero / Black	h. 300 mm
28-04497-67	Ruggine / Rust	h. 300 mm
28-04497-85	Metal / Silver	h. 300 mm
28-04370-01	Nero / Black	h. 700 mm
28-04370-67	Ruggine / Rust	h. 700 mm
28-04370-85	Metal / Silver	h. 700 mm

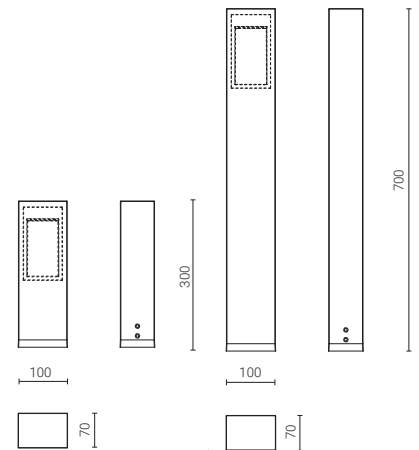

Accessori intercambiabili / Replaceable accessories



28-04094-30
Piastra decorativa nera
Black front plate



28-04094-31
Piastra decorativa bianca
White front plate



28-04094-51
Piastra decorativa metal
Silver front plate



28-04094-67
Piastra decorativa ruggine
Rust front plate



28-04094-100
Piastra decorativa oro satinato
Satin gold front plate

Come leggere il catalogo

How to read the catalogue

A PERFETTO - IN 60
CON LENTE / WITH LENS



B **260-069** C 2700K Y 21° N -16
B 3000K W 38° -21
A 4000K R 15°+41°

Codice base Base code **Colour** T (K) **Fascio** Beam **No driver** **Finitura** Finish

Codice base Base code **Colour** T (K) **No driver** **Fascio** Beam **Finitura** Finish

Oscillante con lente in PMMA / Tilttable with PMMA lens

Sistema Dim to Warm / Dim to Warm system

260-049 M 1800-2700K N Y 21° -16
W 38° -21
R 15°+41°

CE IP43

D **21** Bianco mat / Mat white **16** Nero / Black

E

C **Caratteristiche illuminotecniche / Lighting specifications**

Watt	mA	LED Lumen	Product Lumen	Colour T (K)	CRI
6	500	579	492	2700	90
		611	519	3000	90
		654	562	4000	90
5	300	494*	420	1800-2700 Dim to Warm	90

*Valore riferito alla massima dimmazione / Value referring to max dimming

F **Driver da ordinare separatamente / Driver should be ordered separately**

81-04029 Output 500mA
Regolabile sul taglio di fase / Dimmable on the mains

81-04026 Output 500mA
Dimmerabile DALI / DALI dimmable

81-04087 Output 500mA
Wireless Bluetooth

81-04075 Output 300mA
Regolabile sul taglio di fase / Dimmable on the mains

81-04074 Output 300mA
Dimmerabile DALI / DALI dimmable

81-04072 Output 300mA
Dimmerabile 1-10V / 1-10V dimmable

81-04089 Output 300mA
Wireless Bluetooth

G **Reference configurator**

Il codice prodotto si compone mettendo in fila, da sinistra a destra, i dati contenuti nelle colonne a partire da "Codice base".
The product code is created by putting in sequence the data starting from "Base code", from left to right.

es: 260-049MYN-16

H **Accessori ottici intercambiabili / Replaceable optical accessories**

28-4499-30 Frangiluce alveolare / Honeycomb

28-4449-47 Vetro zigrinato / Prismatic spread lens

A - nome del prodotto

B - codice prodotto (da comporre)

C - specifiche tecniche

I valori di flusso del LED non considerano le tolleranze costruttive dei componenti elettronici. I flussi luminosi sono rilevati a regime termico di lavoro e viene indicato il valore del fascio medio.

D - finiture disponibili

E - disegno tecnico

F - driver (dove previsto)

G - indicazioni per la composizione del codice

H - accessori (dove previsto)

A - product name

B - product code (to be composed)

C - technical specifications

The values of the LED flux do not consider the technical tolerances of the electronic components. The luminous fluxes are measured with the fittings warm from operation and we indicate the value of medium beam.

D - available finishes

E - technical drawing











F - driver (where expected)

G - indications for code composition

H - accessories (where expected)





















Marchi e simbologie

Marks and symbols

	Apparecchio conforme ai requisiti di sicurezza Europei (direttive LVD 73/23 EEC - 93/68) Product in conformity with the requirements of relevant European Safety standards
	Apparecchio garantito e certificato dall' Istituto Italiano Marchio di Qualità Guaranteed product and certified by the Italian Quality Trademark Institute
	Marchio ENEC – European Norms Electrical Certification Prodotti costruiti e certificati secondo le Norme Europee European Norms Electrical Certification – Products manufactured and certified according to European Norms
	Classe I – Apparecchio nel quale la protezione contro la scossa elettrica si basa sul contatto a terra Class I – Fitting whose protection against electric shock is based on earth wiring
	Classe II – Apparecchio nel quale la protezione contro la scossa elettrica si basa sul doppio isolamento rinforzato Class II – Fitting whose protection against electric shock is based on reinforced double insulation
	Classe III – Apparecchio nel quale la protezione contro la scossa elettrica si basa sull'alimentazione a bassissima tensione di sicurezza SELV, in cui non si producono tensioni superiori alla stessa Class III – Fitting whose protection against electric shock is based on a safety extra low voltage supply SELV, in which voltages higher than those of SELV are not generated
	Apparecchio per servizio gravoso Light fixture for heavy-duty use
	Apparecchio che supera la prova del filo incandescente a 850° The fixture stands the glow-wire test at 850°
T max	Temperatura massima superficiale dell'apparecchio Highest surface temperature of the fitting
	Prodotto non adatto per essere coperto con materiale termo isolante Luminaire not suitable for covering with thermally insulating material.
	Dim to Warm
	Controllo Wireless Wireless Control

Classificazioni di protezione internazionale

International protection rating

	Grado di protezione dell'apparecchio contro l'ingresso di solidi (identificato dalla prima cifra) e liquidi (identificato dalla seconda cifra) Protection rating classifying the degree of protection from solids (identified from the first character) and moisture (identified from the second character)			
	Protetto contro la penetrazione di corpi solidi di dimensioni superiori a Ø 12 mm. Non protetto contro la penetrazione di liquidi. Protected against the ingress of solid bodies greater than Ø 12 mm. No protection against spray water.			
	Protetto contro l'ingresso di oggetti solidi più grandi di Ø 2,5 mm. Protetto contro acqua spruzzata. Protected against the ingress of solid bodies greater than Ø 2.5 mm. Protected against sprays of water.			
	Protetto contro la penetrazione di corpi solidi di dimensioni superiori a Ø 1 mm. Non protetto contro la pioggia. Protected against the ingress of solid bodies greater than Ø 1 mm. No protection against the ingress of moisture.			
	Protetto contro la penetrazione di corpi solidi di dimensioni superiori a Ø 1 mm. Protetto contro la pioggia. Protected against the ingress of solid bodies greater than Ø 1 mm. Protection against rain.			
	Protetto contro la penetrazione di corpi solidi di dimensioni superiori a Ø 1 mm. Protetto contro gli spruzzi. Protected against the ingress of solid bodies greater than Ø 1 mm. Protection against splashing water.			
	Protetto completamente contro la penetrazione di polvere. Protetto dai getti d'acqua. Protected against the ingress of dust. Protected against jets of water.			
	Protetto completamente contro la penetrazione di polvere. Protetto dai getti d'acqua potenti. Protected against the ingress of dust. Protected from powerful jets of water.			
	Protetto completamente contro la penetrazione di polvere. Protetto dall'immersione temporanea. Protected against the ingress of dust. Protected against immersion in water for limited periods.			
	Protetto completamente contro la penetrazione di polvere. Apparecchi stagni all'immersione (con indicazione in metri di profondità consentita). Protected against the ingress of dust. Protected against total immersion in water for an indefinite period (depth shown in meters).			
	Grado di protezione dagli involucri contro gli impatti meccanici esterni (EN 50102) misurabile in Joule Housing protection degree against mechanical shocks measurable in Joule			
				
0,15 J	0,20 J	0,35 J	0,50 J	0,70 J
				
1,00 J	2,00 J	5,00 J	10,0 J	20,0 J

Condizioni generali di vendita

General sale terms and conditions

Gli ordini si intendono accettati ai prezzi e alle condizioni di vendita in vigore. A fronte di eventuali variazioni di listino e quindi di prezzi e condizioni, l'acquirente avrà la facoltà di annullare gli ordini in atto con comunicazione scritta entro 8 giorni dalla nostra informazione di variazione. Gli ordini si intendono subordinati alla nostra accettazione.

I prezzi di listino si intendono franco nostri magazzini di fabbrica, salvo accordi speciali.

Ogni nostra obbligazione cessa con la consegna della merce al vettore o allo spedizioniere. Il trasporto o la spedizione con qualsiasi mezzo si intendono sempre effettuati a rischio e pericolo dell'acquirente, con esclusione di ogni nostra responsabilità in caso di rotture, avarie, furti o manomissioni.

I termini di consegna, ove pattuiti, si intendono sempre indicativi.

L'azienda si riserva il diritto di apportare qualsiasi modifica alla propria produzione senza preavviso.

Sono possibili esecuzioni personalizzate. Sono richiesti minimi d'ordine.

È vietata la riproduzione anche parziale di questo catalogo.

IVELA srl garantisce i prodotti del seguente catalogo per un termine di 2 anni dalla data di acquisto purché installati correttamente, e utilizzati nei limiti e in conformità alle specifiche tecniche dei componenti e alle prescrizioni del foglio di istruzione.

In caso di contestazione si stabilisce la competenza esclusiva dell'Autorità Giudiziaria di Milano.

Ivela si riserva la facoltà di modificare, in qualsiasi momento e senza preavviso, le caratteristiche tecniche dei modelli illustrati nel presente catalogo.

Visita il sito www.ivala.it per le informazioni di prodotto più aggiornate.

Purchase orders are considered accepted at the sale prices and conditions at the time. In the event of a variation in price, terms and conditions at the point of sale, the purchaser shall have the right to cancel the orders placed at this time. Orders must be cancelled within eight days of receipt of such a variation. All purchase orders shall be considered accepted once Ivela have given written confirmation.

All prices quoted in the price list are ex works unless otherwise agreed upon.

Ivela are not liable for the goods at the moment they are handed over to the carrier for shipment. Carriage or shipment of goods by whatever transport or shipping means shall be always considered at the risk and responsibility of the purchaser. Ivela shall not be considered liable for breakages, faults, thefts or alteration to said goods.

Delivery terms agreed upon are always to be considered indicative.

We reserve the right to alter our products without prior notification.

Customizations are possible. Minimum quantities required.

It is forbidden to reproduce any part of this catalogue.

IVELA srl guarantee the products of the current catalogue for a 2 year period from the date of purchase, provided that the installation is correct, and that the products are used within the limits and in conformity with the technical features of their components and with the requirements of the installation sheet.

All orders to which these Conditions of Sale apply, shall be governed by and construed in accordance with Italian Law.

Ivela reserves the right to change, at any time and without prior warning, the technical specifications of any product illustrated in this catalogue.

Please visit www.ivala.it for the latest product info.

Follow us on
Facebook | Instagram | Vimeo

IVELA srl – Member of Starlight Group

Via B. Buozzi, 15 – 20050
Liscate (MI) - Italy
Ph +39 02 9500121
Fax +39 02 95001205
info@ivela.it

ivela.it

Distributore per l'Italia:
Elcom srl - Member of Starlight Group

Art Direction	IVELA Marketing & Communication Dept.
Fotografie	Bordegoni srl Paolo Carlini Photographer Nele Martensen Mattia Aquila Photography Seven Zhang Angelo Talia

Pre-press e stampa	Arti Grafiche Alpine srl
Finito di stampare	2023

Copyright © 2023 - La riproduzione è severamente vietata senza autorizzazione scritta da parte di IVELA srl - Member of Starlight Group

Total reproduction of this catalogue is forbidden without prior written authorization from IVELA srl - Member of Starlight Group.

